

**atom**

**Wholesale Catalogue**

2020-21





# Content

## atom<sup>i</sup>

### LED DOWNLIGHTS

SMART CONNECTED DOWNLIGHTS	9 - 10
RECESSED DOWNLIGHTS	11 - 33
SURFACE MOUNT DOWNLIGHTS	34 - 35
TRACK SPOT LIGHTING	36 - 37
DOWNLIGHT TRIM KIT	38
ACCESSORIES	39 - 41

### LED OYSTERS

WIZ CONNECTED PRO	45 - 46
TRI COLOUR OYSTERS	47 - 52
DIMMABLE OYSTERS	53 - 54
ACCESSORIES	55

### LED STRIPS

LED STRIPS KITS	59
SHALLOW EXTRUSIONS KITS	60
DEEP EXTRUSIONS KITS	60
CORNER EXTRUSIONS KITS	61
ACCESSORIES	61

### LED STEPS LIGHTS

SQUARE OPAL RECESSED STEP LIGHT	64
SQUARE CLEAR RECESSED STEP LIGHT	64
RECTANGULAR OPAL RECESSED STEP LIGHT	65
RECTANGULAR CLEAR RECESSED STEP LIGHT	65

### LED BUNKERS

CORRIDOR FUNCTION LED BUNKERS	68
TRI COLOUR LED BUNKERS	69 - 70
LED BUNKERS OVAL	71
LED BUNKERS ROUND	72
LED BUNKERS RECTANGLE	73

### LED LAMPS

WIZ CONNECTED PRO	77 - 79
LED GLS LAMPS	80 - 81
LED CANDLE LAMPS	82 - 83
LED STICK LAMPS	83
LED G95 LAMPS	84
LED G120 LAMPS	85
LED G45 LAMPS	86
LED R63/R80 LAMPS	87
LED GU10 LAMPS	88
LED MR16 LAMPS	89
LED ST64 LAMPS	90 - 91
LED PAR38 LAMPS	92
LED LAMPS WITH DRIVER	92
ACCESSORIES	93

### LED EXTERIOR AND WORKLIGHTS

UP/DOWN EXTERIOR LIGHTS	96
WALL SPOTS EXTERIOR LIGHTS	97
SPOTLIGHTS	98
SPOTLIGHTS WITH SENSOR	99
GARDEN SPIKES	100 - 101
BOLLARDS	102
WORKLIGHTS	103

### COMMERCIAL LIGHTING

BACKLIT PANELS	106 - 107
TROFFER	108 - 109
FLOODLIGHTS	110 - 114
HIGHBAYS	115 - 116
WEATHERPROOF BATTENS	117 - 118
DIFFUSED BATTENS	119 - 120
WIRE GUARDS BATTENS	121
ACCESSORIES	122 - 123

### DRIVERS AND ACCESSORIES

WEATHERPROOF DRIVERS	126
CONSTANT VOLTAGE DRIVERS	126 - 127
VOLTAGE DRIVERS	127
CONSTANT CURRENT DRIVERS	127
DIMMERS	128

VALUE, INNOVATION, QUALITY

atom<sup>i</sup>

Originating in Queensland Atom Lighting is a major player in the lighting industry, with a high level of service and continual introduction of new products.

Through constant product development and testing, Atom not only focuses on the everyday needs of the market, but in technology, innovation and ensuring Atom products continue to challenge the norm in the industry.

New product development for Atom includes easy to install products that survive in the extreme environments found in Australia and New Zealand.







## LED Downlights

LED Downlights are a great energy-saving light with a range of sizes, brightness and application abilities. For a light that fits perfectly into residential and commercial applications and with so many options, LED Downlights are the choice for you.

# Overview

## LED DOWNLIGHTS

SMART CONNECTED DOWNLIGHTS	9 - 10
RECESSED DOWNLIGHTS	11 - 33
SURFACE MOUNT DOWNLIGHTS	34 - 35
TRACK SPOT LIGHTING	36 - 37
DOWNLIGHT TRIM KIT	38
ACCESSORIES	39 - 41









## AT4010/WIZ

10W LED Downlight WiZ Connected Pro - Flush lens

### Product specification

<b>Voltage</b>	230~50Hz
<b>Power consumption</b>	10W
<b>Dimmable</b>	Yes*
<b>Light colour options</b>	RGB (64,000 Whites + 16 Million Colours) Tunable White
<b>Colour temperature</b>	3000K - 5700K + RGB
<b>Beam angle</b>	90°
<b>IP Rating</b>	IP44 (Front face only)
<b>IC Rating</b>	IC - 4

\*Via the App or voice control. For additional information please visit our website

### Product range

Code	Description
<b>AT4010/WH/WIZ/TR</b> SKU: 15331	10W LED Downlight - WiZ Connected Pro - Colours + Adjustable White - White - 820 - 860lm
<b>AT4010/WH/WIZ/TW</b> SKU: 15210	10W LED Downlight - WiZ Connected Pro - Adjustable white - White - 785 - 815lm



> 64,000 WHITES > 16 MILLION COLOURS

### WiZ Pro Enterprise lighting interface

#### SET THE RULES AND SUPERVISE

Control multiple rooms and floors, pre-program schedules and set scenes

#### ENERGY USAGE MONITORING

Reports can be generated and exported based on each lamp's usage and energy consumption

#### PREDICTIVE MAINTENANCE

Each light reports its usage to the cloud. Lifespan can be calculated to proactively identify and replace fading lights

### Finish

White

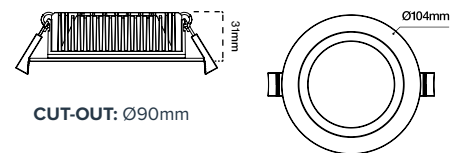

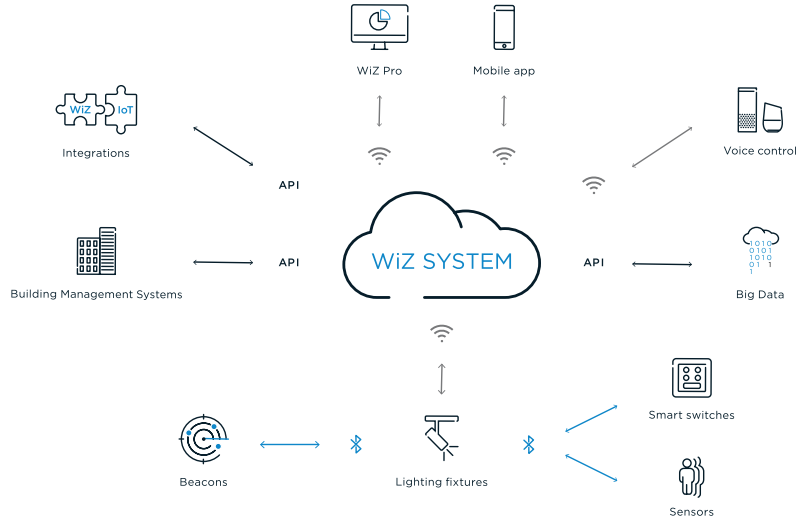

## AT9017/WIZ

10W LED Downlight WiZ Connected Pro

### Product specification

<b>Voltage</b>	230~50Hz
<b>Power consumption</b>	10W
<b>Dimmable</b>	Yes*
<b>Light colour options</b>	RGB (64,000 Whites + 16 Million Colours) Tunable White
<b>Colour temperature</b>	3000K - 5700K + RGB
<b>Beam angle</b>	90°
<b>IP Rating</b>	IP54 (Front face only)
<b>IC Rating</b>	IC - 4

\*Via the App or voice control. For additional information please visit our website

### Product range

Code	Description
<b>AT9017/WH/WIZ/TR</b> SKU: 15078	10W LED Downlight - WiZ Connected Pro - Colours + Adjustable White - White - 740 - 760lm
<b>AT9017/WH/WIZ/TW</b> SKU: 15082	10W LED Downlight - WiZ Connected Pro - Adjustable white - White - 720 - 750lm

> 64,000 WHITES > 16 MILLION COLOURS

### WiZ Pro Enterprise lighting interface

#### SET THE RULES AND SUPERVISE

Control multiple rooms and floors, pre-program schedules and set scenes

#### ENERGY USAGE MONITORING

Reports can be generated and exported based on each lamp's usage and energy consumption

#### PREDICTIVE MAINTENANCE

Each light reports its usage to the cloud. Lifespan can be calculated to proactively identify and replace fading lights

### Finish

White

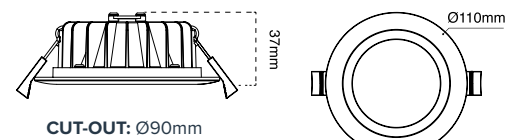



**Finish**

White

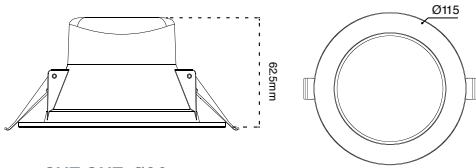

CUT-OUT: Ø90mm

## AT9039/TRI

8W LED Downlight with Dimmable Integral Driver- Tri Colour

**Product specification**

<b>Voltage</b>	230~50Hz
<b>Power consumption</b>	8W
<b>Dimmable</b>	Yes
<b>Light colour options</b>	Tri Colour
<b>Colour temperature</b>	3000, 4000K & 5700K
<b>Beam angle</b>	90°
<b>IP Rating</b>	IP44 (Front face only)
<b>IC Rating</b>	IC - 4

**Product range**

Code	Description
AT9039/WH/TRI SKU: 14536	8W LED Downlight with Dimmable Integral Driver - White - Tri Colour - 670 - 755lm



**Finish**

White

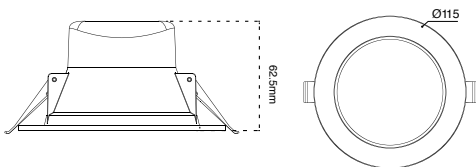

CUT-OUT: Ø90mm

## AT9039

8W LED Downlight with Dimmable Integral Driver

**Product specification**

<b>Voltage</b>	230~50Hz
<b>Power consumption</b>	8W
<b>Dimmable</b>	Yes
<b>Light colour options</b>	Warm white, Cool white
<b>Colour temperature</b>	3000K 4000K
<b>Beam angle</b>	90°
<b>IP Rating</b>	IP44 (Front face only)
<b>IC Rating</b>	IC - 4

**Product range**

Code	Description
AT9039/WH/WW SKU: 11396	8W LED Downlight with Dimmable Integral Driver - White - Warm white - 750lm
AT9039/WH/CW SKU: 11458	8W LED Downlight with Dimmable Integral Driver - White - Cool white - 750lm

## AT9039/F/TRI

8W LED Downlight with Dimmable Integral Driver- Tri Colour



### Finish

White

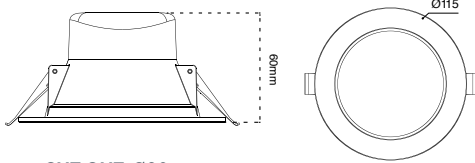

CUT-OUT: Ø90mm

### Product specification

<b>Voltage</b>	230~50Hz
<b>Power consumption</b>	8W
<b>Dimmable</b>	Yes
<b>Light colour options</b>	Tri Colour
<b>Colour temperature</b>	3000, 4000K & 5700K
<b>Beam angle</b>	90°
<b>IP Rating</b>	IP44 (Front face only)
<b>IC Rating</b>	IC - 4

### Product range

Code	Description
<b>AT9039/WH/F/TRI</b> SKU: 11269	8W LED Downlight with Dimmable Integral Driver - White - Flush Lens - Tri Colour - 670 - 755lm



### Finish

White

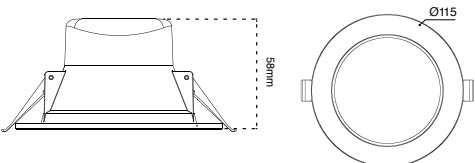

CUT-OUT: Ø90mm

## AT9039/FLUSH

8W LED Downlight with Dimmable Integral Driver

### Product specification

<b>Voltage</b>	230~50Hz
<b>Power consumption</b>	8W
<b>Dimmable</b>	Yes
<b>Light colour options</b>	Warm white, Cool white
<b>Colour temperature</b>	3000K 4000K
<b>Beam angle</b>	90°
<b>IP Rating</b>	IP44 (Front face only)
<b>IC Rating</b>	IC - 4

### Product range

Code	Description
<b>AT9039/WH/F/WW</b> SKU: 12383	8W LED Downlight with Dimmable Integral Driver - White - Flush Lens - Warm white - 700lm
<b>AT9039/WH/F/CW</b> SKU: 12389	8W LED Downlight with Dimmable Integral Driver - White - Flush Lens - Cool white - 750lm



## AT9012/TRI

12W LED Downlight supplied with Dimmable Driver- Tri Colour

### Product specification

<b>Voltage</b>	230~50Hz
<b>Power consumption</b>	12W
<b>Dimmable</b>	Yes
<b>Light colour options</b>	Tri Colour
<b>Colour temperature</b>	3000, 4000K & 6000K
<b>Beam angle</b>	90°
<b>IP Rating</b>	IP44 (Front face only)
<b>IC Rating</b>	IC - 4

### Product range

Code	Description
<b>AT9012/WH/TRI</b> SKU: 11148	12W LED Downlight with Dimmable Driver - 90° beam - White - TRI
<b>AT9012/BLK/TRI</b> SKU: 11060	12W LED Downlight with Dimmable Driver - 90° beam - Black - TRI - 910 - 1035lm
<b>AT9012/SIL/TRI</b> SKU: 11099	12W LED Downlight with Dimmable Driver - 90° beam - Silver - TRI - 910 - 1035lm
<b>AT9012/AND/TRI</b> SKU: 11075	12W LED Downlight with Dimmable Driver - 90° beam - Anodised aluminium - TRI - 910 - 1035lm
<b>AT9012/SC/TRI</b> SKU: 11218	12W LED Downlight with Dimmable Driver - 90° beam - Satin chrome - TRI - 910 - 1035lm



### Finish

- White
- Black
- Silver
- Satin chrome
- Anodised aluminium

### Accessories

**AT9018**  
140mm extension plate. Available in white, black and satin chrome

**AT9019**  
170mm extension plate. Available in white and satin chrome

For full product list see pages 39 - 41

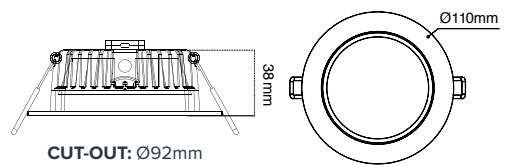



## AT9012/COB

12W Fixed COB LED Downlight with Dimmable Driver

### Product specification

<b>Voltage</b>	230~50Hz
<b>Power consumption</b>	12W
<b>Dimmable</b>	Yes
<b>Light colour options</b>	Warm white, & Cool white
<b>Colour temperature</b>	3000K & 4000K
<b>Beam angle</b>	90°
<b>IP Rating</b>	IP44
<b>IC Rating</b>	IC - 4

### Product range

Code	Description
AT9012/WH/COB/WW SKU: 11146	12W Fixed COB LED Downlight - White - Warm white - 1020lm
AT9012/WH/COB/CW SKU: 11133	12W Fixed COB LED Downlight - White - Cool white - 1070lm

### Finish

White

### Accessories

#### AT9018

140mm extension plate. Available in white, black and satin chrome

#### AT9019

170mm extension plate. Available in white and satin chrome

For full product list see pages 39 - 41

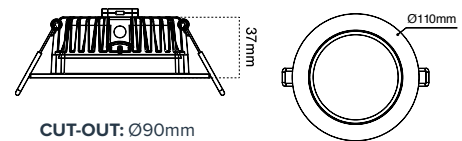



## AT9012/FR

12W Fired rated LED Downlight with Dimmable Driver

### Product specification

<b>Voltage</b>	230~50Hz
<b>Power consumption</b>	12W
<b>Dimmable</b>	Yes
<b>Light colour options</b>	Warm white & Cool white
<b>Colour emperature</b>	3000K & 4000K
<b>Beam angle</b>	120°
<b>IP Rating</b>	IP65 (Front face only)
<b>IC Rating</b>	IC - 4
<b>Fire Rating</b>	_/120/120*

### Product range

Code	Description
<b>AT9012/WH/FR/WW</b> SKU: 11434	12W LED Fire rated Downlight with dimmable driver - Warm white - White - 900lm
<b>AT9012/WH/FR/CW</b> SKU: 11426	12W LED Fire rated Downlight with dimmable driver - Cool white - White - 960lm

\* Standard fire rated platerboard / steel. Check application suitability prior to purchase.



### Finish

White

### Recommended dimmers

**AT9302**  
200W Trailing - edge LED Dimmer mechanism

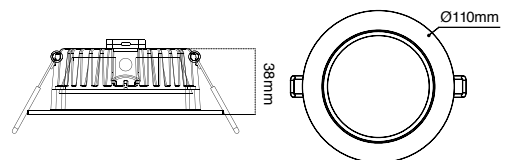



### Finish

White

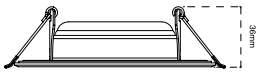

CUT-OUT: Ø80mm - Ø110mm

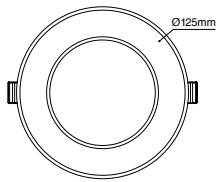

## AT9034/LT

12W LED Downlight supplied with Dimmable Driver - Large Trim

### Product specification

<b>Voltage</b>	230~50Hz
<b>Power consumption</b>	12W
<b>Dimmable</b>	Yes
<b>Light colour options</b>	Warm white & Cool white
<b>Colour temperature</b>	3000K & 4000K
<b>Beam angle</b>	120°
<b>IP Rating</b>	IP44 (Front face only)
<b>IC Rating</b>	IC - 4

### Product range

Code	Description
<b>AT9034/LT/WH/WW</b> SKU: 11373	12W LED Downlight with Dimmable Driver - Large Trim 125mm - White - Warm white - 855lm
<b>AT9034/LT/WH/CW</b> SKU: 11194	12W LED Downlight with Dimmable Driver - Large Trim 125mm - White - Cool white - 845lm



### Finish

White    Satin chrome



CUT-OUT: Ø90mm

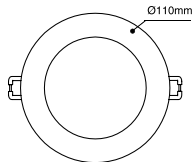

## AT9034

12W LED Downlight supplied with Dimmable Driver

### Product specification

<b>Voltage</b>	230~50Hz
<b>Power consumption</b>	12W
<b>Dimmable</b>	Yes
<b>Light colour options</b>	Warm white, Cool white & Daylight
<b>Colour temperature</b>	3000K 4000K & 5000K
<b>Beam angle</b>	120°
<b>IP Rating</b>	IP44 (Front face only)
<b>IC Rating</b>	IC - 4

### Product range

Code	Description
<b>AT9034/WH/WW</b> SKU: 11817	12W LED Downlight with Dimmable Driver - 110° beam - White - Warm white - 780lm
<b>AT9034/WH/CW</b> SKU: 12000	12W LED Downlight with Dimmable Driver - 110° beam - White - Cool white - 780lm
<b>AT9034/WH/DL</b> SKU: 11235	12W LED Downlight with Dimmable Driver - 110° beam - White - Daylight - 780lm
<b>AT9034/SC/WW</b> SKU: 12358	12W LED Downlight with Dimmable Driver - 110° beam - Satin chrome - Warm white - 780lm
<b>AT9034/SC/CW</b> SKU: 12230	12W LED Downlight with Dimmable Driver - 110° beam - Satin chrome - Cool white - 780lm





## ALTIUS

7W LED Downlight Quad colour with interchangeable trims

### Product specification

<b>Voltage</b>	230~50Hz
<b>Power consumption</b>	7W
<b>Dimmable</b>	Yes
<b>Light colour options</b>	Warm white, Cool white, Natural & Daylight
<b>Colour temperature</b>	3000, 3500K, 4000K & 5000K
<b>Beam angle</b>	100°
<b>IP Rating</b>	IP44 (Front face only)
<b>IC Rating</b>	IC - 4

### Product range

Code	Description
<b>ALTIUS 18700</b> SKU: 18700	7W LED Downlight with dimmable driver - Interchangeable trims - 100° - F&P - White - 4-CCT - 715 - 800lm

### Finish

White

### Accessories

**ALTIUS 18723**  
SKU: 18723  
Black flush trim for Altius 18700

**ALTIUS 18774**  
SKU: 18774  
Black recessed trim for Altius 18700

**ALTIUS 18746**  
SKU: 18746  
Satin nickel trim for Altius 18700

**ALTIUS 18797**  
SKU: 18797  
Satin nickel flush trim for Altius 18700

For full product list see pages 39 - 41

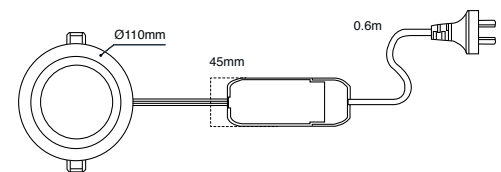

### Flush

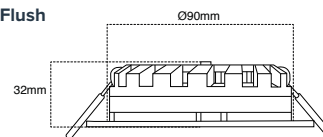

### Recessed

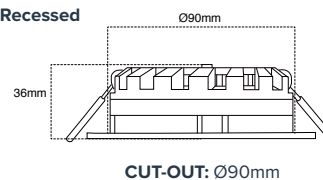



### Finish

- White
- Satin chrome
- Black
- Silver

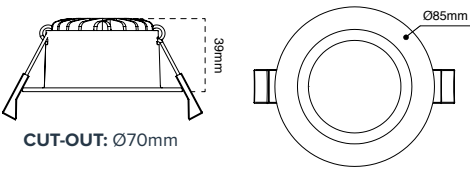

### Finish

- White

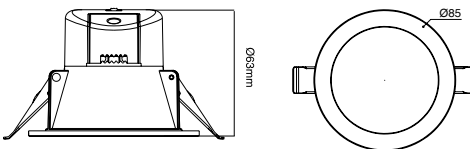

CUT-OUT: Ø70mm

## AT9023/TRI

7W LED Downlight supplied with Dimmable Driver- Tri Colour

### Product specification

<b>Voltage</b>	230~50Hz
<b>Power consumption</b>	7W
<b>Dimmable</b>	Yes
<b>Light colour options</b>	Tri Colour
<b>Colour temperature</b>	3000 - 5000K
<b>Beam angle</b>	90°
<b>IP Rating</b>	IP54 (Front face only)
<b>IC Rating</b>	IC - 4

### Product range

Code	Description
<b>AT9023/WH/TRI</b> SKU: 10991	7W LED Downlight with Dimmable Driver - 90° beam - White - TRI - 910 - 1035lm
<b>AT9023/BLK/TRI</b> SKU: 14903	7W LED Downlight with Dimmable Driver - 90° beam - Black - TRI - 910 - 1035lm
<b>AT9023/SIL/TRI</b> SKU: 12538	7W LED Downlight with Dimmable Driver - 90° beam - Silver - TRI - 910 - 1035lm
<b>AT9023/SC/TRI</b> SKU: 12546	7W LED Downlight with Dimmable Driver - 90° beam - Satin Chrome - TRI - 910 - 1035lm

## AT9038/FLUSH/TRI

7W LED Downlight with Dimmable Integral Driver- Tri Colour

### Product specification

<b>Voltage</b>	230~50Hz
<b>Power consumption</b>	7W
<b>Dimmable</b>	Yes
<b>Light colour options</b>	Tri Colour
<b>Colour temperature</b>	3000 - 5700K
<b>Beam angle</b>	90°
<b>IP Rating</b>	IP54 (Front face only)
<b>IC Rating</b>	IC - 4

### Product range

Code	Description
<b>AT9038/WH/F/TRI</b> SKU: 13262	12W LED Square Downlight with Dimmable Driver - 90° beam - White - TRI - 560 - 650lm

# atom



**CUT-OUT**  
Ø70mm

### Finish

□ White    ■ Satin chrome



**CUT-OUT:** Ø70mm

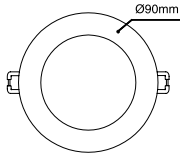

**CUT-OUT**  
Ø125mm

**I PART**    **VEU**

### Finish

□ White

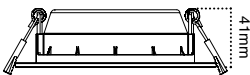

**CUT-OUT:** Ø125mm

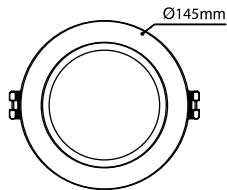

## AT9036

9W LED Downlight with Dimmable Driver

### Product specification

<b>Voltage</b>	230~50Hz
<b>Power consumption</b>	9W
<b>Dimmable</b>	Yes
<b>Light colour options</b>	Warm white & Cool white
<b>Colour temperature</b>	3000K & 4000K
<b>Beam angle</b>	120°
<b>IP Rating</b>	IP44

### Product range

Code	Description
<b>AT9036/WH/WW</b> SKU: 11669	Small 9W LED Downlight with Dimmable Driver - 120° beam - White - Warm white - 530lm
<b>AT9036/WH/CW</b> SKU: 11664	Small 9W LED Downlight with Dimmable Driver - 120° beam - White - Cool white - 600lm
<b>AT9036/SC/CW</b> SKU: 11655	Small 9W LED Downlight with Dimmable Driver - 120° beam - Satin chrome - Daylight - 600lm

## AT9045

12W LED Downlight with Driver

### Product specification

<b>Voltage</b>	230~50Hz
<b>Power consumption</b>	12W
<b>Dimmable</b>	Yes
<b>Light colour options</b>	Warm white, Cool white & Daylight
<b>Colour temperature</b>	3000K 4000K & 5000K
<b>Beam angle</b>	90°
<b>IP Rating</b>	IP44 (Front face only)
<b>IC Rating</b>	IC - 4

### Product range

Code	Description
<b>AT9045/WH/WW</b> SKU: 10459	12W LED Downlight with Driver - White - Warm white - 1060lm
<b>AT9045/WH/CW</b> SKU: 10341	12W LED Downlight with Driver - White - Cool white - 1115lm
<b>AT9045/WH/DL</b> SKU: 10577	12W LED Downlight with Driver - White - Daylight - 1140lm

atom



  
CUT-OUT  
Ø165mm

**I PART** **VEU**

**Finish**

White

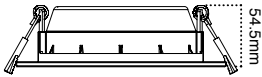

CUT-OUT: Ø165mm

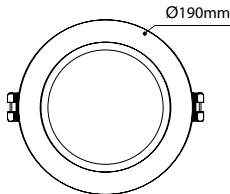

  
CUT-OUT  
Ø200mm

**I PART** **VEU**

**Finish**

White

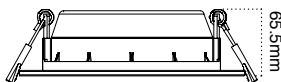

CUT-OUT: Ø200mm

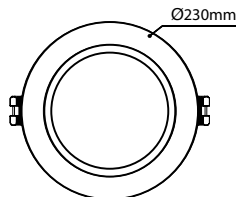

## AT9046

19W LED Downlight with Driver

**Product specification**

<b>Voltage</b>	230~50Hz
<b>Power consumption</b>	19W
<b>Dimmable</b>	Yes
<b>Light colour options</b>	Warm white, Cool white & Daylight
<b>Colour temperature</b>	3000K 4000K & 5000K
<b>Beam angle</b>	90°
<b>IP Rating</b>	IP44 (Front face only)
<b>IC Rating</b>	IC - 4

**Product range**

Code	Description
<b>AT9046/WH/WW</b> SKU: 10585	19W LED Downlight with Driver - White - Warm white - 1680lm
<b>AT9046/WH/CW</b> SKU: 10820	19W LED Downlight with Driver - White - Cool white - 1720lm
<b>AT9046/WH/DL</b> SKU: 10349	19W LED Downlight with Driver - White - Daylight - 1780lm

## AT9047

24W LED Downlight with Driver

**Product specification**

<b>Voltage</b>	230~50Hz
<b>Power consumption</b>	24W
<b>Dimmable</b>	Yes
<b>Light colour options</b>	Warm white, Cool white & Daylight
<b>Colour temperature</b>	3000K 4000K & 5000K
<b>Beam angle</b>	90°
<b>IP Rating</b>	IP44 (Front face only)
<b>IC Rating</b>	IC - 4

**Product range**

Code	Description
<b>AT9047/WH/WW</b> SKU: 10473	24W LED Downlight with Driver - White - Warm white - 2260lm
<b>AT9047/WH/CW</b> SKU: 10827	24W LED Downlight with Driver - White - Cool white - 2280lm
<b>AT9047/WH/DL</b> SKU: 10709	24W LED Downlight with Driver - White - Daylight - 2310lm





### Finish

White
  Satin chrome

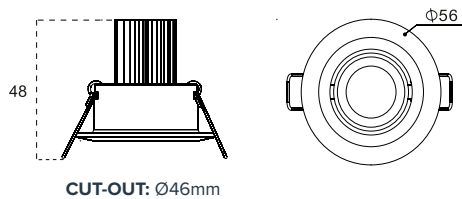

### Finish

White
  Satin chrome

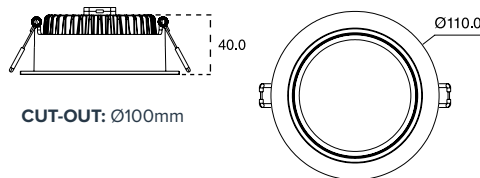

## AT9014

3W LED Adjustable Downlight with Driver

### Product specification

<b>Voltage</b>	230~50Hz
<b>Power consumption</b>	3W
<b>Dimmable</b>	No
<b>Light colour options</b>	Warm white & Cool white
<b>Colour temperature</b>	3000K & 4000K
<b>Beam angle</b>	45°
<b>IP Rating</b>	IP20
<b>IC Rating</b>	IC

### Product range

Code	Description
<b>AT9014/SC/WW</b> SKU: 10640	3W LED Adjustable Downlight 45° beam - Cool White - Satin chrome with Driver - 155lm
<b>AT9014/SC/CW</b> SKU: 10404	3W LED Adjustable Downlight 45° beam - Cool White - Satin chrome with Driver - 185lm
<b>AT9014/WH/WW</b> SKU: 10279	3W LED Adjustable Downlight 45° beam - Cool White - White Finish with Driver - 155lm
<b>AT9014/WH/CW</b> SKU: 10632	3W LED Adjustable Downlight 45° beam - Cool White - White Finish with Driver - 185lm

## AT9020

13W LED Adjustable Downlight with Dimmable Driver

### Product specification

<b>Voltage</b>	230~50Hz
<b>Power consumption</b>	13W
<b>Dimmable</b>	Yes
<b>Light colour options</b>	Warm white & Cool white
<b>Colour temperature</b>	3000K & 4000K
<b>Beam angle</b>	90°
<b>IP Rating</b>	IP20
<b>IC Rating</b>	IC

### Product range

Code	Description
<b>AT9020/SC/WW</b> SKU: 10658	13W LED Adjustable Downlight - Satin chrome - with Dimmable Driver - Cool white - 965lm
<b>AT9020/SC/CW</b> SKU: 10422	13W LED Adjustable Downlight - Satin chrome - with Dimmable Driver - Cool white - 1020lm
<b>AT9020/WH/WW</b> SKU: 10652	13W LED Adjustable Downlight - White - with Dimmable Driver - Cool white - 965lm
<b>AT9020/WH/CW</b> SKU: 10534	13W LED Adjustable Downlight - White - with Dimmable Driver - Cool white - 1020lm



**Finish**

White

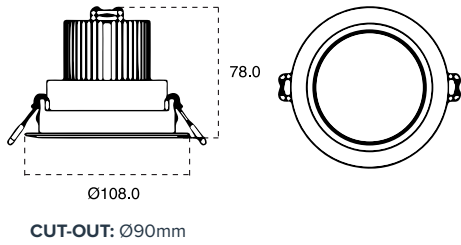

**Finish**

White     Satin chrome

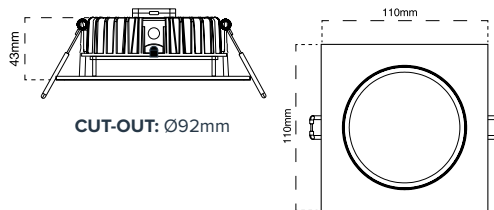

## AT9015

15W High Powered LED Fixed Downlight with Dimmable Driver

**Product specification**

<b>Voltage</b>	230~50Hz
<b>Power consumption</b>	15W
<b>Dimmable</b>	Yes
<b>Light colour options</b>	Warm white & Cool white
<b>Colour temperature</b>	3000K & 4000K
<b>Beam angle</b>	90°
<b>IP Rating</b>	IP20
<b>IC Rating</b>	IC - 4

**Product range**

Code	Description
<b>AT9015/WH/WW</b> SKU: 10663	15W High Powered LED Fixed Downlight- 3000K - Dimmable Driver - White - 970lm
<b>AT9015/WH/CW</b> SKU: 10781	15W High Powered LED Fixed Downlight- 4000K - Dimmable Driver - White - 1070lm

## AT9021/TRI

12W LED Square Downlight with Dimmable Driver- Tri Colour

**Product specification**

<b>Voltage</b>	230~50Hz
<b>Power consumption</b>	12W
<b>Dimmable</b>	Yes
<b>Light colour options</b>	Tri Colour
<b>Colour temperature</b>	3000, 4000K & 6000K
<b>Beam angle</b>	90°
<b>IP Rating</b>	IP44 (Front face only)
<b>IC Rating</b>	IC - 4

**Product range**

Code	Description
<b>AT9021/WH/TRI</b> SKU: 10671	12W LED Square Downlight with Dimmable Driver - 90° beam - White - TRI - 1040 - 1120lm
<b>AT9021/SC/TRI</b> SKU: 10655	12W LED Square Downlight with Dimmable Driver - 90° beam - Satin chrome - TRI - 1040 - 1120lm



### Finish

White

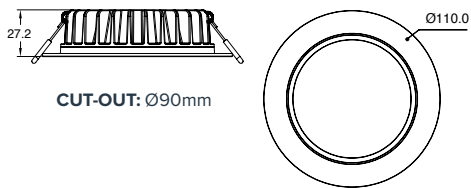

## AT9027

9W LED Flush Lens Downlight with Dimmable Driver

### Product specification

<b>Voltage</b>	230~50Hz
<b>Power consumption</b>	9W
<b>Dimmable</b>	Yes
<b>Light colour options</b>	Warm white, & Cool white
<b>Colour temperature</b>	3000K & 4000K
<b>Beam angle</b>	90°
<b>IP Rating</b>	IP20
<b>IC Rating</b>	IC - 4

### Product range

Code	Description
<b>AT9027/WH/WW</b> SKU: 10528	9W LED Flush Lens Downlight with Dimmable Driver - White - Warm white - 640lm
<b>AT9027/WH/CW</b> SKU: 10646	9W LED Flush Lens Downlight with Dimmable Driver - White - Cool white - 815lm



### Finish

White

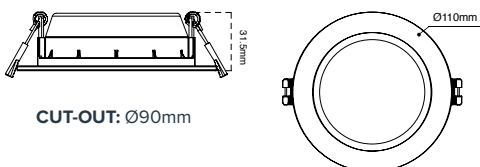

## AT9032

10W LED Plastic Trim Downlight with Dimmable Driver

### Product specification

<b>Voltage</b>	230~50Hz
<b>Power consumption</b>	10W
<b>Dimmable</b>	Yes
<b>Light colour options</b>	Warm white, Cool white & Daylight
<b>Colour temperature</b>	3000K 4000K & 5000K
<b>Beam angle</b>	90°
<b>IP Rating</b>	IP44 (Front face only)
<b>IC Rating</b>	IC - 4

### Product range

Code	Description
<b>AT9032/WH/WW</b> SKU: 11874	10W LED Plastic trim Downlight with Dimmable driver - White - Warm white - 720lm
<b>AT9032/WH/CW</b> SKU: 10216	10W LED Plastic trim Downlight with Dimmable driver - White - Cool white - 890lm
<b>AT9032/WH/DL</b> SKU: 10222	10W LED Plastic trim Downlight with Dimmable driver - White - Daylight - 770lm





## AT9044

40W Adjustable LED Round Recessed Scoop with Dimmable Driver

### Product specification

<b>Voltage</b>	230~50Hz
<b>Power consumption</b>	40W
<b>Dimmable</b>	Yes
<b>Light colour options</b>	Cool white
<b>Colour temperature</b>	4000K
<b>Beam angle</b>	60°
<b>IP Rating</b>	IP20
<b>IC Rating</b>	IC

### Product range

Code	Description
AT9044/WH/60/CW SKU: 10500	40W Adjustable LED Round Recessed Scoop with Dimmable Driver - White - Cool white - 3600lm

### Finish

White

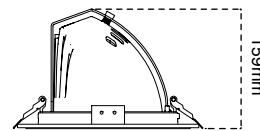

CUT-OUT: Ø170mm

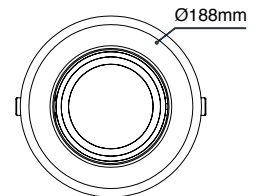



### Finish

White

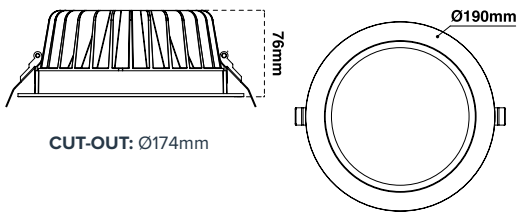

## AT9060

20W LED Recessed Downlight with Driver

### Product specification

<b>Voltage</b>	230~50Hz
<b>Power consumption</b>	20W
<b>Dimmable</b>	Yes
<b>Light colour options</b>	Warm white, Cool white & Daylight
<b>Colour temperature</b>	3000K 4000K & 5000K
<b>Beam angle</b>	90°
<b>IP Rating</b>	IP54 (Front face only)
<b>IC Rating</b>	IC - 4

### Product range

Code	Description
<b>AT9060/WH/WW</b> SKU: 15148	20W LED Recessed Downlight with Driver - White - Warm white - 1835lm
<b>AT9060/WH/CW</b> SKU: 15060	20W LED Recessed Downlight with Driver - White - Cool white - 1915lm
<b>AT9060/WH/DL</b> SKU: 15769	20W LED Recessed Downlight with Driver - White - Daylight - 1920lm



### Finish

White

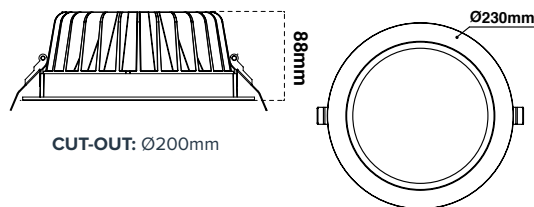

## AT9061

30W LED Downlight with Driver

### Product specification

<b>Voltage</b>	230~50Hz
<b>Power consumption</b>	30W
<b>Dimmable</b>	Yes
<b>Light colour options</b>	Warm white, Cool white & Daylight
<b>Colour temperature</b>	3000K 4000K & 5000K
<b>Beam angle</b>	90°
<b>IP Rating</b>	IP54 (Front face only)
<b>IC Rating</b>	IC - 4

### Product range

Code	Description
<b>AT9061/WH/WW</b> SKU: 16407	30W LED Recessed Downlight with Driver - White - Warm white - 2860lm
<b>AT9061/WH/CW</b> SKU: 16197	30W LED Recessed Downlight with Driver - White - Cool white - 2715lm
<b>AT9061/WH/DL</b> SKU: 16542	30W LED Recessed Downlight with Driver - White - Daylight - 2760lm



## AT1204/15 & AT1204/25

15W LED 60° Lamp comes with Dimmable Driver

### Product specification

<b>Voltage</b>	230~50Hz
<b>Power consumption</b>	15W & 25W
<b>Dimmable</b>	Yes
<b>Light colour options</b>	Warm white & Cool white
<b>Colour temperature</b>	3000K & 4000K
<b>Beam angle</b>	60°
<b>IP Rating</b>	IP20

### Product range

Code	Description
<b>AT1204/15/60/WW</b> SKU: 10939	15W LED 60° Lamp comes with Dimmable Driver - 3000K - 1090lm
<b>AT1204/15/60/CW</b> SKU: 10935	15W LED 60° Lamp comes with Dimmable Driver - 3000K - 1115lm
<b>AT1204/25/60/WW</b> SKU: 10968	25W LED 60° Lamp comes with Dimmable Driver - 4000K - 1816lm
<b>AT1204/25/60/CW</b> SKU: 10944	25W LED 60° Lamp comes with Dimmable Driver - 4000K - 1860lm

### Finish

■ Black

### Accessories

**AT1214**  
SKU: 10926  
125mm White Recessed Downlight reflector to suit AT1204

**AT1234**  
SKU: 10942  
138mm White Recessed Wall Washer reflector to suit AT1204

For full product list see pages 39 - 41

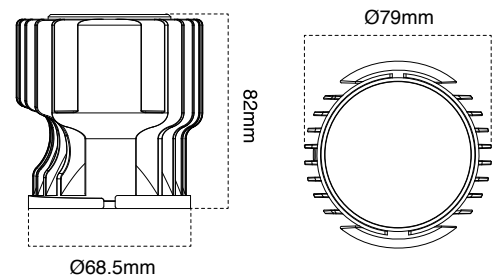



# atom



### Finish

White
  Satin chrome

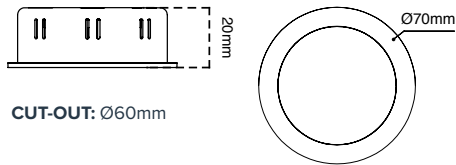

### Compatible drivers

**AT9601**  
 SKU: 10147  
 6W 12Vdc Constant voltage LED Driver (1 fitting max.)

**AT9602**  
 SKU: 10174  
 10W 12Vdc Constant voltage LED Driver (2 fittings max.)

**AT9603**  
 SKU: 10259  
 20W 12Vdc Constant voltage LED Driver (4 fittings max.)



### Finish

White

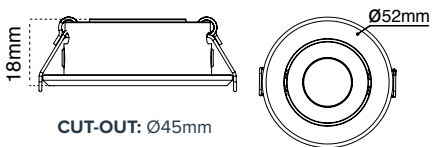

### Compatible LED drivers

**AT9621**  
 SKU: 10201  
 6W 700mA Constant current dimmable driver (1 - 2 fittings)

**AT9628**  
 SKU: 10784  
 18W 700mA Constant current dimmable driver (4 - 6 fittings)

## AT9011

3W LED 12Vdc Cabinet Light

### Product specification

<b>Voltage</b>	12Vdc
<b>Power consumption</b>	3W
<b>Dimmable</b>	No
<b>Light colour options</b>	Warm white & Cool white
<b>Colour temperature</b>	3000 & 4000K
<b>Beam angle</b>	90°
<b>IP Rating</b>	IP20
<b>IC Rating</b>	IC - 4

### Product range

Code	Description
<b>AT9011DC/SC/CW</b> SKU: 10866	3W LED 12V d.c. Shelf Light Cool White - Satin chrome - 305lm
<b>AT9011DC/SC/WW</b> SKU: 10867	3W LED 12V d.c. Shelf Light Cool White - Satin chrome - 200lm
<b>AT9011DC/WH/CW</b> SKU: 10870	3W LED 12V d.c. Shelf Light Cool White - White - 305lm
<b>AT9011DC/WH/WW</b> SKU: 10871	3W LED 12V d.c. Shelf Light Cool White - White - 200lm

## AT9025

3W LED Shelf Light

### Product specification

<b>Voltage</b>	3Vdc
<b>Power consumption</b>	3W
<b>Dimmable</b>	No
<b>Light colour options</b>	Warm white & Cool white
<b>Colour temperature</b>	3000 & 4000K
<b>Beam angle</b>	45°
<b>IP Rating</b>	IP20

### Product range

Code	Description
<b>AT9025/WH/CW</b> SKU: 10226	3W LED shelf light - White Trim - Cool White - 185lm
<b>AT9025/WH/WW</b> SKU: 10229	3W LED shelf light - White Trim - Warm White - 155lm

atom



Finish

White

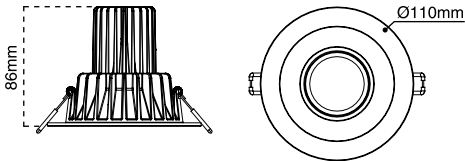

CUT-OUT: Ø90mm



Finish

White

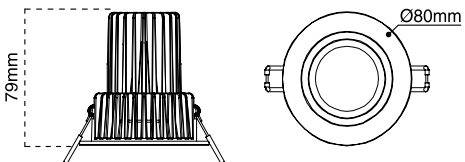

CUT-OUT: Ø70mm

## AT9029/ADJ

12W LED COB Adjustable Downlight with Dimmable Driver

Product specification

Voltage	230~50Hz
Power consumption	12W
Dimmable	Yes
Light colour options	Cool white
Colour temperature	4000K
Beam angle	60°
IP Rating	IP44 (Front face only)
IC Rating	IC - 4

Product range

Code	Description
AT9029/ADJ/WH/WW SKU: 18851	12W LED COB Adjustable Downlight with Dimmable Driver - White - Warm white - 800lm
AT9029/ADJ/WH/CW SKU: 10247	12W LED COB Adjustable Downlight with Dimmable Driver - White - Cool white - 915lm

## AT9029/SML

12W LED COB Downlight with Dimmable Driver

Product specification

Voltage	230~50Hz
Power consumption	12W
Dimmable	Yes
Light colour options	Cool white
Colour temperature	4000K
Beam angle	60°
IP Rating	IP44 (Front face only)
IC Rating	IC - 4

Product range

Code	Description
AT9029/SML/WH/CW SKU: 11607	12W LED COB Downlight with Dimmable Driver - White - Flush Lens - Cool white - 885lm



**Finish**

White

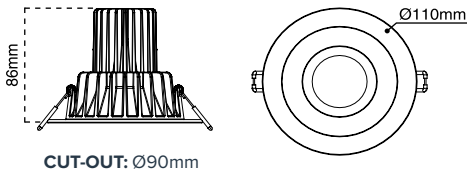

**Finish**

White

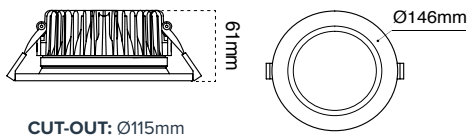

## AT9029

12W LED COB Downlight with Dimmable Driver

**Product specification**

<b>Voltage</b>	230~50Hz
<b>Power consumption</b>	12W
<b>Dimmable</b>	Yes
<b>Light colour options</b>	Warm white & Cool white
<b>Colour temperature</b>	3000K & 4000K
<b>Beam angle</b>	60°
<b>IP Rating</b>	IP44 (Front face only)
<b>IC Rating</b>	IC - 4

**Product range**

Code	Description
AT9029/WH/WW SKU: 10652	12W LED COB Downlight with Dimmable Driver - White - Warm white - 755lm
AT9029/WH/CW SKU: 10534	12W LED COB Downlight with Dimmable Driver - White - Cool white - 885lm

## AT9087/15

15W LED COB Downlight with Dimmable Driver- Tri Colour

**Product specification**

<b>Voltage</b>	230~50Hz
<b>Power consumption</b>	15W
<b>Dimmable</b>	Yes
<b>Light colour options</b>	Tri Colour
<b>Colour temperature</b>	3000 - 5000K
<b>Beam angle</b>	60°
<b>IP Rating</b>	IP40 (Front face only)
<b>IC Rating</b>	IC - 4

**Product range**

Code	Description
AT9087/15/WH/TRI SKU: 11180	15W 60° COB Tri - colour Downlight with Dimmable Driver - Tempered Glass and Sil Refl - Tri Colour - 1515 - 1700lm



**Finish**

White

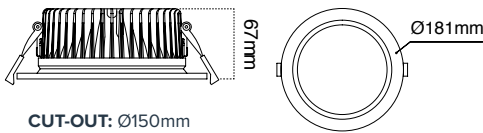

## AT9087/20

20W LED COB Downlight with Dimmable Driver- Tri Colour

**Product specification**

<b>Voltage</b>	230~50Hz
<b>Power consumption</b>	20W
<b>Dimmable</b>	Yes
<b>Light colour options</b>	Tri Colour
<b>Colour temperature</b>	3000 - 5000K
<b>Beam angle</b>	60°
<b>IP Rating</b>	IP40 (Front face only)
<b>IC Rating</b>	IC - 4

**Product range**

Code	Description
AT9087/20/WH/TRI SKU: 11221	20W 60° COB Tri - colour Downlight with Dimmable Driver - Tempered Glass and Sil Refl - Tri Colour - 1890 - 2130lm



**Finish**

White

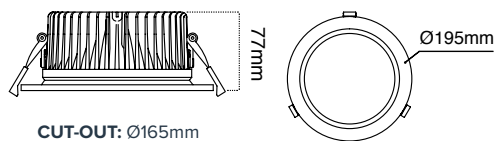

## AT9087/30

30W LED COB Downlight with Dimmable Driver- Tri Colour

**Product specification**

<b>Voltage</b>	230~50Hz
<b>Power consumption</b>	30W
<b>Dimmable</b>	Yes
<b>Light colour options</b>	Tri Colour
<b>Colour temperature</b>	3000 - 5000K
<b>Beam angle</b>	60°
<b>IP Rating</b>	IP40 (Front face only)
<b>IC Rating</b>	IC - 4

**Product range**

Code	Description
AT9087/30/WH/TRI SKU: 11313	30W 60° COB Tri - colour Downlight with Dimmable Driver - Tempered Glass and Sil Refl - Tri Colour - 2720 - 3425lm





## AT9043

35W SMD Rectangular Shop Light with Driver

### Product specification

<b>Voltage</b>	230~50Hz
<b>Power consumption</b>	35W
<b>Dimmable</b>	Yes
<b>Light colour options</b>	Cool white & Daylight
<b>Colour temperature</b>	4000K & 5000K
<b>Beam angle</b>	120°
<b>IP Rating</b>	IP20
<b>IC Rating</b>	IC

### Product range

Code	Description
AT9043/WH/CW SKU: 10715	35W SMD Shop light - White - Cool white - 3380lm
AT9043/WH/DL SKU: 10833	35W SMD Shop light - White - Daylight - 3440lm

### Finish

White

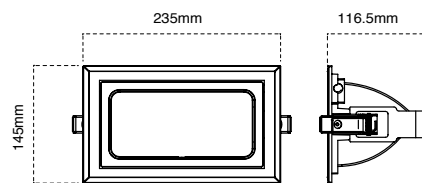

**CUT-OUT:** 220mm x 130mm

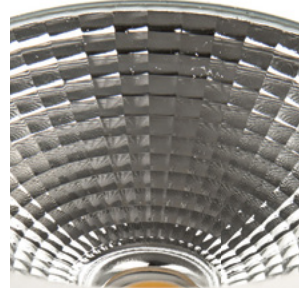

## AT9064

10W LED Dimmable Surface Mount Downlight

### Product specification

<b>Voltage</b>	230~50Hz
<b>Power consumption</b>	10W
<b>Dimmable</b>	Yes
<b>Light colour options</b>	Warm white & Cool white
<b>Colour temperature</b>	3000 & 4000K
<b>Beam angle</b>	60°
<b>IP Rating</b>	IP54 (Front face only)

### Product range

Code	Description
<b>AT9064/WH/60/WW</b> SKU: 10673	10W LED Dimmable Surface Mount Downlight - White - Warm white - 760lm
<b>AT9064/WH/60/CW</b> SKU: 10791	10W LED Dimmable Surface Mount Downlight - White - Cool white - 790lm
<b>AT9064/BLK/60/WW</b> SKU: 10320	10W LED Dimmable Surface Mount Downlight - Black - Warm white - 760lm
<b>AT9064/BLK/60/CW</b> SKU: 10319	10W LED Dimmable Surface Mount Downlight - Black - Cool white - 790lm

### Finish

White Black

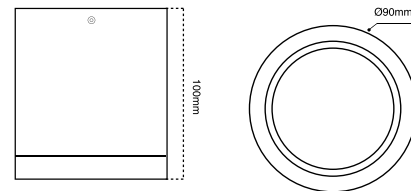

atom<sup>i</sup>



**Finish**

White    Black

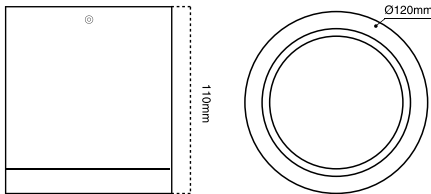

**Finish**

Black

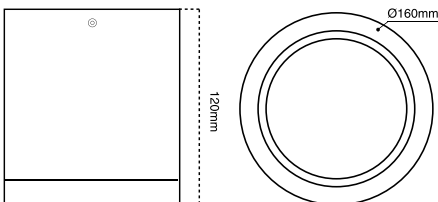

## AT9065

25W LED Dimmable Surface Mount Downlight

**Product specification**

<b>Voltage</b>	230~50Hz
<b>Power consumption</b>	25W
<b>Dimmable</b>	Yes
<b>Light colour options</b>	Warm white & Cool white
<b>Colour temperature</b>	3000 & 4000K
<b>Beam angle</b>	60°
<b>IP Rating</b>	IP54 (Front face only)

**Product range**

Code	Description
AT9065/WH/60/WW SKU: 10593	25W LED Dimmable Surface Mount Downlight - White - 2580lm
AT9065/WH/60/CW SKU: 10475	25W LED Dimmable Surface Mount Downlight - White - 2670lm
AT9065/BLK/60/WW SKU: 10711	25W LED Dimmable Surface Mount Downlight - Black - 2580lm
AT9065/BLK/60/CW SKU: 10710	25W LED Dimmable Surface Mount Downlight - Black - 2670lm

## AT9066

32W LED Dimmable Surface Mount Downlight

**Product specification**

<b>Voltage</b>	230~50Hz
<b>Power consumption</b>	32W
<b>Dimmable</b>	Yes
<b>Light colour options</b>	Warm white & Cool white
<b>Colour temperature</b>	3000 & 4000K
<b>Beam angle</b>	60°
<b>IP Rating</b>	IP54 (Front face only)

**Product range**

Code	Description
AT9066/BLK/60/WW SKU: 10614	32W LED Dimmable Surface Mount Downlight - Black - Warm white - 3275lm
AT9066/BLK/60/CW SKU: 10613	32W LED Dimmable Surface Mount Downlight - Black - Cool white - 3630lm





## AT1107

10W LED Dimmable Track Mounted Spotlight

### Product specification

<b>Voltage</b>	230~50Hz
<b>Power consumption</b>	10W
<b>Dimmable</b>	Yes
<b>Light colour options</b>	Warm white & Cool white
<b>Colour temperature</b>	3000 & 4000K
<b>Beam angle</b>	60°
<b>IP Rating</b>	IP20

### Product range

Code	Description
<b>AT1107/WH/WW</b> SKU: 11704	White Track Mounted adjustable spotlight - Warm white - 900lm
<b>AT1107/WH/CW</b> SKU: 17073	White Track Mounted adjustable spotlight - Cool white - 950lm
<b>AT1107/BLK/WW</b> SKU: 11214	Black Track Mounted adjustable spotlight - Warm white - 810lm
<b>AT1107/BLK/CW</b> SKU: 11227	Black Track Mounted adjustable spotlight - Cool white - 855lm
<b>AT1107/WH/WW/KIT</b> SKU: 18749	White KIT (1m track + 2 spotlights) - Warm white - 900lm
<b>AT1107/WH/CW/KIT</b> SKU: 12830	White KIT (1m track + 2 spotlights) - Cool white - 950lm

### Finish

White
  Black

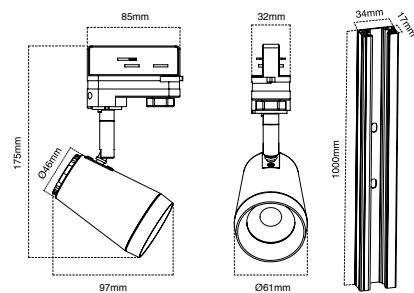

### Accessories

<b>AT1100/1M</b> 3 wire - Track 1m aluminium alloy	<b>AT1100/2M</b> 3 wire - Track 2m aluminium alloy
<b>AT1100/CF</b> 3 wire - Centre feed joiner	<b>AT1100/T</b> 3 wire - T shape joiner
<b>AT1100/STR</b> 3 wire - Straight joiner	<b>AT1100/RA</b> 3 wire - Right angle joiner
<b>AT1100/RAR</b> 3 wire - Right angle right joiner	<b>AT1100/X</b> 3 wire - X shape joiner
<b>AT1100/BEND</b> 3 wire - Bendable joiner	<b>AT1100/DEAD</b> 3 wire - Dead end joiner
<b>AT1100/LIVE</b> 3 wire - Live end joiner	

All accessories are available in white and black. For full product list see pages 39 - 41



## AT1108

12W LED Track Mounted Spotlight

### Product specification

<b>Voltage</b>	230~50Hz
<b>Power consumption</b>	12W, 20W & 30W
<b>Dimmable</b>	No
<b>Light colour options</b>	Warm white & Cool white
<b>Colour temperature</b>	3000 & 4000K
<b>Beam angle</b>	55°
<b>IP Rating</b>	IP20

### Product range

Code	Description
<b>AT1108/12/WH/WW</b> SKU: 11940	12W LED Track Mounted spotlight - 55° beam - White - Warm white - 670lm
<b>AT1108/12/WH/CW</b> SKU: 11934	12W LED Track Mounted spotlight - 55° beam - White - Cool white - 630lm
<b>AT1108/12/BLK/WW</b> SKU: 11917	12W LED Track Mounted spotlight - 55° beam - Black - Cool white - 670lm
<b>AT1108/12/BLK/CW</b> SKU: 11896	12W LED Track Mounted spotlight - 55° beam - Black - Cool white - 630lm
<b>AT1108/20/WH/WW</b> SKU: 12050	20W LED Track Mounted spotlight - 55° beam - White - Warm white - 1210lm
<b>AT1108/20/WH/CW</b> SKU: 12006	20W LED Track Mounted spotlight - 55° beam - White - Cool white - 1180lm
<b>AT1108/20/BLK/WW</b> SKU: 11909	20W LED Track Mounted spotlight - 55° beam - Black - Warm white - 1210lm
<b>AT1108/20/BLK/CW</b> SKU: 11844	20W LED Track Mounted spotlight - 55° beam - Black - Cool white - 1180lm
<b>AT1108/30/WH/WW</b> SKU: 12231	30W LED Track Mounted spotlight - 55° beam - White - Warm white - 1780lm
<b>AT1108/30/WH/CW</b> SKU: 12170	30W LED Track Mounted spotlight - 55° beam - White - Cool white - 1820lm
<b>AT1108/30/BLK/WW</b> SKU: 12061	30W LED Track Mounted spotlight - 55° beam - Black - Warm white - 1780lm
<b>AT1108/30/BLK/CW</b> SKU: 11914	30W LED Track Mounted spotlight - 55° beam - Black - Cool white - 1820lm

### Finish

White Black

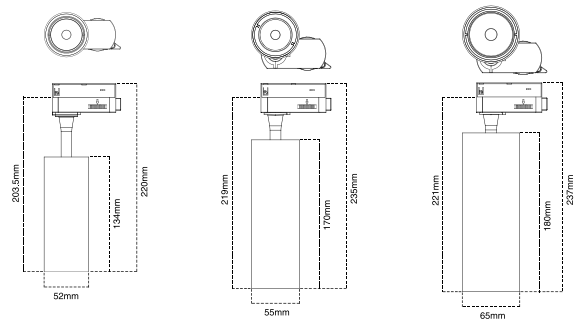

### Accessories

<b>AT1100/1M</b> 3 wire - Track 1m aluminium alloy	<b>AT1100/2M</b> 3 wire - Track 2m aluminium alloy
<b>AT1100/CF</b> 3 wire - Centre feed joiner	<b>AT1100/T</b> 3 wire - T shape joiner
<b>AT1100/STR</b> 3 wire - Straight joiner	<b>AT1100/RA</b> 3 wire - Right angle joiner
<b>AT1100/RAR</b> 3 wire - Right angle right joiner	<b>AT1100/X</b> 3 wire - X shape joiner
<b>AT1100/BEND</b> 3 wire - Bendable joiner	<b>AT1100/DEAD</b> 3 wire - Dead end joiner
<b>AT1100/LIVE</b> 3 wire - Live end joiner	

All accessories are available in white and black. For full product list see pages 39 - 41

## TRACKS



**AT1100/BLK/1M**  
SKU 11345  
3 Wire Track 1m Aluminium Alloy - Black.  
Suitable for *AT1107*



**AT1100/BLK/2M**  
SKU 11359  
3 Wire Track 2m Aluminium Alloy - Black.  
Suitable for *AT1107*



**AT1100/BLK/BEND**  
SKU 16833  
3 Wire - Bendable Joiner - Black.  
Suitable for *AT1107*



**AT1100/BLK/CF**  
SKU 11376  
3 Wire - Straight Joiner Feeder - Black.  
Suitable for *AT1107*



**AT1100/BLK/DEAD**  
SKU 11195  
3 Wire - Dead End - Black.  
Suitable for *AT1107*



**AT1100/BLK/LIVE**  
SKU 11175  
3 Wire - Live End - Black.  
Suitable for *AT1107*



**AT1100/BLK/RA**  
SKU 11415  
3 Wire - Right Angle Joiner Left - Black.  
Suitable for *AT1107*



**AT1100/BLK/RAR**  
SKU 11302  
3 Wire - Right Angle Joiner Right - Black.  
Suitable for *AT1107*



**AT1100/BLK/STR**  
SKU 11393  
3 Wire - Straight Joiner - Black.  
Suitable for *AT1107*



**AT1100/BLK/T**  
SKU 11430  
3 Wire - T Joiner - Black.  
Suitable for *AT1107*



**AT1100/BLK/X**  
SKU 11450  
3 Wire - X Joiner - Black.  
Suitable for *AT1107*

## JOINERS

## TRACKS



**AT1100/WH/1M**  
SKU 18136  
3 Wire Track 1m Aluminium Alloy - White.  
Suitable for **AT1107**



**AT1100/WH/2M**  
SKU 11643  
3 Wire Track 2m Aluminium Alloy - White.  
Suitable for **AT1107**



**AT1100/WH/BEND**  
SKU 14739  
3 Wire - Bendable Joiner - White.  
Suitable for **AT1107**



**AT1100/WH/CF**  
SKU 17149  
3 Wire - Straight Joiner Feeder - White.  
Suitable for **AT1107**



**AT1100/WH/DEAD**  
SKU 18095  
3 Wire - Dead End - White.  
Suitable for **AT1107**



**AT1100/WH/LIVE**  
SKU 16693  
3 Wire - Live End - White.  
Suitable for **AT1107**



**AT1100/WH/RA**  
SKU 11415  
3 Wire - Right Angle Joiner Left - White.  
Suitable for **AT1107**



**AT1100/WH/RAR**  
SKU 11284  
3 Wire - Right Angle Joiner Right - White.  
Suitable for **AT1107**



**AT1100/WH/STR**  
SKU 13416  
3 Wire - Straight Joiner - White.  
Suitable for **AT1107**

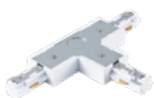

**AT1100/WH/T**  
SKU 15094  
3 Wire - T Joiner - White.  
Suitable for **AT1107**



**AT1100/WH/X**  
SKU 12348  
3 Wire - X Joiner - White.  
Suitable for **AT1107**

## JOINERS



## EXTENSION PLATES



**AT9018/BLK**  
SKU 10117  
140mm Extension Plate - Black.  
Suitable for AT9012

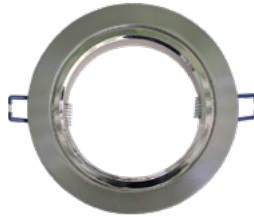

**AT9018/SC**  
SKU 10146  
140mm Extension Plate - Satin chrome.  
Suitable for AT9012

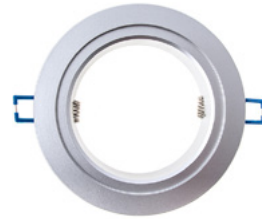

**AT9018/SIL**  
SKU 10119  
140mm Extension Plate - Silver.  
Suitable for AT9012

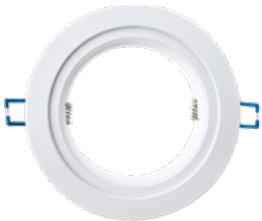

**AT9018/WH**  
SKU 10121  
140mm Extension Plate - White.  
Suitable for AT9012



**AT9019/BLK**  
SKU 10128  
170mm Extension Plate - Black.  
Suitable for AT9012

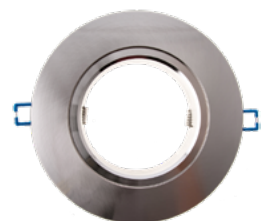

**AT9019/SC**  
SKU 10150  
170mm Extension Plate - Satin chrome.  
Suitable for AT9012

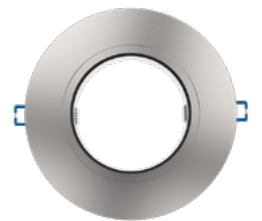

**AT9019/SIL**  
SKU 10126  
170mm Extension Plate - Silver.  
Suitable for AT9012

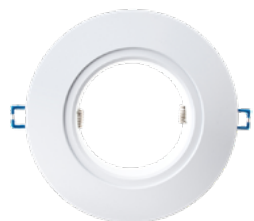

**AT9019/WH**  
SKU 10130  
170mm Extension Plate - White.  
Suitable for AT9012

## TRIMS



**AT9038/BC/F/RING**  
SKU 13345  
Brushed Chrome Trim Flush.  
Suitable for AT9038



**AT9039/BC/F/RING**  
SKU 11096  
Brushed Chrome Trim Flush.  
Suitable for AT9039



**AT9039/BC/RING**  
SKU 12405  
Brushed Chrome Trim.  
Suitable for AT9039



## LED Oysters

LED Oysters are not only a great energy - saving light, they also have a large area of light distribution which means less lights needed. With a range of sizes, brightness and application abilities.

# Overview

## LED OYSTERS

WIZ CONNECTED PRO	45 - 46
TRI COLOUR LED OYSTERS	47 - 52
DIMMABLE LED OYSTERS	53 - 54
ACCESSORIES	55

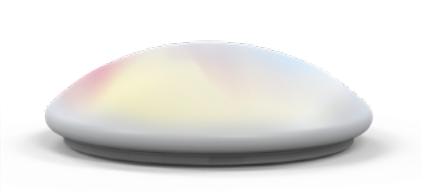





## AT3013/WiZ

16W 350mm Opal acrylic LED Oyster WiZ Connected Pro

### Product specification

<b>Voltage</b>	230~50Hz
<b>Power consumption</b>	16W
<b>Dimmable</b>	Yes*
<b>Light colour options</b>	RGB (64,000 Whites + 16 Million Colours) Tunable White
<b>Colour temperature</b>	3000K - 5700K + RGB
<b>Beam angle</b>	120°
<b>IP Rating</b>	IP54

\*Via the App or voice control. For additional information please visit our website

### Product range

Code	Description
<b>AT3013/16/WiZ/TR</b> SKU: 15117	16W 350mm Opal acrylic LED Oyster - WiZ Connected Pro - Colours + Adjustable White - 1560 - 1590lm
<b>AT3013/16/WiZ/TW</b> SKU: 15102	16W 350mm Opal acrylic LED Oyster - WiZ Connected Pro - Adjustable White - 1585 - 1595lm



> 64,000 WHITES > 16 MILLION COLOURS

### WiZ Pro Enterprise lighting interface

#### SET THE RULES AND SUPERVISE

Control multiple rooms and floors, pre-program schedules and set scenes

#### ENERGY USAGE MONITORING

Reports can be generated and exported based on each lamp's usage and energy consumption

#### PREDICTIVE MAINTENANCE

Each light reports its usage to the cloud. Lifespan can be calculated to proactively identify and replace fading lights

### Finish

White

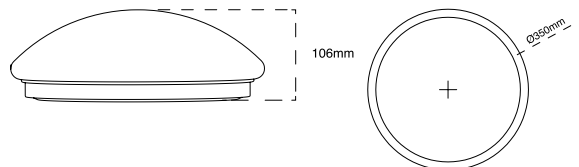

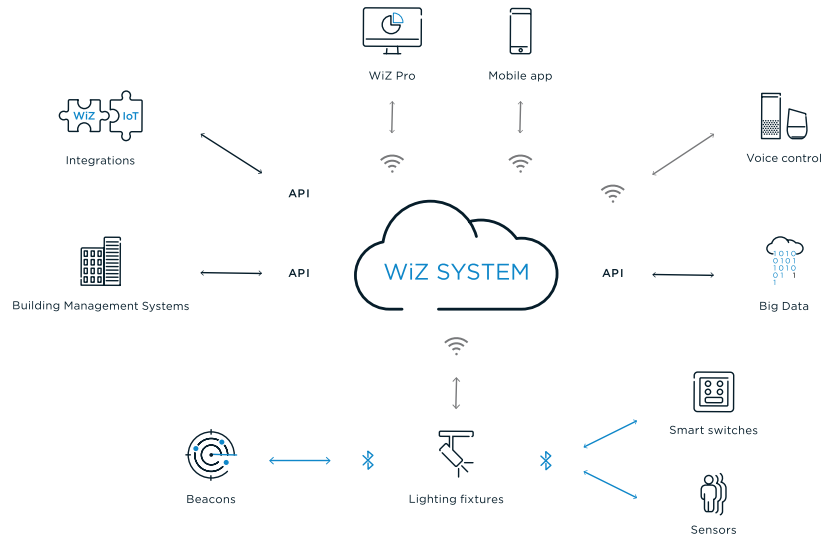

## AT3017/WiZ

16W 300mm Opal acrylic LED Oyster WiZ Connected Pro

### Product specification

<b>Voltage</b>	230~50Hz
<b>Power consumption</b>	16W
<b>Dimmable</b>	Yes*
<b>Light colour options</b>	RGB (64,000 Whites + 16 Million Colours) Tunable White
<b>Colour temperature</b>	3000K - 5700K + RGB
<b>Beam angle</b>	120°
<b>IP Rating</b>	IP20

\*Via the App or voice control. For additional information please visit our website

### Product range

Code	Description
<b>AT3017/16/WiZ/TR</b> SKU: 15180	16W 300mm Opal acrylic LED Oyster - WiZ Connected Pro - Colours + Adjustable White - 1435 - 1500lm
<b>AT3017/16/WiZ/TW</b> SKU: 15195	16W 300mm Opal acrylic LED Oyster - WiZ Connected Pro - Adjustable White - 1450 - 1570lm

> 64,000 WHITES > 16 MILLION COLOURS

### WiZ Pro Enterprise lighting interface

#### SET THE RULES AND SUPERVISE

Control multiple rooms and floors, pre-program schedules and set scenes

#### ENERGY USAGE MONITORING

Reports can be generated and exported based on each lamp's usage and energy consumption

#### PREDICTIVE MAINTENANCE

Each light reports its usage to the cloud. Lifespan can be calculated to proactively identify and replace fading lights

### Finish

White

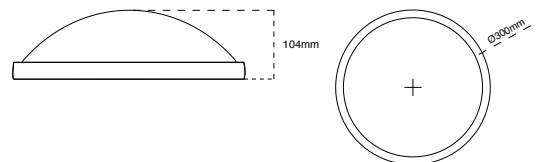



## AT3013/13/TRI

13W 260mm Opal Acrylic LED Oyster- Tri Colour

### Product specification

<b>Voltage</b>	230~50Hz
<b>Power consumption</b>	13W
<b>Dimmable</b>	No
<b>Light colour options</b>	Tri Colour 
<b>Colour temperature</b>	3000K, 4000K & 5000K
<b>Beam angle</b>	120°
<b>IP Rating</b>	IP20

### Product range

Code	Description
AT3013/13/TRI SKU: 12846	13W 260mm Opal Acrylic LED Oyster - Tri Colour - 900 - 1080lm



### Finish

White

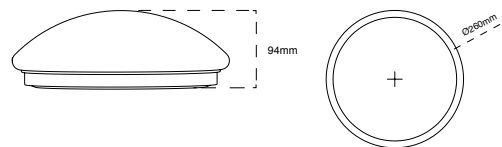



## AT3013/16/TRI

16W 330mm Opal Acrylic LED Oyster- Tri Colour

### Product specification

<b>Voltage</b>	230~50Hz
<b>Power consumption</b>	16W
<b>Dimmable</b>	No
<b>Light colour options</b>	Tri Colour 
<b>Colour temperature</b>	3000K, 4000K & 5000K
<b>Beam angle</b>	120°
<b>IP Rating</b>	IP20

### Product range

Code	Description
AT3013/16/TRI SKU: 11886	16W 330mm Opal Acrylic LED Oyster - Tri Colour - 1100 - 1280lm



### Finish

White

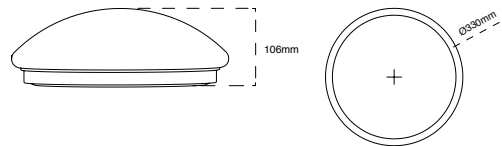



3 Step Dimming Function

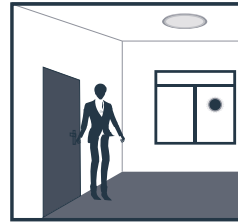

With sufficient ambient light, the sensor does not switch on the lamp



With insufficient ambient light, the sensor switches on the lamp when motion is detected



After hold time, the sensor dims the lamp at a low light level if no new motion trigger

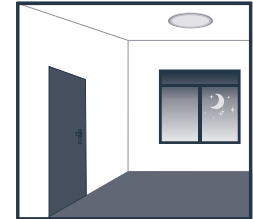

After stand - by period, the sensor switches off the lamp if no motion is detected in its detection zone



AT3013/16/TRI/CF

16W 330mm LED Opal Acrylic Oyster - Tri Colour with sensor and corridor function

Product specification

Voltage	230~50Hz
Power consumption	16W
Dimmable	Yes*
Light colour options	Tri Colour
Colour temperature	3000K, 4000K & 5000K
Beam angle	120°
IP Rating	IP20
Detection range	4m (at 3m mounting height)

Product range

Code	Description
AT3013/16/TRI/CF SKU: 14053	16W LED Opal Acrylic Oyster 330mm - Tri Colour with sensor and corridor function - 1330 - 1530lm



Sensor functions

ON - OFF FUNCTION

With insufficient ambient light, the sensor switches on the lamp when motion is detected

3 STEP DIMMING FUNCTION

When there is insufficient light the sensor switches on the lamp when motion is detected. After hold time, the sensor dims the lamp at a low light level if no new motion trigger. After a stand - by period, the sensor switches off the lamps if no motion is detected in its detection zone

SETTING SENSOR

By selecting the combination on the DIP switch, sensor data can be precisely set for each specific application

Finish

White

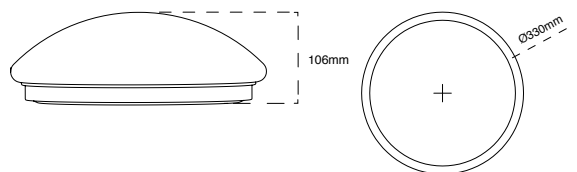



## AT3013/26/TRI

26W 380mm Opal Acrylic LED Oyster - Tri Colour

### Product specification

<b>Voltage</b>	230~50Hz
<b>Power consumption</b>	26W
<b>Dimmable</b>	No
<b>Light colour options</b>	Tri Colour 
<b>Colour temperature</b>	3000K, 4000K & 5000K
<b>Beam angle</b>	120°
<b>IP Rating</b>	IP20

### Product range

Code	Description
AT3013/26/TRI SKU: 11493	26W 380mm Opal Acrylic LED Oyster - Tri Colour - 1140 - 1260lm



### Finish

White

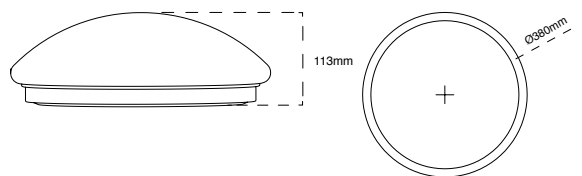



## AT3013/26/TRI/CF

26W 380mm LED Opal Acrylic Oyster - Tri Colour with sensor and corridor function

### Product specification

<b>Voltage</b>	230~50Hz
<b>Power consumption</b>	26W
<b>Dimmable</b>	No
<b>Light colour options</b>	Tri Colour
<b>Colour temperature</b>	3000K, 4000K & 5000K
<b>Beam angle</b>	120°
<b>IP Rating</b>	IP20
<b>Detection range</b>	4m (at 3m mounting height)

### Product range

Code	Description
AT3013/26/TRI/CF SKU: 14127	26W LED Opal Acrylic Oyster 380mm - TRI Colour with sensor and corridor function - 2260 - 2815lm

### 3 Step Dimming Function

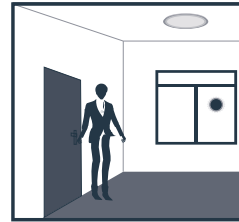

With sufficient ambient light, the sensor does not switch on the lamp



With insufficient ambient light, the sensor switches on the lamp when motion is detected



After hold time, the sensor dims the lamp at a low light level if no new motion trigger

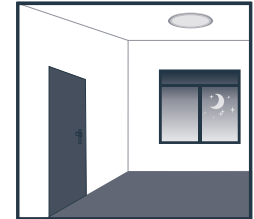

After stand - by period, the sensor switches off the lamp if no motion is detected in its detection zone



### Sensor functions

#### ON - OFF FUNCTION

With insufficient ambient light, the sensor switches on the lamp when motion is detected

#### 3 STEP DIMMING FUNCTION

When there is insufficient light the sensor switches on the lamp when motion is detected. After hold time, the sensor dims the lamp at a low light level if no new motion trigger. After a stand - by period, the sensor switches off the lamps if no motion is detected in its detection zone

#### SETTING SENSOR

By selecting the combination on the DIP switch, sensor data can be precisely set for each specific application

### Finish

White

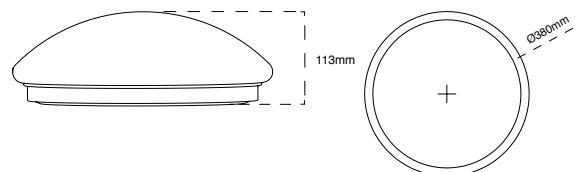



## AT3014/12

12W 250mm LED Round Low Profile Dimmable IP54 Polycarbonate Oyster



**Finish**

White

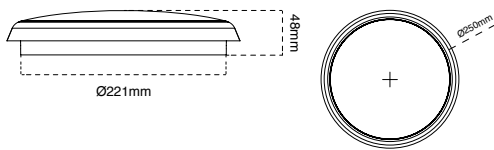

**Product specification**

<b>Voltage</b>	230~50Hz
<b>Power consumption</b>	12W
<b>Dimmable</b>	Yes
<b>Light colour options</b>	Warm white & Cool white
<b>Colour temperature</b>	3000 & 4000K
<b>Beam angle</b>	120°
<b>IP Rating</b>	IP54

**Product range**

Code	Description
<b>AT3014/12/LED/WH/WW</b> SKU: 11029	250mm 12W LED Round Low Profile Dimmable IP54 Polycarbonate Oyster - White Trim - 3000K - Warm white - 1190lm
<b>AT3014/12/LED/WH/CW</b> SKU: 10924	250mm 12W LED Round Low Profile Dimmable IP54 Polycarbonate Oyster - White Trim - 4000K - Cool white - 1280lm



**Finish**

White

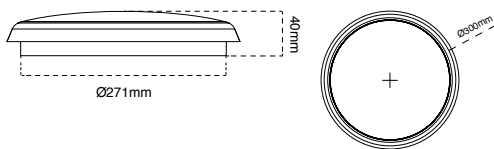

## AT3014/18

18W 300mm LED Round Low Profile Dimmable IP54 Polycarbonate Oyster

**Product specification**

<b>Voltage</b>	230~50Hz
<b>Power consumption</b>	18W
<b>Dimmable</b>	Yes
<b>Light colour options</b>	Warm white & Cool white
<b>Colour temperature</b>	3000 & 4000K
<b>Beam angle</b>	120°
<b>IP Rating</b>	IP54

**Product range**

Code	Description
<b>AT3014/18/LED/WH/WW</b> SKU: 11042	300mm 18W LED Round Low Profile Dimmable Polycarbonate Oyster - White Trim - 3000K - Warm white - 1745lm
<b>AT3014/18/LED/WH/CW</b> SKU: 10933	300mm 18W LED Round Low Profile Dimmable Polycarbonate Oyster - White Trim - 4000K - Cool white - 1800lm



**Finish**

White

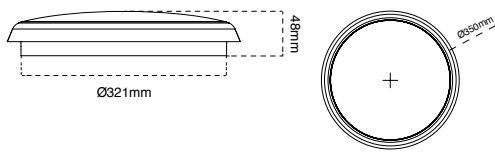

**Finish**

White

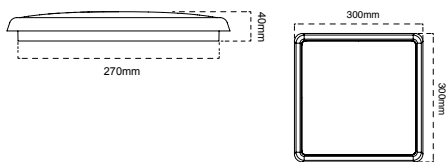

## AT3014/25

25W 350mm LED Round Low Profile Dimmable IP54 Polycarbonate Oyster

**Product specification**

<b>Voltage</b>	230~50Hz
<b>Power consumption</b>	25W
<b>Dimmable</b>	Yes
<b>Light colour options</b>	Warm white & Cool white
<b>Colour temperature</b>	3000 & 4000K
<b>Beam angle</b>	120°
<b>IP Rating</b>	IP54

**Product range**

Code	Description
AT3014/25/LED/WH/WW SKU: 11032	350mm 25W LED Round Low Profile Dimmable IP54 Polycarbonate Oyster - White Trim - 3000K - Warm white - 2355lm
AT3014/25/LED/WH/CW SKU: 10928	350mm 25W LED Round Low Profile Dimmable IP54 Polycarbonate Oyster - White Trim - 4000K - Cool white - 2545lm

## AT3015/18

18W 300mm LED Square Low Profile Dimmable IP54 Polycarbonate Oyster

**Product specification**

<b>Voltage</b>	230~50Hz
<b>Power consumption</b>	18W
<b>Dimmable</b>	Yes
<b>Light colour options</b>	Cool white
<b>Colour temperature</b>	4000K
<b>Beam angle</b>	120°
<b>IP Rating</b>	IP54

**Product range**

Code	Description
AT3015/18/LED/WH/CW SKU: 10912	300mm 18W LED Square Low Profile Dimmable IP54 Polycarbonate Oyster - White Trim - 4000K - Cool white - 2000lm

## DIFFUSERS



### **AT3013/13/TRI/DIFF**

SKU 10083

13W 260mm Opal Acrylic LED Oyster - Tri Colour Diffuser Only.

Suitable for *AT3013/13*



### **AT3013/16/TRI/DIFF**

SKU 10094

16W 330mm Opal Acrylic LED Oyster - Tri Colour Diffuser Only.

Suitable for *AT3013/16*



### **AT3013/26/TRI/DIFF**

SKU 10488

26W 380mm Opal Acrylic LED Oyster - Tri Colour Diffuser Only.

Suitable for *AT3013/26*



## LED Strips

LED Strip lighting can illuminate areas that are normally dark and allow features to be made underneath cabinets and stairs.



# Overview

## LED STRIPS

LED STRIPS KITS	59
SHALLOW EXTRUSIONS KITS	60
DEEP EXTRUSIONS KITS	60
CORNER EXTRUSIONS KITS	61
ACCESSORIES	61







## AT9208/KIT

5m LED Strip Kit (150PC)

### Product specification

<b>Voltage</b>	230~50Hz
<b>Power consumption</b>	5W (per metre)
<b>Dimmable</b>	No
<b>Light colour options</b>	Warm white, Daylight & RGB
<b>Colour temperature</b>	2000K, 4000K & RGB
<b>IP Rating</b>	IP65
<b>Length</b>	5m

### Product range

Code	Description
<b>AT9208WW/KIT</b> SKU: 10442	5m LED Strip Kit (150 PC) - 3000K - Warm white - 2000lm
<b>AT9208DL/KIT</b> SKU: 10678	5m LED Strip Kit (150PC) - 5000K - Daylight - 2000lm
<b>AT9208RGB/KIT</b> SKU: 10806	5m LED Strip Kit (150 PC) - RGB - comes with controller



**Finish**

Anodised aluminium

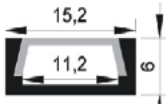

**Finish**

Anodised aluminium

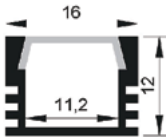

**Finish**

Anodised aluminium

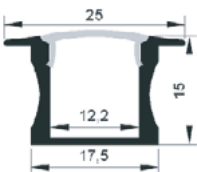

## AT9220

Square Shallow Extrusion Kit

**Product range**

Code	Description
AT9220/1M SKU: 11688	Square Shallow Extrusion KIT - 1M
AT9220/2M SKU: 11735	Square Shallow Extrusion KIT - 2M

## AT9221

Square Deep Extrusion Kit

**Product range**

Code	Description
AT9221/2M SKU: 12057	Square Deep Extrusion KIT - 2M

## AT9228

Square Deep Recessed Extrusion Kit

**Product range**

Code	Description
AT9228/2M SKU: 10520	Square Deep Recessed Extrusion KIT - 2M

# atom

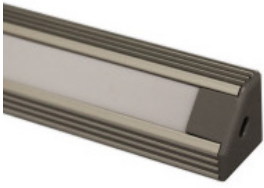

### Finish

■ Anodised aluminium

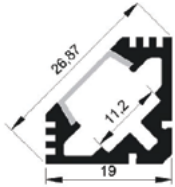

## CONNECTOR



### AT9213

SKU 10013

Connector - directly to single colour strips  
'Non Waterproof' with 500mm leads

## AT9227

Triangular Corner Extrusion Kit

### Product range

Code	Description
AT9227/2M SKU: 12359	Triangular Corner Extrusion KIT - 2M



## LED Step Lights

Install wall lights to keep staircases and corridors illuminated so that everyone in the residence is safe at all times of the day and night.

# Overview

## LED STEP LIGHTS

SQUARE OPAL RECESSED STEP LIGHT	64
SQUARE CLEAR RECESSED STEP LIGHT	64
RECTANGULAR OPAL RECESSED STEP LIGHT	65
RECTANGULAR CLEAR RECESSED STEP LIGHT	65



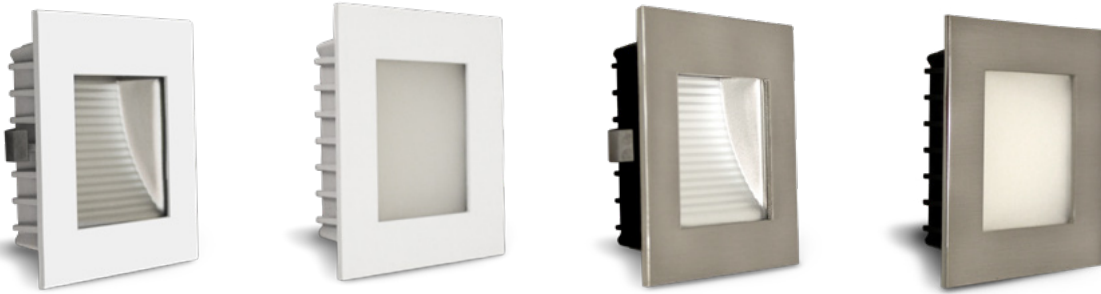

## AT9500

2W LED Square 70 x 70mm Recessed Step Light with Driver

### Product specification

<b>Voltage</b>	230~50Hz
<b>Power consumption</b>	2W
<b>Dimmable</b>	No
<b>Light colour options</b>	Warm white & Cool white
<b>Colour temperature</b>	3000 & 4000K
<b>Beam angle</b>	100°
<b>IP Rating</b>	IP44 (Front face only)
<b>IC Rating</b>	IC - 4

### Product range

Code	Description
<b>AT9500/SC/WW/C</b> SKU: 10753	2W LED Square Recessed Step Light with Driver - Satin chrome - Clear Lens - 3000K - Warm white - 95lm
<b>AT9500/SC/WW/O</b> SKU: 10518	2W LED Square Recessed Step Light with Driver - Satin chrome - Opal Lens - 3000K - Warm white - 95lm
<b>AT9500/SC/CW/C</b> SKU: 10635	2W LED Square Recessed Step Light with Driver - Satin chrome - Clear Lens - 4000K - Cool white - 105lm
<b>AT9500/SC/CW/O</b> SKU: 10282	2W LED Square Recessed Step Light with Driver - Satin chrome - Opal Lens - 4000K - Cool white - 105lm
<b>AT9500/WH/WW/C</b> SKU: 10636	2W LED Square Recessed Step Light with Driver - White - Clear Lens - 3000K - Warm white - 95lm
<b>AT9500/WH/WW/O</b> SKU: 10283	2W LED Square Recessed Step Light with Driver - White - Opal Lens - 3000K - Warm white - 95lm
<b>AT9500/WH/CW/C</b> SKU: 10400	2W LED Square Recessed Step Light with Driver - White - Clear Lens - 4000K - Cool white - 105lm
<b>AT9500/WH/CW/O</b> SKU: 10754	2W LED Square Recessed Step Light with Driver - White - Opal Lens - 4000K - Cool white - 105lm

### Finish

□ White    ■ Satin chrome

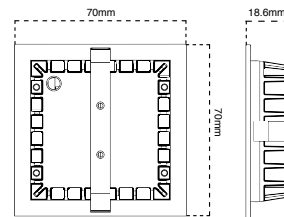

**CUT-OUT:** 62mm x 62mm





## AT9501

3W LED Rectangular 110 x 70mm Recessed Step Light with Driver

### Product specification

<b>Voltage</b>	230~50Hz
<b>Power consumption</b>	3W
<b>Dimmable</b>	No
<b>Light colour options</b>	Warm white & Cool white
<b>Colour temperature</b>	3000 & 4000K
<b>Beam angle</b>	100°
<b>IP Rating</b>	IP44 (Front face only)
<b>IC Rating</b>	IC - 4

### Product range

Code	Description
<b>AT9501/WH/WW/C</b> SKU: 10524	3W LED Rectangular Recessed Step Light with Driver - White - Clear Lens - 3000K - Warm white - 185lm
<b>AT9501/WH/WW/O</b> SKU: 10642	3W LED Rectangular Recessed Step Light with Driver - White - Opal Lens - 3000K - Warm white - 185lm
<b>AT9501/WH/CW/C</b> SKU: 10288	3W LED Rectangular Recessed Step Light with Driver - White - Clear Lens - 4000K - Cool white - 190lm
<b>AT9501/WH/CW/O</b> SKU: 10406	3W LED Rectangular Recessed Step Light with Driver - White - Opal Lens - 4000K - Cool white - 190lm

### Finish

White

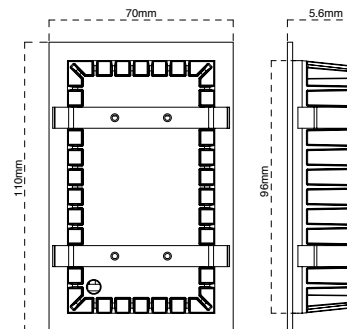

**CUT-OUT:** 100mm x 60mm



## LED Bunkers

Illuminate dark external areas with LED Bunker lights, they look great in pool areas and walkways.

# Overview

## LED BUNKERS

CORRIDOR FUNCTION LED BUNKERS	68
TRI COLOUR LED BUNKERS	69 - 70
LED BUNKERS OVAL	71
LED BUNKERS ROUND	72
LED BUNKERS RECTANGLE	73





3 Step Dimming Function

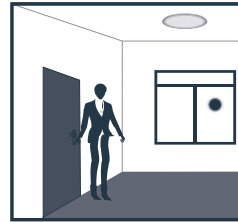

With sufficient ambient light, the sensor does not switch on the lamp



With insufficient ambient light, the sensor switches on the lamp when motion is detected



After hold time, the sensor dims the lamp at a low light level if no new motion trigger

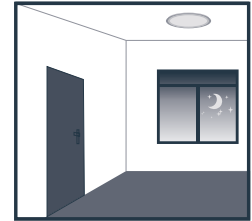

After stand - by period, the sensor switches off the lamp if no motion is detected in its detection zone

AT5812/TRI/CF

27W/17W LED Square Polycarbonate Bulkhead IP65 - with selectable power consumption and corridor function

Product specification

Voltage	230~50Hz
Power consumption	17W & 27W
Dimmable	No
Light colour options	Tri Colour
Colour temperature	3000K, 4000K & 5000K
Beam angle	120°
IP Rating	IP65
IK Rating	IK08
Detection range	7m (at 2m mounting height)

Product range

Code	Description
AT5812/TRI/CF SKU:12209	27W/17W LED Square Polycarbonate Bulkhead IP65 - with sensor and corridor function - 1355 - 1440lm (17W) - 2575 - 2825lm (27W)



Corridor function

SENSOR

Adjust sensor sensitivity according to location, the detection distance of low sensitivity could be only 2m and high sensitivity could be up to 16m for a larger room

TIME

The time that the luminaire stays on at full power once motion is detected. The minimum time is 10sec±3sec, the maximum is 12min±1min. (The luminaire will stay on while the sensor detects movement)

LUX

The amount of ambient light at which the luminaire will switch on the lights if movement is detected. When set to the 'sun' position (max) the luminaire will work in both daytime and night. When set to the '3' position (min) the luminaire will only work when the ambient light is 3LUX (twilight)

Finish

Grey

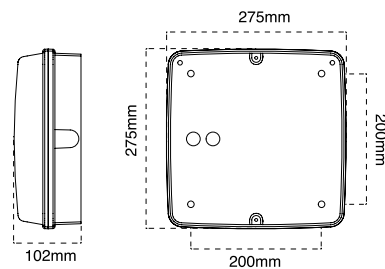



## AT5709/TRI/CF

LED Large 14W Polycarbonate Bulkhead with corridor function - Tri Colour

### Product specification

<b>Voltage</b>	230~50Hz
<b>Power consumption</b>	14W
<b>Dimmable</b>	No
<b>Light colour options</b>	Tri Colour 
<b>Colour temperature</b>	3000K - 5000K
<b>Lumen output</b>	1270 - 1390lm
<b>Beam angle</b>	120°
<b>IP Rating</b>	IP65
<b>Detection range</b>	4m (at 3m mounting height)

### Product range

Code	Description
AT5709/WH/TRI/CF SKU: 16066	LED Large 14W Polycarbonate Bunker with corridor function - White - Tri Colour
AT5709/BLK/TRI/CF SKU: 16038	LED Large 14W Polycarbonate Bunker with corridor function - Black - Tri Colour

### Sensor functions

#### ON - OFF FUNCTION

With insufficient ambient light, the sensor switches on the lamp when motion is detected

#### 3 STEP DIMMING FUNCTION

When there is insufficient light the sensor switches on the lamp when motion is detected. After hold time, the sensor dims the lamp at a low light level if no new motion trigger. After a stand - by period, the sensor switches off the lamps if no motion is detected in its detection zone

#### SETTING SENSOR

By selecting the combination on the DIP switch, sensor data can be precisely set for each specific application

### Finish

 White  Black

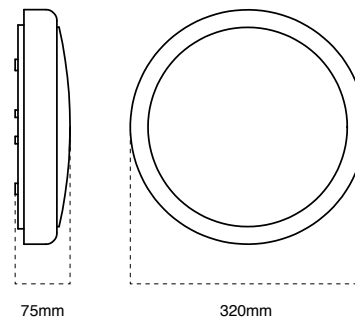



## AT5709/TRI

LED Large 14W Polycarbonate Bulkhead - Tri Colour

### Product specification

<b>Voltage</b>	230~50Hz
<b>Power consumption</b>	14W
<b>Dimmable</b>	No
<b>Light colour options</b>	Tri - colour
<b>Colour temperature</b>	3000 - 5000K
<b>Lumen output</b>	1280 - 1390lm
<b>Beam angle</b>	120°
<b>IP Rating</b>	IP65

### Product range

Code	Description
<b>AT5709/WH/TRI</b> SKU: 16051	LED Large 14W Polycarbonate Bunker - White - Tri Colour
<b>AT5709/BLK/TRI</b> SKU: 16020	LED Large 14W Polycarbonate Bunker - Black - Tri Colour

### Finish

White
  Black

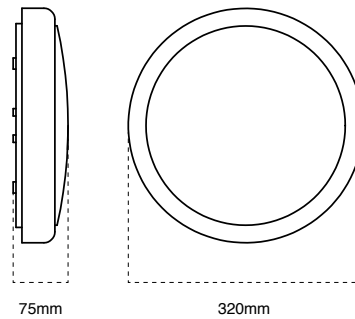



## AT3016/OH

Oval 12W LED Polycarbonate Bulkhead - with Eyelid option

### Product specification

<b>Voltage</b>	230~50Hz
<b>Power consumption</b>	12W
<b>Light colour options</b>	Cool white
<b>Colour temperature</b>	4000K
<b>Dimmable</b>	No
<b>Beam angle</b>	120°
<b>IP Rating</b>	IP66
<b>IK Rating</b>	IK10

### Product range

Code	Description
<b>AT3016/WH/OH/CW</b> SKU: 11188	Oval 12W LED Polycarbonate Bunker - with Eyelid option - White - 860lm (600lm with eyelid)
<b>AT3016/BLK/OH/CW</b> SKU: 11132	Oval 12W LED Polycarbonate Bunker - with Eyelid option - Black - 860lm (520lm with eyelid)



### Finish

White
  Black

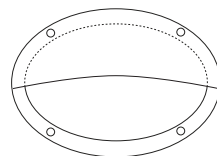
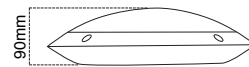
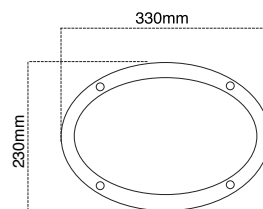

(with eyelid option fitted)



## AT3016/RD

Round 12W LED Polycarbonate Bulkhead - with Eyelid option

### Product specification

<b>Voltage</b>	230~50Hz
<b>Power consumption</b>	12W
<b>Light colour options</b>	Cool white
<b>Colour temperature</b>	4000K
<b>Dimmable</b>	No
<b>Beam angle</b>	120°
<b>IP Rating</b>	IP66
<b>IK Rating</b>	IK10

### Product range

Code	Description
AT3016/WH/RD/CW SKU: 11171	Round 12W LED Polycarbonate Bunker - with Eyelid option - White - 930lm (665lm with eyelid)
AT3016/BLK/RD/CW SKU: 11179	Round 12W LED Polycarbonate Bunker - with Eyelid option - Black - 900lm (930lm with eyelid)



### Finish

White
  Black

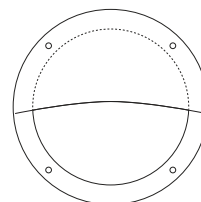
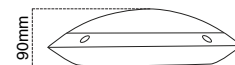
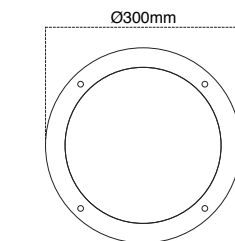

(With eyelid option fitted)





## AT5832

12W LED Rectangle Polycarbonate Bulkhead - IP65 with Wall Washer option

### Product specification

<b>Voltage</b>	230~50Hz
<b>Power consumption</b>	12W
<b>Light colour options</b>	Cool white
<b>Colour temperature</b>	4000K
<b>Dimmable</b>	No
<b>Beam angle</b>	120°
<b>IP Rating</b>	IP65

### Product range

Code	Description
<b>AT5832/WH</b> SKU: 10419	12W LED Rectangle Polycarbonate Bulkhead - IP65 with wall washer option - White - Cool White - 980lm
<b>AT5832/BLK</b> SKU: 10269	12W LED Rectangle Polycarbonate Bulkhead - IP65 with wall washer option - Black - Cool White - 980lm

\*Lumens measured with plain cover.

### Finish

White Black

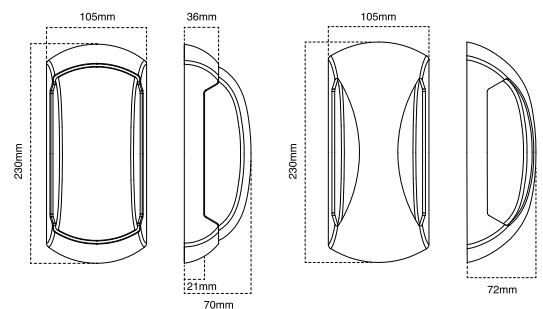

(with wall cover option attached)



## LED Lamps

Light up your living space with our extensive Atom LED lamps range. From traditional to smart lighting, we have the right lamp to suit your needs.

# Overview

## LED LAMPS

WIZ CONNECTED PRO	77 - 79
LED GLS LAMPS	80 - 81
LED CANDLE LAMPS	82 - 83
LED STICK LAMPS	83
LED G95 LAMPS	84
LED G120 LAMPS	85
LED G45 LAMPS	86
LED R63/R80 LAMPS	87
LED GU10 LAMPS	88
LED MR16 LAMPS	89
LED ST64 LAMPS	90 - 91
LED PAR38 LAMPS	92
LED LAMPS WITH DRIVER	92
ACCESSORIES	93







## AT9424/WIZ/TR, AT9429/WIZ/TR, AT9426/WIZ/TR & AT9430/WIZ/TR

WiZ Colours + Adjustable White WiFi Lamps

### Product specification

<b>Voltage</b>	230~50Hz
<b>Power consumption</b>	6.6W, 7.5W, 11.5W & 15.5W
<b>Light colour options</b>	Tri Colour (3000K, 4000K & 6500K) + RGB
<b>Lamp shape</b>	A60, G100, E14 & GU10
<b>Dimmable</b>	Yes*
<b>Beam angle</b>	240°
<b>Colour rendering index</b>	80
<b>Average rated life</b>	L70 (6k) 25,000 hours
<b>Switching cycles</b>	≥50,000 cycles

\*Via the App or voice control. For additional information please visit [www.atomlighting.com.au](http://www.atomlighting.com.au)

### Product range

Code	Description
<b>AT9424/WIZ/A60/TR</b> SKU: 17718	11.5W A60 WiZ Connected Pro Colours + Adjustable White WiFi Lamp - ES/E27 - 806lm
<b>AT9424/WIZ/A60/TR/2PK</b> SKU: 17736	Twin pack 11.5W A60 WiZ Connected Pro Colours + Adjustable White WiFi Lamp - ES/E27 - 806lm
<b>AT9424/WIZ/G100/TR</b> SKU: 17802	15.5W G100 WiZ Connected Pro - ES/E27 - 1055lm
<b>AT9429/WIZ/A60/TR</b> SKU: 17532	11.5W A60 WiZ Connected Pro - BC/B22 - 806lm
<b>AT9429/WIZ/A60/TR/2PK</b> SKU: 17844	Twin pack 11.5W A60 WiZ Connected Pro Tunable White Lamp - Warm White - BC/B22 - 806lm
<b>AT9426/WIZ/E14/TR</b> SKU: 17934	7.5W E14 WiZ Connected Pro - E14 - 470lm
<b>AT9430/WIZ/GU10/TR</b> SKU: 17948	Twin pack 6.6W GU10 WiZ Connected Pro - GU10 - 360lm

> 64,000 WHITES > 16 MILLION COLOURS

### WiZ Pro Enterprise lighting interface

#### SET THE RULES AND SUPERVISE

Control multiple rooms and floors, pre-program schedules and set scenes

#### ENERGY USAGE MONITORING

Reports can be generated and exported based on each lamp's usage and energy consumption

#### PREDICTIVE MAINTENANCE

Each light reports its usage to the cloud. Lifespan can be calculated to proactively identify and replace fading lights

### Finish

White

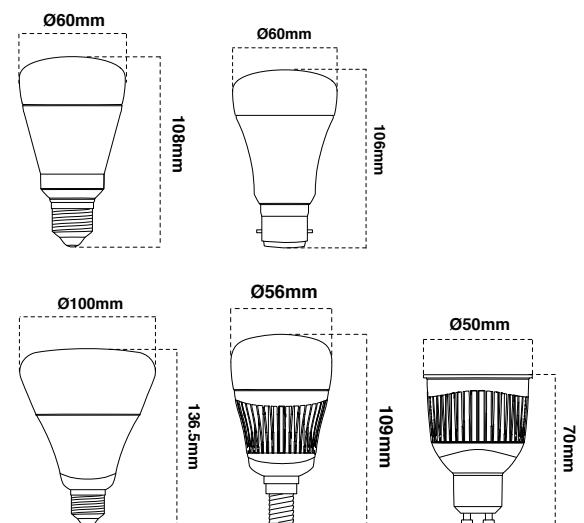

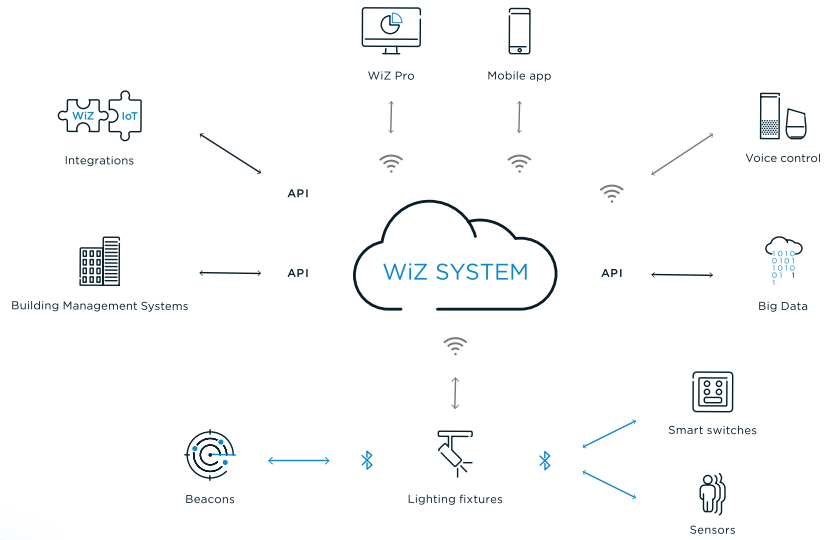

## AT9424/WIZ/G100

13W WiZ Tunable White Lamp

### Product specification

<b>Voltage</b>	230~50Hz
<b>Power consumption</b>	13W
<b>Light colour options</b>	Warm white & Daylight
<b>Lamp shape</b>	G100
<b>Dimmable</b>	Yes*
<b>Beam angle</b>	240°
<b>Colour rendering index</b>	80
<b>Average rated life</b>	L70 (6k) 25,000 hours
<b>Switching cycles</b>	≥50,000 cycles

\*Via the App or voice control. For additional information please visit [www.atomlighting.com.au](http://www.atomlighting.com.au)

### Product range

Code	Description
AT9424/WIZ/G100/WW SKU: 17671	13W G100 LED Dimmable WiZ Connected Pro Tunable White Lamp - Warm White - ES/E27 - 1055lm
AT9424/WIZ/G100/DL SKU: 17692	13W G100 LED Dimmable - WiZ Connected Pro Tunable White Lamp - Daylight - ES/E27 - 1055lm

> 64,000 WHITES

### WiZ Pro Enterprise lighting interface

#### SET THE RULES AND SUPERVISE

Control multiple rooms and floors, pre-program schedules and set scenes

#### ENERGY USAGE MONITORING

Reports can be generated and exported based on each lamp's usage and energy consumption

#### PREDICTIVE MAINTENANCE

Each light reports its usage to the cloud. Lifespan can be calculated to proactively identify and replace fading lights

### Finish

White

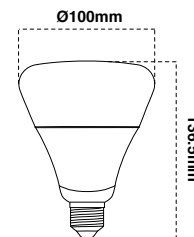



## AT9424/WiZ & AT9429/WiZ

10W WiZ Tunable White Lamp

### Product specification

<b>Voltage</b>	230~50Hz
<b>Power consumption</b>	10W
<b>Light colour options</b>	Warm white & Daylight
<b>Lumen output</b>	806lm
<b>Lamp shape</b>	A60
<b>Dimmable</b>	Yes*
<b>Beam angle</b>	240°
<b>Colour rendering index</b>	80
<b>Average rated life</b>	L70 (6k) 25,000 hours
<b>Switching cycles</b>	≥50,000 cycles

\*Via the App or voice control. For additional information please visit [www.atomlighting.com.au](http://www.atomlighting.com.au)

### Product range

Code	Description
<b>AT9424/WiZ/A60/WW</b> SKU: 17555	10W A60 LED Dimmable - WiZ Connected Pro Tunable White Lamp - Warm White - ES/E27 - 806lm
<b>AT9424/WiZ/A60/WW/2PK</b> SKU: 17549	(2x) 10W A60 LED Dimmable - WiZ Connected Pro Tunable White Lamp - Warm White - ES/E27 - 806lm
<b>AT9424/WiZ/A60/DL</b> SKU: 17524	10W A60 LED Dimmable - WiZ Connected Pro Tunable White Lamp - Daylight - ES/E27 - 806lm
<b>AT9424/WiZ/A60/DL/2PK</b> SKU: 17511	(2x) 10W A60 LED Dimmable - WiZ Connected Pro Tunable White Lamp - Daylight - ES/E27 - 806lm
<b>AT9429/WiZ/A60/WW</b> SKU: 17865	10W A60 LED Dimmable - WiZ Connected Pro Tunable White Lamp - Warm White - BC/B22 - 806lm
<b>AT9429/WiZ/A60/WW/2PK</b> SKU: 17870	(2x) 10W A60 LED Dimmable - WiZ Connected Pro Tunable White Lamp - Warm White - BC/B22 - 806lm
<b>AT9429/WiZ/A60/DL</b> SKU: 17888	10W A60 LED Dimmable - WiZ Connected Pro Tunable White Lamp - Daylight - BC/B22 - 806lm
<b>AT9429/WiZ/A60/DL/2PK</b> SKU: 17911	(2x) 10W A60 LED Dimmable - WiZ Connected Pro Tunable White Lamp - Daylight - BC/B22 - 806lm

> 64,000 WHITES

### WiZ Pro Enterprise lighting interface

#### SET THE RULES AND SUPERVISE

Control multiple rooms and floors, pre-program schedules and set scenes

#### ENERGY USAGE MONITORING

Reports can be generated and exported based on each lamp's usage and energy consumption

#### PREDICTIVE MAINTENANCE

Each light reports its usage to the cloud. Lifespan can be calculated to proactively identify and replace fading lights

### Finish

White

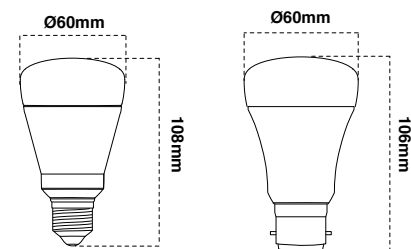

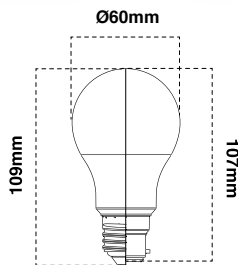
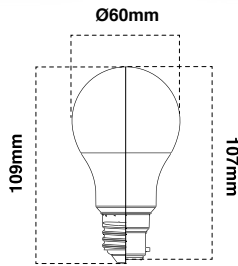

## AT9423

9.4W Non - Dimmable GLS LED Lamp - Frosted

### Product specification

<b>Voltage</b>	230~50Hz
<b>Power consumption</b>	9.4W
<b>Lamp shape</b>	A60
<b>Dimmable</b>	No
<b>Beam angle</b>	240°
<b>Colour rendering index</b>	80
<b>Average rated life</b>	15,000 hours
<b>Switching cycles</b>	≥50,000 cycles

### Product range

Code	Description
<b>AT9423/ES/WW</b> SKU: 16630	9.4W Non - Dimmable GLS Lamp - Warm white 3000K ES/E27 Frosted - 806lm
<b>AT9423/ES/CW</b> SKU: 10737	9.4W Non - Dimmable GLS Lamp - Cool white 4000K ES/E27 Frosted - 840lm
<b>AT9423/ES/DL</b> SKU: 16238	9.4W Non - Dimmable GLS Lamp - Daylight 6500K ES/E27 Frosted - 840l
<b>AT9423/BC/WW</b> SKU: 17335	9.4W Non - Dimmable GLS Lamp - Warm white 3000K BC/B22 Frosted - 806lm
<b>AT9423/BC/CW</b> SKU: 16116	9.4W Non - Dimmable GLS Lamp - Cool white 4000K BC/B22 Frosted - 840lm
<b>AT9423/BC/DL</b> SKU: 16074	9.4W Non - Dimmable GLS Lamp - Daylight 6500K BC/B22 Frosted - 840l

## AT9424

9.8W Dimmable GLS LED Lamp - Frosted

### Product specification

<b>Voltage</b>	230~50Hz
<b>Power consumption</b>	9.8W
<b>Lamp shape</b>	A60
<b>Dimmable</b>	Yes
<b>Beam angle</b>	240°
<b>Colour rendering index</b>	80
<b>Average rated life</b>	15,000 hours
<b>Switching cycles</b>	≥50,000 cycles

### Product range

Code	Description
<b>AT9424/ES/WW</b> SKU: 18895	9.8W Dimmable GLS Lamp - Warm White 3000K ES/E27 Frosted - 806lm
<b>AT9424/ES/CW</b> SKU: 17710	9.8W Dimmable GLS Lamp - Cool White 4000K ES/E27 Frosted - 840lm
<b>AT9424/ES/DL</b> SKU: 15904	9.8W Dimmable GLS Lamp - Daylight 6500K ES/E27 Frosted - 840l
<b>AT9424/BC/WW</b> SKU: 18274	9.8W Dimmable GLS Lamp - Warm White 3000K BC/B22 Frosted - 806lm
<b>AT9424/BC/CW</b> SKU: 16828	9.8W Dimmable GLS Lamp - Cool White 4000K BC/B22 Frosted - 840lm
<b>AT9424/BC/DL</b> SKU: 16595	9.8W Dimmable GLS Lamp - Daylight 6500K BC/B22 Frosted - 840l



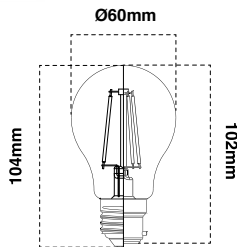
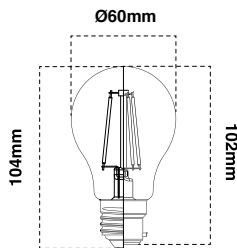

## AT9474

8.3W Dimmable GLS Filament Lamp - Clear

### Product specification

<b>Voltage</b>	230~50Hz
<b>Power consumption</b>	8.3W
<b>Lamp shape</b>	A60
<b>Dimmable</b>	Yes
<b>Beam angle</b>	360°
<b>Colour rendering index</b>	80
<b>Average rated life</b>	15,000 hours
<b>Switching cycles</b>	≥50,000 cycles

### Product range

Code	Description
AT9474/ES/WW/C SKU: 11152	A60 Filament 8.3W Dimmable - Warm white 2700K ES/E27 Clear - 806lm
AT9474/BC/WW/C SKU: 12623	A60 Filament 8.3W Dimmable Warm white 2700K BC/B22 Clear - 806lm

## AT9476

5.1W Dimmable GLS Filament Lamp - Clear

### Product specification

<b>Voltage</b>	230~50Hz
<b>Power consumption</b>	5.1W
<b>Lamp shape</b>	A60
<b>Dimmable</b>	Yes
<b>Beam angle</b>	360°
<b>Colour rendering index</b>	80
<b>Average rated life</b>	15,000 hours
<b>Switching cycles</b>	≥50,000 cycles

### Product range

Code	Description
AT9476/ES/WW/C SKU: 10017	A60 Filament 5.1W Dimmable 2700K ES/E27 Clear - 470lm
AT9476/BC/WW/C SKU: 10006	A60 Filament 5.1W Dimmable 2700K BC/B22 Clear - 470lm



## AT9421

6W Dimmable Candle Lamp - Frosted

### Product specification

<b>Voltage</b>	230~50Hz
<b>Power consumption</b>	6W
<b>Light colour options</b>	Warm white, Cool white & Daylight
<b>Colour temperature</b>	3000K, 4000K & 6500K
<b>Lamp shape</b>	C35
<b>Dimmable</b>	Yes
<b>Beam angle</b>	300°
<b>Colour rendering index</b>	>80
<b>Average rated life</b>	15,000 hours
<b>Switching cycles</b>	≥50,000 cycles

### Product range

Code	Description
<b>AT9421/ES/WW</b> SKU: 18444	6W Dimmable Candle lamp - Warm white 3000K ES/E27 Frosted - 490lm
<b>AT9421/ES/CW</b> SKU: 10751	6W Dimmable Candle lamp - Cool white 4000K ES/E27 Frosted - 500lm
<b>AT9421/ES/DL</b> SKU: 12516	6W Dimmable Candle lamp - Daylight 6500K ES/E27 Frosted - 500lm
<b>AT9421/BC/WW</b> SKU: 10645	6W Dimmable Candle lamp - Warm white 3000K BC/B22 Frosted - 490lm
<b>AT9421/BC/CW</b> SKU: 10747	6W Dimmable Candle lamp - Cool white 4000K BC/B22 Frosted - 500lm
<b>AT9421/BC/DL</b> SKU: 15794	6W Dimmable Candle lamp - Daylight 6500K BC/B22 Frosted - 500lm
<b>AT9421/SES/WW</b> SKU: 16935	6W Dimmable Candle lamp - Warm white 3000K SES/E14 Frosted - 490lm
<b>AT9421/SES/CW</b> SKU: 15719	6W Dimmable Candle lamp - Cool white 4000K SES/E14 Frosted - 500lm
<b>AT9421/SES/DL</b> SKU: 12896	6W Dimmable Candle lamp - Daylight 6500K SES/E14 Frosted - 500lm
<b>AT9421/SBC/WW</b> SKU: 10104	6W Dimmable Candle lamp - Warm white 3000K SBC/B15 Frosted - 490lm
<b>AT9421/SBC/CW</b> SKU: 12560	6W Dimmable Candle lamp - Cool white 4000K SBC/B15 Frosted - 500lm

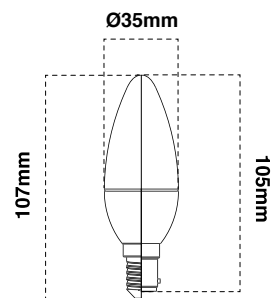
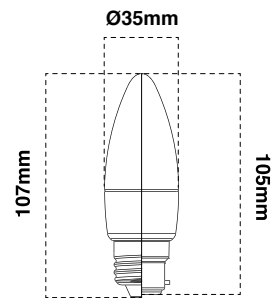

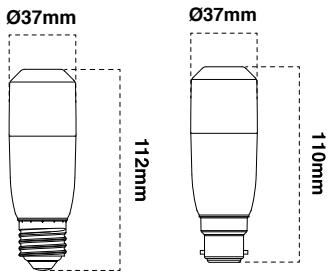
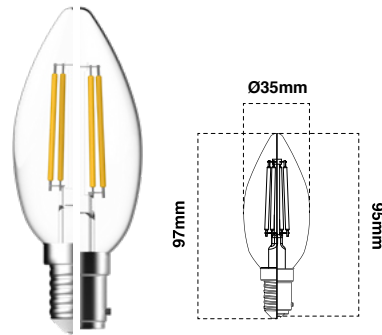
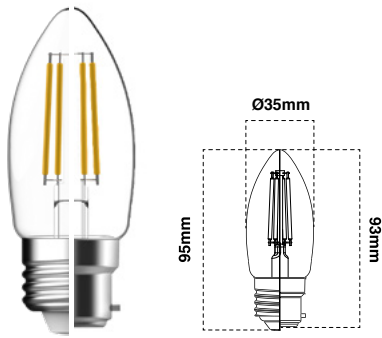

## AT9471

4.8W Dimmable Candle Lamp - Clear

### Product specification

<b>Voltage</b>	230~50Hz
<b>Power consumption</b>	4.8W
<b>Lamp shape</b>	C35
<b>Dimmable</b>	Yes
<b>Beam angle</b>	360°
<b>Colour rendering index</b>	>80
<b>Average rated life</b>	15,000 hours
<b>Switching cycles</b>	≥50,000 cycles

### Product range

Code	Description
AT9471/ES/WW/C SKU: 12777	C35 Filament 4.8W Dimmable 2700K ES/E27 Clear - 470lm
AT9471/BC/WW/C SKU: 12782	C35 Filament 4.8W Dimmable 2700K BC/B22 Clear - 470lm
AT9471/SES/WW/C SKU: 10763	C35 Filament 4.8W Dimmable 2700K SES/E14 Clear - 470lm
AT9471/SBC/WW/C SKU: 12785	C35 Filament 4.8W Dimmable 2700K SBC/B15 Clear - 470lm

## AT9431

9W Dimmable Stick Lamp - Frosted

### Product specification

<b>Voltage</b>	230~50Hz
<b>Power consumption</b>	9W
<b>Lamp shape</b>	Stick
<b>Dimmable</b>	Yes
<b>Beam angle</b>	240°
<b>Colour rendering index</b>	>80
<b>Average rated life</b>	15,000 hours
<b>Switching cycles</b>	≥50,000 cycles

### Product range

Code	Description
AT9431/ES/WW SKU: 13294	Stick Lamp 9W Dimmable 3000K ES/E27 Frosted - 850lm
AT9431/ES/CW SKU: 13256	Stick Lamp 9W Dimmable 4000K ES/E27 Frosted - 900lm
AT9431/ES/DL SKU: 13219	Stick Lamp 9W Dimmable 6500K ES/E27 Frosted - 900lm
AT9431/BC/WW SKU: 13283	Stick Lamp 9W Dimmable 3000K BC/B22 Frosted - 850lm
AT9431/BC/CW SKU: 13216	Stick Lamp 9W Dimmable 4000K BC/B22 Frosted - 900lm
AT9431/BC/DL SKU: 13298	Stick Lamp 9W Dimmable 6500K BC/B22 Frosted - 900lm

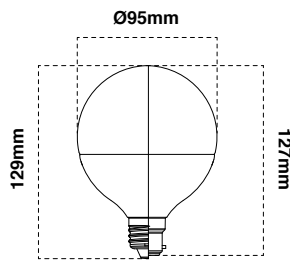

## AT9427

13W Non - Dimmable G95 Lamp - Frosted

### Product specification

<b>Voltage</b>	230~50Hz
<b>Power consumption</b>	13W
<b>Lamp shape</b>	G95
<b>Dimmable</b>	No
<b>Beam angle</b>	150°
<b>Colour rendering index</b>	80
<b>Average rated life</b>	15,000 hours
<b>Switching cycles</b>	≥50,000 cycles

### Product range

Code	Description
AT9427/ES/WW SKU: 13292	G95 13W Non - Dimmable 3000K ES/E27 Frosted - 1055lm
AT9427/ES/CW SKU: 13260	G95 13W Non - Dimmable 4000K ES/E27 Frosted - 1055lm
AT9427/ES/DL SKU: 13282	G95 13W Non - Dimmable 6500K ES/E27 Frosted - 1055lm
AT9427/BC/WW SKU: 13302	G95 13W Non - Dimmable 3000K BC/B22 Frosted - 1055lm
AT9427/BC/CW SKU: 13214	G95 13W Non - Dimmable 4000K BC/B22 Frosted - 1055lm
AT9427/BC/DL SKU: 13234	G95 13W Non - Dimmable 6500K BC/B22 Frosted - 1055lm

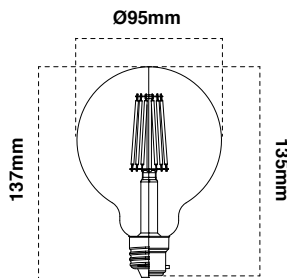

## AT9477

7.7W Dimmable G95 Filament Lamp - Clear

### Product specification

<b>Voltage</b>	230~50Hz
<b>Power consumption</b>	7.7W
<b>Lamp shape</b>	G95
<b>Dimmable</b>	Yes
<b>Beam angle</b>	360°
<b>Colour rendering index</b>	80
<b>Average rated life</b>	15,000 hours
<b>Switching cycles</b>	≥50,000 cycles

### Product range

Code	Description
AT9477/ES/WW/C SKU: 10024	G95 Filament 7.7W Dimmable 2700K ES/E14 Clear - 1055lm
AT9477/BC/WW/C SKU: 10021	G95 Filament 7.7W Dimmable 2700K BC/B22 Clear - 1055lm

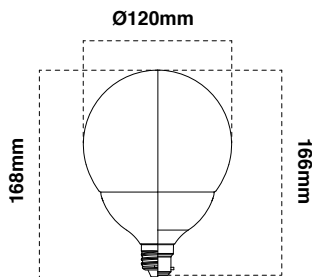

## AT9428

13W Non - Dimmable G120 Lamp - Frosted

### Product specification

<b>Voltage</b>	230~50Hz
<b>Power consumption</b>	13W
<b>Light colour options</b>	Warm white, Cool white & Daylight
<b>Colour temperature</b>	3000K, 4000K & 6500K
<b>Lamp shape</b>	G120
<b>Dimmable</b>	No
<b>Beam angle</b>	150°
<b>Colour rendering index</b>	80
<b>Average rated life</b>	15,000 hours
<b>Switching cycles</b>	≥50,000 cycles

### Product range

Code	Description
<b>AT9428/ES/WW</b> SKU: 10975	G95 13W Non - Dimmable 3000K ES/E27 Frosted - Warm white - 1055lm
<b>AT9428/ES/CW</b> SKU: 10876	G95 13W Non - Dimmable 4000K ES/E27 Frosted - Cool white - 1055lm
<b>AT9428/ES/DL</b> SKU: 10758	G95 13W Non - Dimmable 6500K ES/E27 Frosted - Daylight - 1055lm
<b>AT9428/BC/WW</b> SKU: 10029	G95 13W Non - Dimmable 3000K BC/B22 Frosted - Warm white - 1055lm
<b>AT9428/BC/CW</b> SKU: 10536	G95 13W Non - Dimmable 4000K BC/B22 Frosted - Cool white - 1055lm
<b>AT9428/BC/DL</b> SKU: 10990	G95 13W Non - Dimmable 6500K BC/B22 Frosted - Daylight - 1055lm

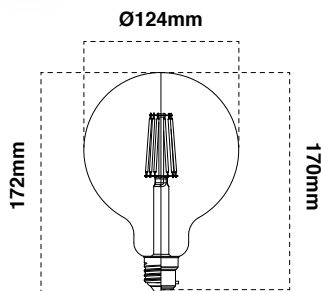

## AT9478

7.7W Dimmable G120 Filament Lamp - Clear

### Product specification

<b>Voltage</b>	230~50Hz
<b>Power consumption</b>	7.7W
<b>Lamp shape</b>	G95
<b>Dimmable</b>	Yes
<b>Beam angle</b>	360°
<b>Colour rendering index</b>	80
<b>Average rated life</b>	15,000 hours
<b>Switching cycles</b>	≥50,000 cycles

### Product range

Code	Description
<b>AT9478/ES/WW/C</b> SKU: 10792	G120 Filament 7.7W Dimmable 2700K ES/E14 Clear - 1055lm
<b>AT9478/BC/WW/C</b> SKU: 10769	G120 Filament 7.7W Dimmable 2700K BC/B22 Clear - 1055lm



## AT9422

6W Dimmable G45 Fancy Round Lamp - Frosted

### Product specification

<b>Voltage</b>	230~50Hz
<b>Power consumption</b>	6W
<b>Lamp shape</b>	G45
<b>Dimmable</b>	Yes
<b>Beam angle</b>	300°
<b>Colour rendering index</b>	>80
<b>Average rated life</b>	15,000 hours
<b>Switching cycles</b>	≥50,000 cycles

### Product range

Code	Description
<b>AT9422/BC/WW</b> SKU: 12047	6W Dimmable Fancy Round Lamp - Cool White 3000K BC/B22 Frosted - 490lm
<b>AT9422/BC/CW</b> SKU: 16599	6W Dimmable Fancy Round Lamp - Cool White 4000K BC/B22 Frosted - 490lm
<b>AT9422/BC/DL</b> SKU: 16804	6W Dimmable Fancy Round Lamp - Cool White 6500K BC/B22 Frosted - 500lm
<b>AT9422/ES/WW</b> SKU: 11960	6W Dimmable Fancy Round Lamp - Cool White 3000K ES/E272 Frosted - 490lm
<b>AT9422/ES/CW</b> SKU: 18233	6W Dimmable Fancy Round Lamp - Cool White 4000K ES/E27 Frosted - 490lm
<b>AT9422/ES/DL</b> SKU: 11011	6W Dimmable Fancy Round Lamp - Cool White 6500K ES/E27 Frosted - 500lm
<b>AT9422/SBC/WW</b> SKU: 10741	6W Dimmable Fancy Round Lamp - Cool White 3000K SBC/B15 Frosted - 490lm
<b>AT9422/SBC/CW</b> SKU: 16748	6W Dimmable Fancy Round Lamp - Cool White 4000K SBC/B15 Frosted - 490lm
<b>AT9422/SBC/DL</b> SKU: 14643	6W Dimmable Fancy Round Lamp - Cool White 6500K SBC/B15 Frosted - 500lm
<b>AT9422/SES/WW</b> SKU: 17630	6W Dimmable Fancy Round Lamp - Cool White 3000K SES/E14 Frosted - 490lm
<b>AT9422/SES/CW</b> SKU: 18316	6W Dimmable Fancy Round Lamp - Cool White 4000K SES/E14 Frosted - 490lm
<b>AT9422/SES/DL</b> SKU: 14772	6W Dimmable Fancy Round Lamp - Cool White 6500K SES/E14 Frosted - 500lm

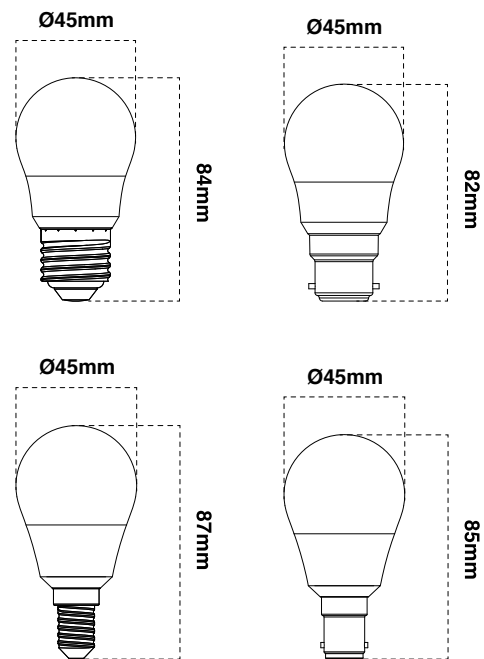

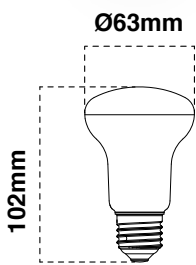

## AT9724

6.5W Non - Dimmable R63 Lamp - Frosted

### Product specification

<b>Voltage</b>	230~50Hz
<b>Power consumption</b>	6.5W
<b>Lamp shape</b>	R63
<b>Dimmable</b>	No
<b>Beam angle</b>	100°
<b>Colour rendering index</b>	>80
<b>Average rated life</b>	15,000 hours
<b>Switching cycles</b>	≥50,000 cycles

### Product range

Code	Description
AT9724/ES/WW SKU: 11224	R63 6.5W Non - Dimmable 3000K ES/E27 Frosted - 420lm
AT9724/ES/CW SKU: 11156	R63 6.5W Non - Dimmable 4000K ES/E27 Frosted - 490lm
AT9724/ES/DL SKU: 11349	R63 6.5W Non - Dimmable 6500K ES/E27 Frosted - 490lm

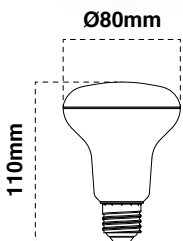

## AT9721

9.3W Non - Dimmable R80 Lamp - Frosted

### Product specification

<b>Voltage</b>	230~50Hz
<b>Power consumption</b>	9.3W
<b>Lamp shape</b>	R80
<b>Dimmable</b>	No
<b>Beam angle</b>	100°
<b>Colour rendering index</b>	>80
<b>Average rated life</b>	15,000 hours
<b>Switching cycles</b>	≥50,000 cycles

### Product range

Code	Description
AT9721/ES/WW SKU: 11444	R80 9.3W Non - Dimmable 3000K ES/E27 Frosted - 840lm
AT9721/ES/CW SKU: 11353	R80 9.3W Non - Dimmable 4000K ES/E27 Frosted - 890lm
AT9721/ES/DL SKU: 11416	R80 9.3W Non - Dimmable 6500K ES/E27 Frosted - 890lm

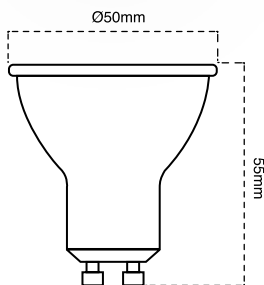
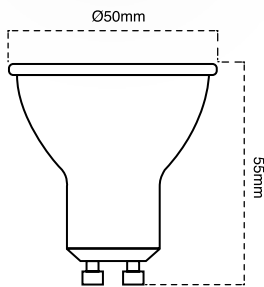

## AT9450

4W Non - Dimmable LED GU10 Lamp

### Product specification

<b>Voltage</b>	230~50Hz
<b>Power consumption</b>	4W
<b>Lamp shape</b>	GU10
<b>Dimmable</b>	No
<b>Beam angle</b>	36°
<b>Colour rendering index</b>	80
<b>Average rated life</b>	15,000 hours
<b>Switching cycles</b>	≥50,000 cycles

### Product range

Code	Description
<b>AT9450/36/WW</b> SKU: 10563	4W GU10 36° Lamp - Warm White 3000K - 270lm
<b>AT9450/36/CW</b> SKU: 10557	4W GU10 36° Lamp - Warm White 4000K - 300lm
<b>AT9450/36/DL</b> SKU: 10598	4W GU10 36° Lamp - Warm White 6500K - 300lm

## AT9451

6.7W Dimmable LED GU10 Lamp

### Product specification

<b>Voltage</b>	230~50Hz
<b>Power consumption</b>	6.7W
<b>Lamp shape</b>	GU10
<b>Dimmable</b>	Yes
<b>Beam angle</b>	36° & 60°
<b>Colour rendering index</b>	80
<b>Average rated life</b>	15,000 hours
<b>Switching cycles</b>	≥50,000 cycles

### Product range

Code	Description
<b>AT9451/36/WW</b> SKU: 10623	6.7W Dimmable GU10 36° Lamp - Cool White 3000K - 650lm
<b>AT9451/36/CW</b> SKU: 10589	6.7W Dimmable GU10 36° Lamp - Warm White 4000K - 700lm
<b>AT9451/36/DL</b> SKU: 10670	6.7W Dimmable GU10 36° Lamp - Daylight 6500K - 700lm
<b>AT9451/60/WW</b> SKU: 10755	6.7W Dimmable GU10 60° Lamp - Warm White 3000K - 600lm
<b>AT9451/60/CW</b> SKU: 15940	6.7W Dimmable GU10 60° Lamp - Cool White 4000K - 680lm
<b>AT9451/60/DL</b> SKU: 16001	6.7W Dimmable GU10 60° Lamp - Daylight 6500K - 680lm



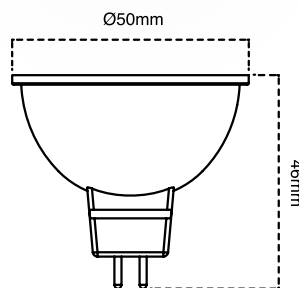
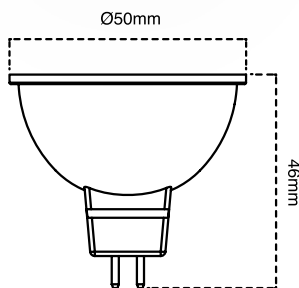

## AT9452

3.1W Non - Dimmable LED MR16 Lamp

### Product specification

<b>Voltage</b>	230~50Hz
<b>Power consumption</b>	3.1W
<b>Lamp shape</b>	MR16
<b>Dimmable</b>	No
<b>Beam angle</b>	36° & 60°
<b>Colour rendering index</b>	80
<b>Average rated life</b>	15,000 hours
<b>Switching cycles</b>	≥50,000 cycles

### Product range

Code	Description
AT9452/36/WW SKU: 10721	3.1W MR16 36° Lamp - Cool White 3000K - 270lm
AT9452/36/CW SKU: 10712	3.1W MR16 36° Lamp - Warm White 4000K - 290lm
AT9452/36/DL SKU: 10821	3.1W MR16 36° Lamp - Daylight 6500K - 290lm
AT9452/60/WW SKU: 10794	3.1W MR16 60° Lamp - Warm White 3000K - 270lm
AT9452/60/CW SKU: 10703	3.1W MR16 60° Lamp - Cool White 4000K - 290lm
AT9452/60/DL SKU: 10834	3.1W MR16 60° Lamp - Daylight 6500K - 290lm

## AT9453

6W Non - Dimmable LED MR16 Lamp

### Product specification

<b>Voltage</b>	230~50Hz
<b>Power consumption</b>	6W
<b>Lamp shape</b>	MR16
<b>Dimmable</b>	No
<b>Beam angle</b>	36° & 60°
<b>Colour rendering index</b>	80
<b>Average rated life</b>	15,000 hours
<b>Switching cycles</b>	≥50,000 cycles

### Product range

Code	Description
AT9453/36/WW SKU: 16359	6W MR16 36° Lamp - Warm White 3000K - 520lm
AT9453/36/CW SKU: 10841	6W MR16 36° Lamp - Cool White 3000K - 520lm
AT9453/36/DL SKU: 10855	6W MR16 36° Lamp - Daylight 6500K - 520lm
AT9453/60/WW SKU: 10679	6W MR16 60° Lamp - Warm White 3000K - 520lm
AT9453/60/CW SKU: 10949	6W MR16 60° Lamp - Cool White 3000K - 520lm
AT9453/60/DL SKU: 11087	6W MR16 60° Lamp - Daylight 6500K - 520lm



## AT9480

5.1W Dimmable ST64 Filament Lamp - Golden Clear

### Product specification

<b>Voltage</b>	230~50Hz
<b>Power consumption</b>	5.1W
<b>Lamp shape</b>	ST64
<b>Dimmable</b>	Yes
<b>Beam angle</b>	360°
<b>Colour rendering index</b>	80
<b>Average rated life</b>	15,000 hours
<b>Switching cycles</b>	≥50,000 cycles

### Product range

Code	Description
<b>AT9480/ES/WW/GC</b> SKU: 10840	ST64 Filament 5.1W Dimmable 2500K ES/E27 Golden Clear - 380lm
<b>AT9480/BC/WW/GC</b> SKU: 10880	ST64 Filament 5.1W Dimmable 2500K BC/B22 Golden Clear - 380lm

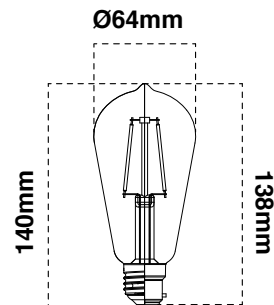



## AT9481

8.3W Dimmable ST64 Filament Lamp - Golden Clear

### Product specification

<b>Voltage</b>	230~50Hz
<b>Power consumption</b>	8.3W
<b>Lamp shape</b>	ST64
<b>Dimmable</b>	Yes
<b>Beam angle</b>	360°
<b>Colour rendering index</b>	80
<b>Average rated life</b>	15,000 hours
<b>Switching cycles</b>	≥50,000 cycles

### Product range

Code	Description
AT9481/ES/WW/GC SKU: 10983	ST64 Filament 8.3W Dimmable 2500K ES/E27 Golden Clear - 660lm
AT9481/BC/WW/GC SKU: 11005	ST64 Filament 8.3W Dimmable 2500K BC/B22 Golden Clear - 660lm

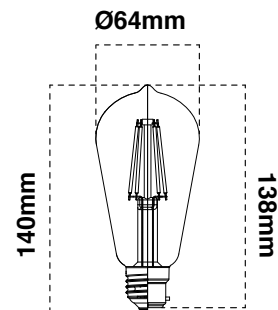

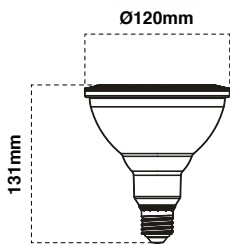

CUT-OUT: Ø45mm  
Dimensions: 103mm x Ø50mm

## AT9425

16W Weatherproof PAR38 Lamp - Frosted

### Product specification

Voltage	230~50Hz
Power consumption	16W
Lamp shape	PAR38
Dimmable	No
Beam angle	100°
Colour rendering index	80
Average rated life	15,000 hours
Switching cycles	≥50,000 cycles
IP Rating	IP65

### Product range

Code	Description
AT9425/ES/WW SKU: 11536	PAR38 16W Weatherproof IP65 3000K ES/E27 - 1400lm
AT9425/ES/CW SKU: 11591	PAR38 16W Weatherproof IP65 4000K ES/E27 - 1400lm
AT9425/ES/DL SKU: 11486	PAR38 16W Weatherproof IP65 5000K ES/E27 - 1400lm

## AT9120

10W LED Lamp with Dimmable LED Driver

### Product specification

Voltage	230~50Hz
Power consumption	10W
Dimmable	Yes
Beam angle	60°
Colour rendering index	80
Average rated life	15,000 hours
Switching cycles	≥50,000 cycles

### Product range

Code	Description
AT9120/WW/60 SKU: 10651	10W LED Lamp with Dimmable LED Driver - Warm White - 60° Beam - 590lm
AT9120/CW/60 SKU: 10533	10W LED Lamp with Dimmable LED Driver - Cool White - 60° Beam - 600lm

## REMOTE



### **AT9612/WIZ/RC**

SKU 17955

WiZ Infra-red remote - can control a light + 4 light modes.

Suitable for *WiZ lights with Infrared compatibility*



## LED Exterior

Exterior lighting is essential for safety and wellbeing, being able to see walkways and entrances. The added bonus is the beauty that a perfect light can add to the entrance of any property.

# Overview

## LED EXTERIOR AND WORKLIGHTS

- UP/DOWN EXTERIOR LIGHTS 96
- WALL SPOTS EXTERIOR LIGHTS 97
- SPOTLIGHTS 98
- SPOTLIGHTS WITH SENSOR 99
- GARDEN SPIKES 100 - 101
- BOLLARDS 102
- WORKLIGHT 103



atom

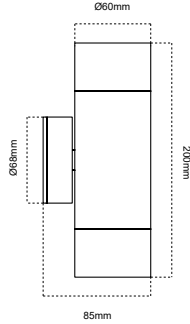

**Finish**

- Anodised aluminium
- Anodised titanium
- Anodised black
- Stainless steel (316)
- White

## AT5004

2 x 6W LED Up/Down Light

**Product specification**

<b>Voltage</b>	230~50Hz
<b>Power consumption</b>	2 x 6W
<b>Light colour options</b>	Cool white
<b>Colour temperature</b>	4000K
<b>Beam angle</b>	38°
<b>Dimmable</b>	No
<b>Lamp type</b>	GU10
<b>IP Rating</b>	IP65

**Product range**

Code	Description
<b>AT5004/AND/LED</b> SKU: 12674	2 x 6W LED Anodised Aluminium Up/Down Light - 2 x 570lm
<b>AT5004/AND/AT/LED</b> SKU: 12780	2 x 6W LED Anodised Aluminium Titanium Up/Down Light - 2 x 570lm
<b>AT5005/AND/BLK/LED</b> SKU: 12747	6W LED Anodised Aluminium Adjustable Black Wall Spot - 2 x 570lm
<b>AT5004/316/LED</b> SKU: 12831	2x 6W LED - 316L Stainless Steel Up/Down Light - 2 x 570lm
<b>AT5004/WHT/LED</b> SKU: 12576	2 x 6W LED White Up/Down Light - 2 x 570lm

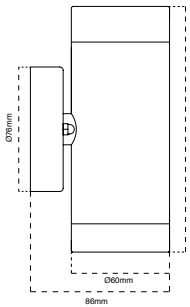

**Finish**

- Stainless steel (304)

## AT5007

2 x 3.5W LED Up/Down Light

**Product specification**

<b>Voltage</b>	230~50Hz
<b>Power consumption</b>	2 x 3.5W
<b>Light colour options</b>	Cool white
<b>Colour temperature</b>	4000K
<b>Beam angle</b>	38°
<b>Dimmable</b>	No
<b>Lamp type</b>	GU10
<b>IP Rating</b>	IP44

**Product range**

Code	Description
<b>AT5007</b> SKU: 10293	304 Stainless Steel Up/Down Light LED - 2 x 250lm



## AT5006

6W LED Fixed Wall Spot

### Product specification

<b>Voltage</b>	230~50Hz
<b>Power consumption</b>	6W
<b>Light colour options</b>	Cool white
<b>Colour temperature</b>	4000K
<b>Beam angle</b>	36°
<b>Dimmable</b>	No
<b>Lamp type</b>	GU10
<b>IP Rating</b>	IP65

### Product range

Code	Description
AT5006/AND/BLK/LED SKU: 16188	6W LED Anodised Aluminium Fixed Wall Spot - Black - 570lm



### Finish

■ Anodised black

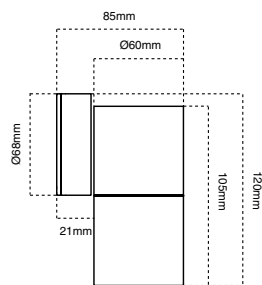

## AT5005

6W LED Adjustable Wall Spot

### Product specification

<b>Voltage</b>	230~50Hz
<b>Power consumption</b>	6W
<b>Light colour options</b>	Cool white
<b>Colour temperature</b>	4000K
<b>Beam angle</b>	38°
<b>Dimmable</b>	No
<b>Lamp type</b>	GU10
<b>IP Rating</b>	IP65

### Product range

Code	Description
AT5005/AND/LED SKU: 12607	6W LED Anodised Aluminium Adjustable Wall Spot - 570lm
AT5005/AND/BLK/LED SKU: 12694	6W LED Anodised Aluminium Adjustable Black Wall Spot - 570lm

### Finish

■ Anodised aluminium

■ Anodised black

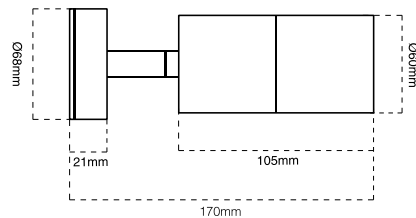



### Finish

Black
  Silver
  White

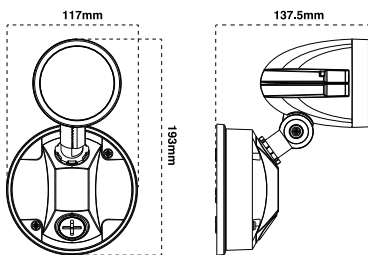

## AT9130

10W LED Single Spotlight

### Product specification

<b>Voltage</b>	230~50Hz
<b>Power consumption</b>	10W
<b>Light colour options</b>	Daylight
<b>Colour temperature</b>	5000K
<b>Beam angle</b>	115°
<b>Dimmable</b>	No
<b>IP Rating</b>	IP44

### Product range

Code	Description
AT9130/BLK SKU: 10060	10W IP44 Black LED Single Spotlight - 1100lm
AT9130/SIL SKU: 10062	10W IP44 Silver LED Single Spotlight - 1100lm
AT9130/WH SKU: 10105	10W IP44 White LED Single Spotlight - 1100lm



### Finish

Black
  Silver
  White

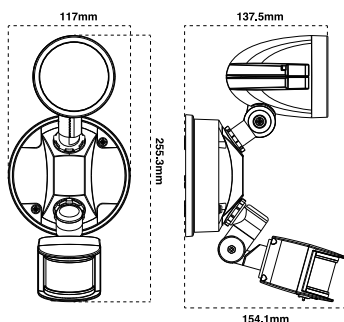

## AT9131

10W LED Single Spotlight with sensor

### Product specification

<b>Voltage</b>	230~50Hz
<b>Power consumption</b>	10W
<b>Light colour options</b>	Daylight
<b>Colour temperature</b>	5000K
<b>Beam angle</b>	115°
<b>Dimmable</b>	No
<b>IP Rating</b>	IP44

### Product range

Code	Description
AT9131/BLK SKU: 10132	10W IP44 Black LED Twin Spotlight with sensor - 1000lm
AT9131/SIL SKU: 10107	10W IP44 Silver LED Twin Spotlight with sensor - 1000lm
AT9131/WH SKU: 10134	10W IP44 White LED Single Spotlight with sensor - 1000lm

# atom<sup>i</sup>



### Finish

Black
  Silver
  White

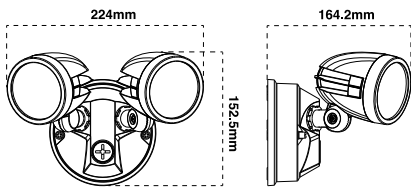

### Finish

Black
  Silver
  White

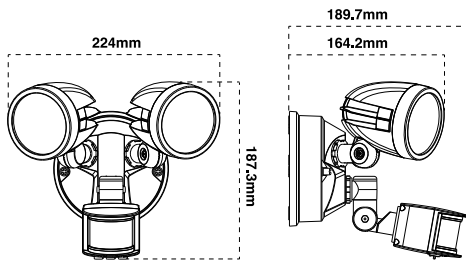

## AT9132

2 x 10W LED Twin Spotlight

### Product specification

<b>Voltage</b>	230~50Hz
<b>Power consumption</b>	20W
<b>Light colour options</b>	Daylight
<b>Colour temperature</b>	5000K
<b>Beam angle</b>	115°
<b>Dimmable</b>	No
<b>IP Rating</b>	IP44

### Product range

Code	Description
AT9132/BLK SKU: 10136	20W IP44 Black LED Twin Spotlight - 2300lm
AT9132/SIL SKU: 10138	20W IP44 Silver LED Twin Spotlight - 2300lm
AT9132/WH SKU: 10140	20W IP44 White LED Twin Spotlight - 2300lm

## AT9133

2 x 10W LED Twin Spotlight with sensor

### Product specification

<b>Voltage</b>	230~50Hz
<b>Power consumption</b>	24W
<b>Light colour options</b>	Cool white
<b>Colour temperature</b>	4000K
<b>Beam angle</b>	115°
<b>Dimmable</b>	No
<b>IP Rating</b>	IP44

### Product range

Code	Description
AT9133/BLK SKU: 10152	20W IP44 Black LED Twin Spotlight with sensor - 2200lm
AT9133/SIL SKU: 10137	20W IP44 Silver LED Twin Spotlight with sensor - 2200lm
AT9133/WH SKU: 10142	20W IP44 White LED Twin Spotlight with sensor - 2200lm



## AT5101

6W LED 12V Spike Spot

### Product specification

<b>Voltage</b>	12V
<b>Power consumption</b>	6W
<b>Light colour options</b>	Cool white
<b>Colour temperature</b>	4000K
<b>Beam angle</b>	38°
<b>Dimmable</b>	No
<b>Lamp type</b>	MR16
<b>IP Rating</b>	IP65

### Product range

Code	Description
<b>AT5101/AND/LED</b> SKU: 12147	6W LED IP65 12v Anodised Aluminium Spike Spot - 570lm
<b>AT5101/316/LED</b> SKU: 11947	6W LED IP65 12v 316L Stainless Steel Spike Spot - 570lm
<b>AT5101/AND/BLK/LED</b> SKU: 12084	6W LED IP65 12v Spike Spot Anodised Aluminium - Black - 570lm
<b>AT5101/BLK/LED</b> SKU: 12205	6W LED IP65 12v Spike Spot - Black - 570lm

### Finish

- Anodised aluminium
- Anodised black
- Stainless steel (316)
- Black

### Compatible drivers

<b>AT - 28000507</b> SKU: 12945 12Vdc - 15W IP67 LED Driver
<b>AT - 28000508</b> SKU: 11169 12Vdc - 35W IP67 LED Driver
<b>AT - 28000509</b> SKU: 11257 12Vdc - 60W IP67 LED Driver
<b>AT - 28000510</b> SKU: 11291 12Vdc - 35W IP67 LED Driver
<b>AT030VA W/P</b> SKU: 10321 30VA Weatherproof transformer
<b>AT050VA W/P</b> SKU: 10445 50W Weatherproof transformer
<b>AT060VA W/P</b> SKU: 10665 60W Mini Weatherproof transformer
<b>AT100VA W/P</b> SKU: 10573 100W Mini Weatherproof transformer
<b>AT105VA W/P</b> SKU: 10650 105W Mini Weatherproof transformer
<b>AT200VA W/P</b> SKU: 10575 200W Weatherproof transformer
<b>AT300VA W/P</b> SKU: 10524 300W Weatherproof transformer
<b>AT400VA W/P</b> SKU: 10722 400W Weatherproof transformer

Must use appropriate driver. Sold separately.

atom

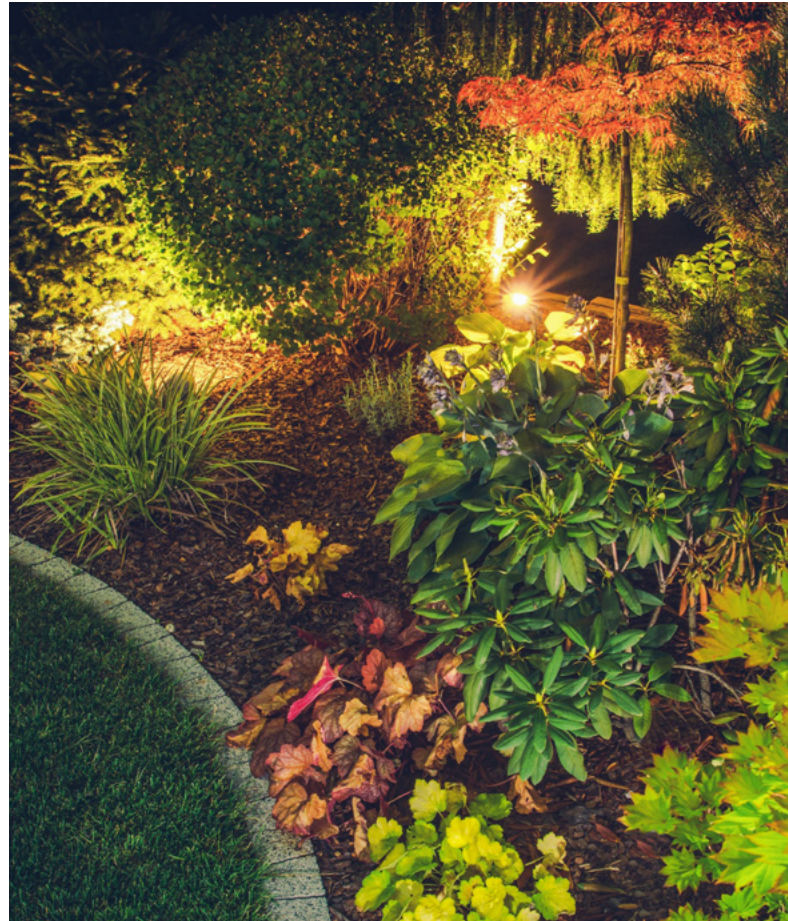
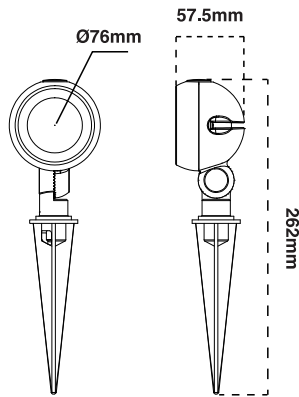

## AT5107

6W & 10W LED Garden Spike Light

### Product specification

<b>Voltage</b>	12V
<b>Power consumption</b>	6W & 10W
<b>Light colour options</b>	Warm white & Daylight
<b>Colour temperature</b>	3000K & 5000K
<b>Beam angle</b>	60°
<b>Dimmable</b>	No
<b>IP Rating</b>	IP65

### Product range

Code	Description
<b>AT5107/6/BLK/WW</b> SKU: 11781	6W LED Garden Spike light - Black - Warm White - 490lm
<b>AT5107/6/BLK/DL</b> SKU: 11754	6W LED Garden Spike Light - Black - Daylight - 510lm
<b>AT5107/10/BLK/WW</b> SKU: 11834	10W LED Garden Spike Light - Black - Warm White - 850lm
<b>AT5107/10/BLK/DL</b> SKU: 11809	10W LED Garden Spike Light - Black - Daylight - 880lm

### Finish

■ Black

### Compatible drivers

<b>AT - 28000507</b> SKU: 12945	12Vdc - 15W IP67 LED Driver
<b>AT - 28000508</b> SKU: 11169	12Vdc - 35W IP67 LED Driver
<b>AT - 28000509</b> SKU: 11257	12Vdc - 60W IP67 LED Driver
<b>AT - 28000510</b> SKU: 11291	12Vdc - 35W IP67 LED Driver
<b>AT060VA W/P</b> SKU: 10665	60W Mini Weatherproof transformer
<b>AT105VA W/P</b> SKU: 10680	105W Mini Weatherproof transformer

Must use appropriate driver. Sold separately.



## AT5908

12V Bollard with clear diffuser

### Product specification

<b>Voltage</b>	12V
<b>Dimmable</b>	No
<b>Lamp type</b>	1 x MR16* (max. 6W)
<b>IP Rating</b>	IP65

\*Lamp not included

### Product range

Code	Description
<b>AT5908/AND/LED</b> SKU: 12850	12V LED 445mm Bollard light with clear diffuser - Anodised titanium
<b>AT5908/AND/BLK/LED</b> SKU: 12872	12V LED 445mm Bollard light with clear diffuser - Anodised black

### Suitable lamp range

Code	Description
<b>AT5908/AND/BLK/LED</b> SKU: 12872	12v LED 445mm Bollard light with clear diffuser - Anodised black
<b>AT5908/AND/LED</b> SKU: 12850	12v LED 445mm Bollard light with clear diffuser - Anodised titanium

### Finish

■ Anodised titanium    ■ Anodised black

### Accessories

**AT5908/EXT/AND/BLK**  
SKU: 12953  
380mm Extension for AT5908 Bollard Anodised Black

**AT5908/EXT/AND**  
SKU: 12941  
380mm Extension for AT5908 Bollard Anodised

### Compatible drivers

**AT-28000507**  
SKU: 12945  
12Vdc - 15W IP67 LED Driver

**AT-28000508**  
SKU: 11169  
12Vdc - 35W IP67 LED Driver

**AT-28000509**  
SKU: 11257  
12Vdc - 60W IP67 LED Driver

**AT-28000510**  
SKU: 11291  
12Vdc - 100W IP67 LED Driver

**AT060VA W/P**  
SKU: 10665  
60W Mini Weatherproof transformer

**AT105VA W/P**  
SKU: 10680  
105W Mini Weatherproof transformer

Must use appropriate driver. Sold separately.



## AT6002

10W LED Adjustable Security & Worklight

### Product specification

<b>Voltage</b>	230~50Hz
<b>Power consumption</b>	10W
<b>Light colour options</b>	Daylight
<b>Colour temperature</b>	5000K
<b>Lumen output</b>	1000lm
<b>Beam angle</b>	45°- 120°
<b>Dimmable</b>	No
<b>IP Rating</b>	IP54

### Product range

Code	Description
AT6002 SKU: 11250	10W LED Adjustable Security & Worklight

### Finish

■ Yellow

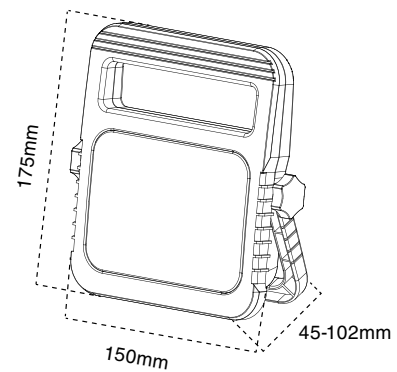



## Commercial Lighting

Lighting built tough to withstand harsh internal and external environments. Giving the light needed to secure your property and ensure safety for all.



# Overview

## COMMERCIAL LIGHTING

BACKLIT PANELS	106 - 107
TROFFER	108 - 109
FLOODLIGHTS	110 - 114
HIGHBAYS	115 - 116
WEATHERPROOF BATTENS	117 - 118
DIFFUSED BATTENS	119 - 120
WIRE GUARD BATTENS	121
ACCESSORIES	122 - 123

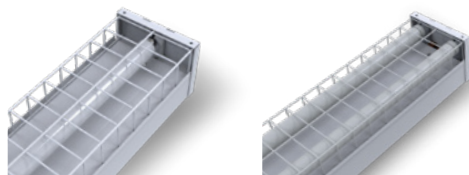
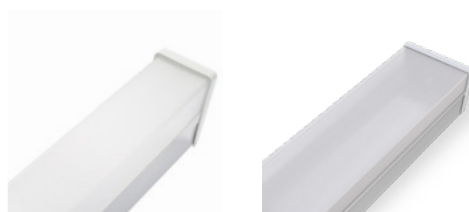



# AT6020

LED Backlit Panel

### Product specification

<b>Voltage</b>	230~50Hz
<b>Power consumption</b>	20W, 36W & 60W
<b>Dimmable</b>	No
<b>Colour temperature</b>	Cool white & Daylight
<b>Light colour options</b>	4000K & 6500K
<b>Beam angle</b>	120°
<b>IP Rating</b>	IP20
<b>Average rated life</b>	L70 (6K)>33,000 Hrs

### Product range

Code	Description
<b>AT6020/306/CW</b> SKU: 13106	20W LED Backlit panel 300 x 600mm - Cool white - 2050lm
<b>AT6020/306/DL</b> SKU: 13108	20W LED Backlit panel 300 x 600mm - Daylight - 2035lm
<b>AT6020/312/CW</b> SKU: 13160	36W LED Backlit panel 300 x 1200mm - Cool white - 3485lm
<b>AT6020/312/DL</b> SKU: 13172	36W LED Backlit panel 300 x 1200mm - Daylight - 3430lm
<b>AT6020/606/CW</b> SKU: 13135	36W LED Backlit panel 600 x 600mm - Cool white - 3600lm
<b>AT6020/606/DL</b> SKU: 13147	36W LED Backlit panel 600 x 600mm - Daylight - 3565lm
<b>AT6020/612/CW</b> SKU: 13186	60W LED Backlit panel 600 x 1200mm - Cool white - 6280lm
<b>AT6020/612/DL</b> SKU: 13199	60W LED Backlit panel 600 x 1200mm - Daylight - 6320lm

### Finish

White

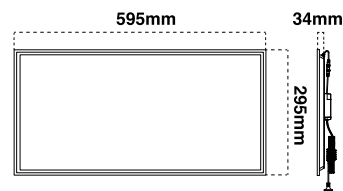
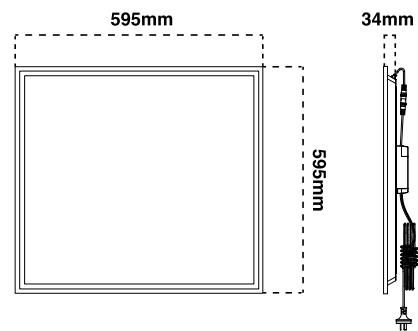
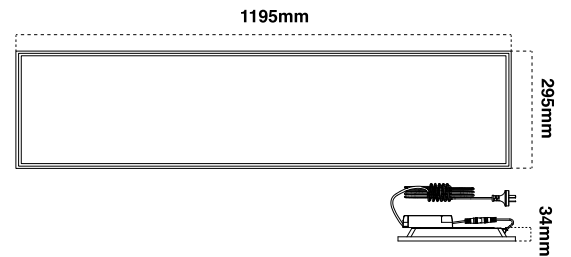
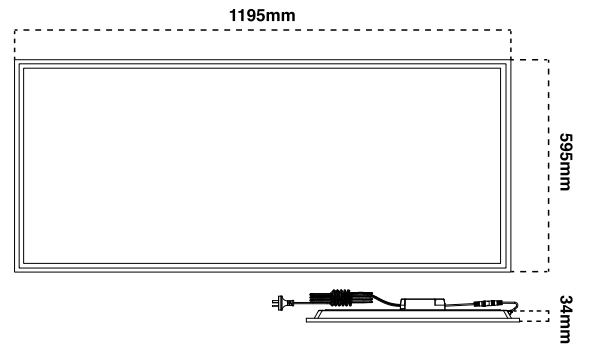
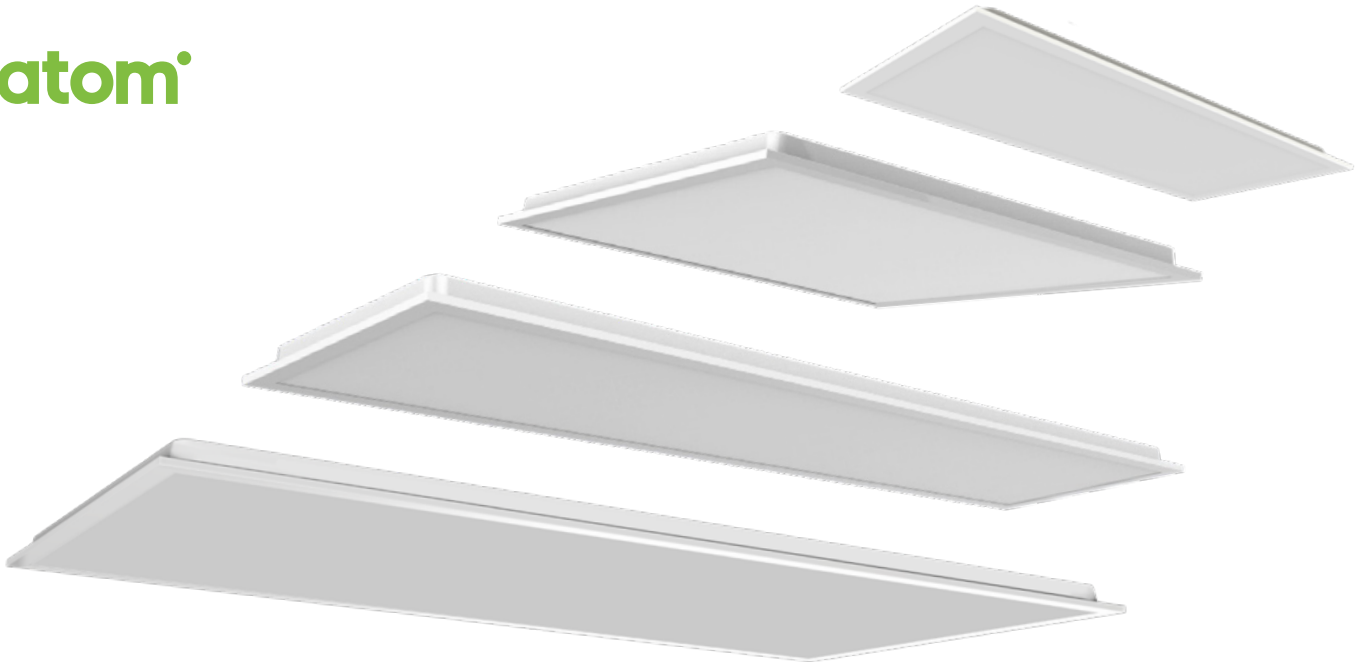

## AT6021

LED Backlit Panel

### Product specification

<b>Voltage</b>	230~50Hz
<b>Power consumption</b>	20W, 36W & 60W
<b>Dimmable</b>	No
<b>Colour temperature</b>	Cool white & Daylight
<b>Light colour options</b>	4000K & 6500K
<b>Beam angle</b>	90°
<b>Diffuser</b>	PC
<b>IP Rating</b>	IP20
<b>Average rated life</b>	L70 (10K) B10 >60,000 Hrs

### Product range

Code	Description
<b>AT6021/306/CW</b> SKU: 13110	20W LED Backlit panel 300 x 600mm - Cool white - 1975lm
<b>AT6021/306/DL</b> SKU: 131112	20W LED Backlit panel 300 x 600mm - Daylight - 1930lm
<b>AT6021/312/CW</b> SKU: 13332	36W LED Backlit panel 300 x 1200mm - Cool white - 3455lm
<b>AT6021/312/DL</b> SKU: 13346	36W LED Backlit panel 300 x 1200mm - Daylight - 3500lm
<b>AT6021/606/CW</b> SKU: 13311	36W LED Backlit panel 600 x 600mm - Cool white - 3680lm
<b>AT6021/606/DL</b> SKU: 13328	36W LED Backlit panel 600 x 600mm - Daylight - 3560lm
<b>AT6021/612/CW</b> SKU: 13355	60W LED Backlit panel 600 x 1200mm - Cool white - 5925lm
<b>AT6021/612/DL</b> SKU: 13367	60W LED Backlit panel 600 x 1200mm - Daylight - 5860lm

### Finish

White

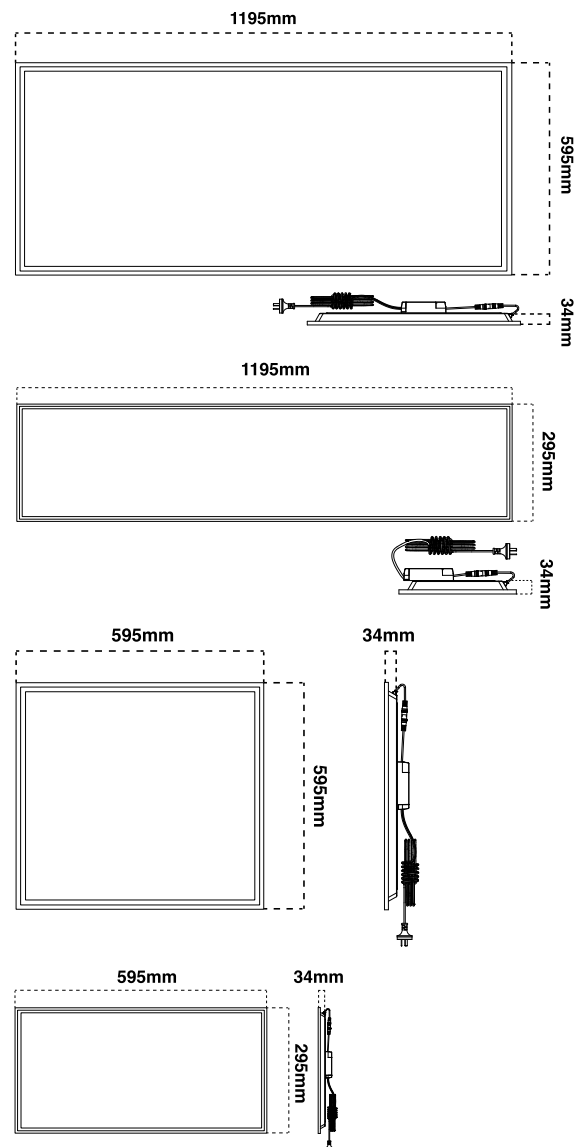



## AT7050 & AT7053

LED Low Glare Direct/Indirect Troffer

### Product specification

<b>Voltage</b>	230~50Hz
<b>Power consumption</b>	25W & 30W
<b>Dimmable</b>	DALI Dimmable
<b>Colour temperature</b>	Cool white
<b>Light colour options</b>	4000K
<b>Beam angle</b>	90°
<b>IP Rating</b>	IP40
<b>IC Rating</b>	IC-4
<b>Average rated life</b>	L70 (9K)B10 >54,000 Hrs

### Product range

Code	Description
<b>AT7050/WH/CW</b> SKU: 13106	30W LED Low Glare Direct/Indirect Troffer - Ø1200 x 300mm - Cool White 4000K - 3450lm
<b>AT7053/WH/CW</b> SKU: 13106	25W LED Low Glare Direct/Indirect Troffer - Ø600 x 300mm - Cool White 4000K - 2850lm

### Finish

White

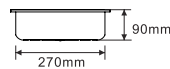
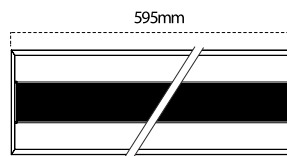
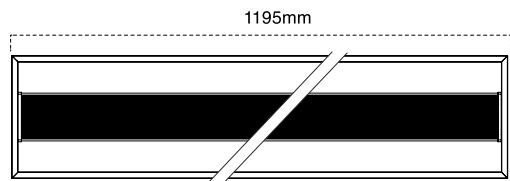



## AT9054

LED Low Glare Troffer

### Product specification

<b>Voltage</b>	230~50Hz
<b>Power consumption</b>	35W
<b>Light colour options</b>	Cool white
<b>Colour temperature</b>	4000K
<b>Dimmable</b>	No
<b>Beam angle</b>	90°
<b>IP Rating</b>	IP40

### Product range

Code	Description
AT9054/WH/CW SKU: 18974	35W LED Troffer Low Glare Ø1200 x 300mm - Cool White 4000K - 4000lm

### Finish

White

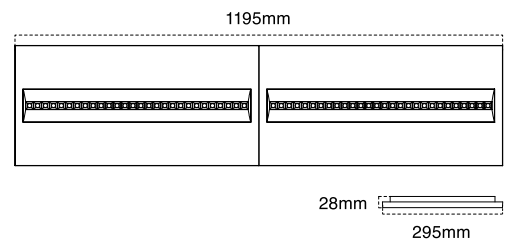



## AT9814

LED IP65 Floodlight

### Product specification

<b>Voltage</b>	230~50Hz
<b>Power consumption</b>	100W, 150W & 200W
<b>Light colour options</b>	Daylight
<b>Colour temperature</b>	5000K
<b>Dimmable</b>	No
<b>IP Rating</b>	IP66
<b>IK Rating</b>	IK08

### Product range

Code	Description
<b>AT99814/100</b> SKU: 17920	100W commercial LED Floodlight - 13380lm
<b>AT99814/150</b> SKU: 17816	150W commercial LED Floodlight - 19745lm
<b>AT99814/200</b> SKU: 10994	200W commercial LED Floodlight - 25540lm

### Finish

■ Black

### Accessories

**AT9812/PMB**  
SKU: 12207  
Pole mounting bracket.  
Suitable for AT9814

For full product list see pages 119 - 120

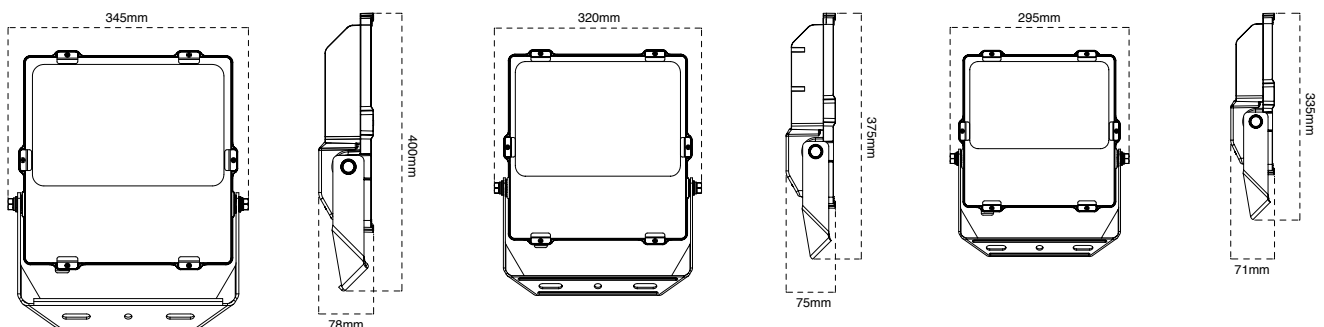

## AT9819/10

10W LED Slim Floodlight



### Finish

■ Black □ White

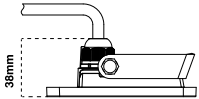
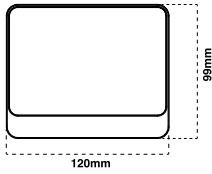

### Product specification

<b>Voltage</b>	230~50Hz
<b>Power consumption</b>	10W
<b>Light colour options</b>	Daylight
<b>Colour temperature</b>	5000K
<b>Beam angle</b>	120°
<b>Dimmable</b>	No
<b>IP Rating</b>	IP65

### Product range

Code	Description
AT9819/10/BLK SKU: 12038	10W Slim Floodlight - IP65 - Black - 910lm
AT9819/10/WH SKU: 11560	10W Slim Floodlight - IP65 - White - 910lm



### Finish

■ Black □ White

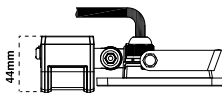
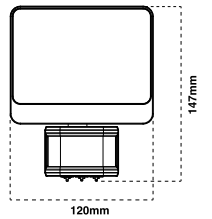

## AT9819/10/S

10W LED Slim Floodlight with sensor

### Product specification

<b>Voltage</b>	230~50Hz
<b>Power consumption</b>	10W
<b>Light colour options</b>	Daylight
<b>Colour temperature</b>	5000K
<b>Beam angle</b>	120°
<b>Dimmable</b>	No
<b>IP Rating</b>	IP44
<b>Detection range</b>	12m (at 1.8m mounting height)
<b>Duration time adjustment</b>	10±5 seconds to 4±minutes
<b>Detection circuitry</b>	Passive infra - red (PIR)

### Product range

Code	Description
AT9819/10/BLK/S SKU: 12112	10W Slim Floodlight - Black with Sensor - 860lm
AT9819/10/WH/S SKU: 11587	10W Slim Floodlight - White with Sensor - 860lm

## AT9819/20

20W LED Slim Floodlight



### Finish

■ Black □ White

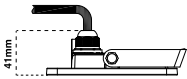
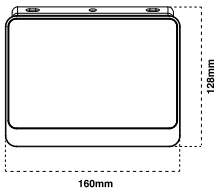

### Product specification

<b>Voltage</b>	230~50Hz
<b>Power consumption</b>	20W
<b>Light colour options</b>	Daylight
<b>Colour temperature</b>	5000K
<b>Beam angle</b>	120°
<b>Dimmable</b>	No
<b>IP Rating</b>	IP65

### Product range

Code	Description
AT9819/20/BLK SKU: 12206	20W Slim Floodlight - IP65 - Black - 1835lm
AT9819/20/WH SKU: 11653	20W Slim Floodlight - IP65 - White - 1835lm



### Finish

■ Black □ White

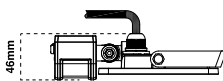
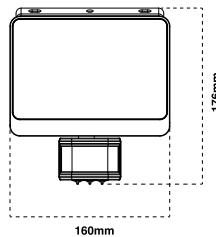

## AT9819/20/S

20W LED Slim Floodlight with sensor

### Product specification

<b>Voltage</b>	230~50Hz
<b>Power consumption</b>	20W
<b>Light colour options</b>	Daylight
<b>Colour temperature</b>	5000K
<b>Beam angle</b>	120°
<b>Dimmable</b>	No
<b>IP Rating</b>	IP44
<b>Detection range</b>	12m (at 1.8m mounting height)
<b>Duration time adjustment</b>	10±5 seconds to 4± minutes
<b>Detection circuitry</b>	Passive infra - red (PIR)

### Product range

Code	Description
AT9819/20/BLK/S SKU: 12285	20W Slim Floodlight - Black with Sensor -1690lm
AT9819/20/WH/S SKU: 11725	20W Slim Floodlight - White with Sensor -1690lm



# atom

## AT9819/30

30W LED Slim Floodlight

### Product specification

<b>Voltage</b>	230~50Hz
<b>Power consumption</b>	30W
<b>Light colour options</b>	Daylight
<b>Colour temperature</b>	5000K
<b>Beam angle</b>	120°
<b>Dimmable</b>	No
<b>IP Rating</b>	IP65

### Product range

Code	Description
<b>AT9819/30/BLK</b> SKU: 12340	30W Slim Floodlight - IP65 - Black - 2320lm
<b>AT9819/30/WH</b> SKU: 11793	30W Slim Floodlight - IP65 - White - 2320lm

### Finish

■ Black □ White

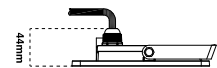
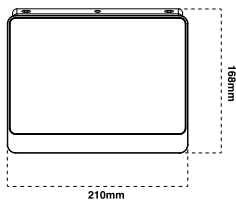

## AT9819/30/S

30W LED Slim Floodlight with sensor

### Product specification

<b>Voltage</b>	230~50Hz
<b>Power consumption</b>	30W
<b>Light colour options</b>	Daylight
<b>Colour temperature</b>	5000K
<b>Beam angle</b>	120°
<b>Dimmable</b>	No
<b>IP Rating</b>	IP44
<b>Detection range</b>	12m (at 1.8m mounting height)
<b>Duration time adjustment</b>	10±5 seconds to 4± minutes
<b>Detection circuitry</b>	Passive infra - red (PIR)

### Product range

Code	Description
<b>AT9819/30/BLK/S</b> SKU: 12397	30W Slim Floodlight - Black with Sensor - 2590lm
<b>AT9819/30/WH/S</b> SKU: 11888	30W Slim Floodlight - White with Sensor - 2590lm

### Finish

■ Black □ White

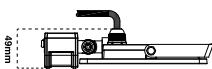
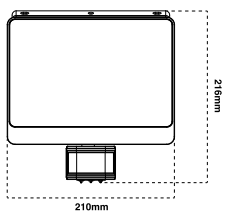

# atom

## AT9819/50

50W LED Slim Floodlight

### Product specification

<b>Voltage</b>	230~50Hz
<b>Power consumption</b>	50W
<b>Light colour options</b>	Daylight
<b>Colour temperature</b>	5000K
<b>Beam angle</b>	120°
<b>Dimmable</b>	No
<b>IP Rating</b>	IP65

### Product range

Code	Description
AT9819/50/BLK SKU: 12468	50W Slim Floodlight - IP65 - Black - 4000lm
AT9819/50/WH SKU: 11982	50W Slim Floodlight - IP65 - White - 4000lm



### Finish

■ Black □ White

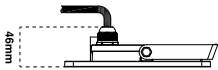
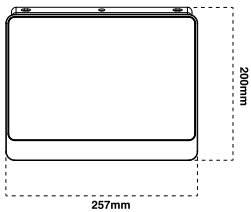

### Finish

■ Black □ White

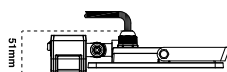
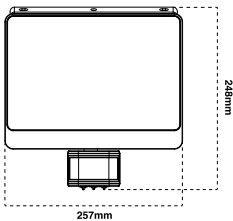

## AT9819/50/S

50W LED Slim Floodlight with sensor

### Product specification

<b>Voltage</b>	230~50Hz
<b>Power consumption</b>	50W
<b>Light colour options</b>	Daylight
<b>Colour temperature</b>	5000K
<b>Beam angle</b>	120°
<b>Dimmable</b>	No
<b>IP Rating</b>	IP44
<b>Detection range</b>	12m (at 1.8m mounting height)
<b>Duration time adjustment</b>	10±5 seconds to 4± minutes
<b>Detection circuitry</b>	Passive infra - red (PIR)

### Product range

Code	Description
AT9819/50/BLK/S SKU: 11394	50W Slim Floodlight - Black with Sensor - 4255lm
AT9819/50/WH/S SKU: 11455	50W Slim Floodlight - White with Sensor 4255lm



## AT9828

120W IP65 LED Highbay

### Product specification

<b>Voltage</b>	230~50Hz
<b>Power consumption</b>	120W
<b>Light colour options</b>	Daylight
<b>Colour temperature</b>	5000K
<b>Beam angle</b>	120°
<b>Dimmable</b>	No
<b>IP Rating</b>	IP65

### Product range

Code	Description
AT9828/120 SKU: 10409	120W LED Highbay - 18000lm



### Finish

■ Black

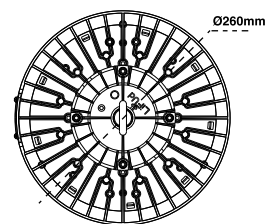
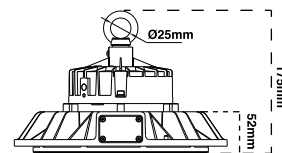



## HOVER

120W, 150W & 200W IP65 LED Highbays

### Product specification

<b>Voltage</b>	230~50Hz
<b>Power consumption</b>	120W, 150W & 200W
<b>Light colour options</b>	Daylight
<b>Colour temperature</b>	5000K
<b>Beam angle</b>	120°
<b>Dimmable</b>	No
<b>IP Rating</b>	IP65

### Product range

Code	Description
<b>HOVER</b> SKU: 16022	120W LED Highbay - 5000K - 120° - Black - 16800lm
<b>HOVER</b> SKU: 16023	150W LED Highbay - 5000K - 120° - Black - 21000lm
<b>HOVER</b> SKU: 16024	200W LED Highbay - 5000K - 120° - Black - 28000lm



### Finish

■ Black

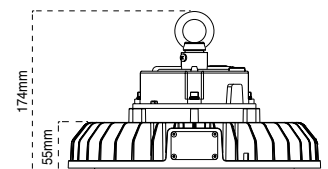
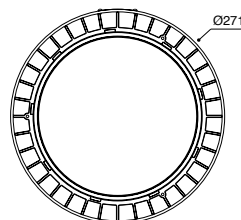
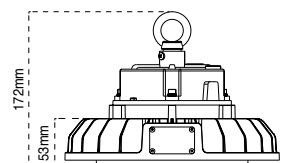
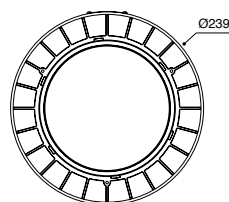



## AT9890, AT9891 & AT9895

600mm & 1200mm IP65 Weatherproof LED Battens

### Product specification

<b>Voltage</b>	230~50Hz
<b>Power consumption</b>	12W & 24W
<b>Light colour options</b>	Cool white
<b>Colour temperature</b>	4000K
<b>Strips</b>	Single & Twin
<b>Dimmable</b>	No
<b>Beam angle</b>	120°
<b>IP Rating</b>	IP65
<b>IK Rating</b>	IK08
<b>Average rated life</b>	L70 (9K) > 54,000 Hrs

### Product range

Code	Description
<b>AT9890</b> SKU: 11638	12W Single 600mm IP65 Weatherproof LED Batten - 1140lm
<b>AT9895</b> SKU: 11398	24W Single 1200mm IP65 Weatherproof LED Batten - 2270lm
<b>AT9891</b> SKU: 11186	24W Twin 600mm IP65 Weatherproof LED Batten - 2365lm



### Finish

■ Grey

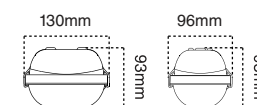
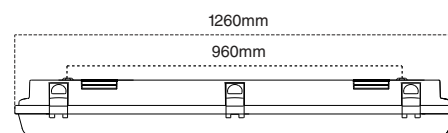
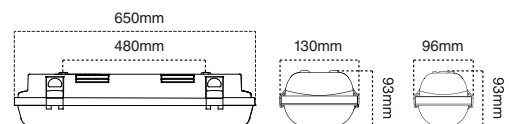



## AT9873 & AT9877

600mm & 1200mm IP65 Weatherproof Basic LED Battens

### Product specification

<b>Voltage</b>	230~50Hz
<b>Power consumption</b>	28W & 48W
<b>Light colour options</b>	Cool white
<b>Colour temperature</b>	4000K
<b>Strips</b>	Twin
<b>Dimmable</b>	No
<b>Beam angle</b>	120°
<b>IP Rating</b>	IP65
<b>IK Rating</b>	IK08
<b>Average rated life</b>	L70 (10K) 58,000 Hrs

### Product range

Code	Description
<b>AT9873</b> SKU: 11329	28W Twin 600mm IP65 Weatherproof Basic LED - 2685lm
<b>AT9877</b> SKU: 11615	48W Twin 1200mm IP65 Weatherproof Basic LED - 4860lm

### Finish

■ Grey

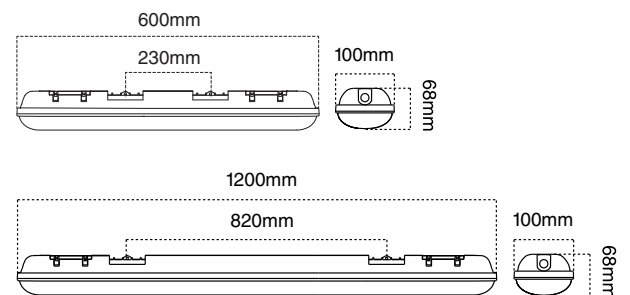



## SPEAR

20W & 40W Narrow Body LED Batten - Tri-CCT

### Product specification

<b>Voltage</b>	230~50Hz
<b>Power consumption</b>	21W & 42W
<b>Light colour options</b>	Tri Colour
<b>Colour temperature</b>	3000K, 4000K & 5700K
<b>Strips</b>	Single
<b>Dimmable</b>	No
<b>Beam angle</b>	120°
<b>IP Rating</b>	IP20
<b>IK Rating</b>	IK08
<b>Average rated life</b>	L70 (9K) > 54,000 Hrs

### Product range

Code	Description
<b>SPEAR</b> SKU: 16054	20W 600mm Narrow Body LED Batten - Tri Colour - White - 2069lm
<b>SPEAR</b> SKU: 16055	40W 1200mm Narrow Body LED Batten - Tri Colour - White - 4490lm



### Finish

White

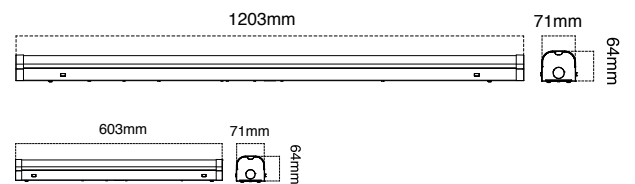



## AT9842, AT9864, AT9865 & AT9866

21W & 42W Narrow and Wide Body Opal Diffused LED Battens

### Product specification

<b>Voltage</b>	230~50Hz
<b>Power consumption</b>	21W & 42W
<b>Light colour options</b>	Cool white
<b>Colour temperature</b>	4000K
<b>Strips</b>	Single & Twin
<b>Dimmable</b>	No
<b>Beam angle</b>	120°C
<b>IP Rating</b>	IP20
<b>Average rated life</b>	L70 (9K) > 54,000 Hrs

### Product range

Code	Description
<b>AT9842/CW/O</b> SKU: 11254	21W Single 1200mm Narrow Body Opal Diffused LED Batten - 2250lm
<b>AT9864/CW/O</b> SKU: 13203	21W Twin 600mm Wide Body Opal Diffused LED Batten - 2275lm
<b>AT9865/CW/O</b> SKU: 11145	21W Single 1200mm Narrow Body Opal Diffused LED Batten - 2275lm
<b>AT9866/CW/O</b> SKU: 11135	42W Twin 1200mm Wide Body Opal Diffused LED Batten - 4865lm



### Finish

White

### Accessories

#### AT9865/66/DIFF - O

SKU: 11913

Opal Diffuser only - 1200mm - Wide body.  
Suitable for AT9865 and AT9866 Battens

#### AT9865/66/DIFF - P

SKU: 11362

Prismatic Diffuser only - 1200mm - Wide body.  
Suitable for AT9865 and AT9866 Battens

For full product list see pages 119 - 120

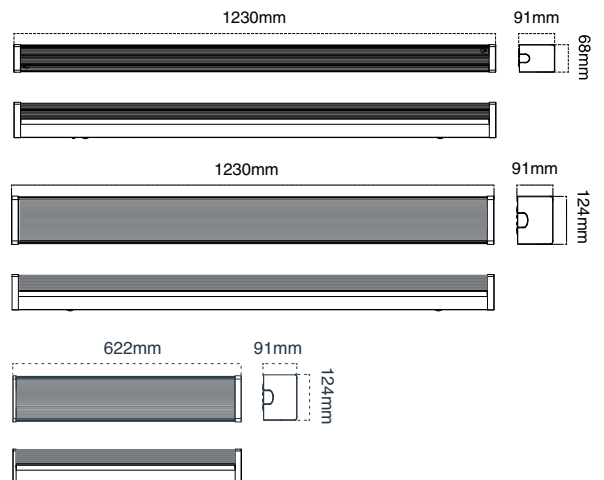





## AT9884, AT9885 & AT9886

21W & 42W Single and Twin Wide Body Wire Guard LED Batten

### Product specification

<b>Voltage</b>	230~50Hz
<b>Power consumption</b>	21W & 42W
<b>Light colour options</b>	Cool white
<b>Colour temperature</b>	4000K
<b>Strips</b>	Single & Twin
<b>Dimmable</b>	No
<b>Beam angle</b>	120°C
<b>IP Rating</b>	IP20
<b>Average rated life</b>	L70 (9K) > 54,000 Hrs

### Product range

Code	Description
<b>AT9884/CW</b> SKU: 13954	21W Twin 600mm Wide Body Wire Guard LED Batten - 1795lm
<b>AT9885/CW</b> SKU: 14058	21W Single 1200mm Wide Body Wire Guard LED Batten - 1850lm
<b>AT9886/CW</b> SKU: 12135	42W Twin 1200mm Wide Body Wire Guard LED Batten - 3645lm



### Finish

White

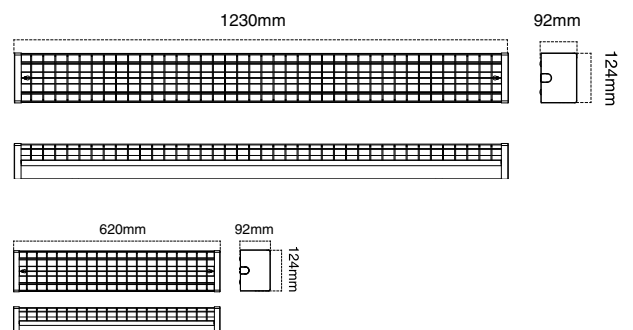

## PANELS



**AT9050/PRF/WH**  
SKU 10398  
Plaster recessed frame 300 x 1200mm White.  
Suitable for AT6020 & AT6021



**AT9050/SMF/WH**  
SKU 11212  
Surface mounted frame 300 x 1200mm White.  
Suitable for AT6020 & AT6021



**AT9051/PRF/WH**  
SKU 10760  
Plaster recessed frame 600 x 600mm White.  
Suitable for AT6020 & AT6021



**AT9051/SMF/WH**  
SKU 11471  
Surface mounted frame 600 x 600mm White.  
Suitable for AT6020 & AT6021



**AT9053/PRF/WH**  
SKU 10258  
Plaster recessed frame 300 x 600mm White.  
Suitable for AT6020 & AT6021



**AT9053/SMF/WH**  
SKU 11772  
Surface mounted frame 300 x 600mm White.  
Suitable for AT6020 & AT6021



**AT9056/PRF/WH**  
SKU 13856  
Plaster recessed frame 300 x 1200mm White.  
Suitable for AT6020 & AT6021



**AT9056/SMF/WH**  
SKU 13673  
Surface mounted frame 300 x 1200mm White.  
Suitable for AT6020 & AT6021



**AT9057**  
SKU 11315  
Panel Suspension Cable Kit.  
Suitable for AT6020 & AT6021

## BATTENS



**AT9842/DIFF-P**  
SKU 12542  
Prismatic Diffuser only - 1200mm - Narrow body.  
Suitable for AT9842

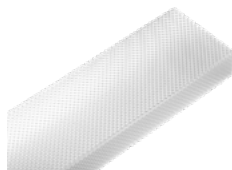

**AT9865/66/DIFF - P**  
SKU 11362  
Prismatic diffuser only - 1200mm - Wide body.  
Suitable for AT9865 & AT9866



**AT9864/DIFF-P**  
SKU 11317  
Prismatic Diffuser only - 600mm - Wide body.  
Suitable for AT9864

FLOODLIGHT



**AT9865/66/DIFF - O**

SKU 11913  
Opal diffuser only - 1200mm - Wide body.  
Suitable for AT9865 & AT9866



**AT9812/PMB**

SKU 12207  
Pole mounting bracket.  
Suitable for AT9814

HIGHBAYS



**AT9827/29/LENS/50**

SKU 10963  
50° Lens for AT9827/AT9829.  
Suitable for AT9827 & AT9829



**AT9827/29/REF/BLK**

SKU 10917  
90° Lens for AT9827/AT9829.  
Suitable for AT9827 & AT9829

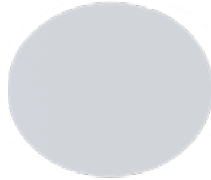

**AT9812/PMB**

SKU 12207  
Opal Lens for AT9827/AT9829.  
Suitable for AT9827 & AT9829



**AT9827/29/REF/BLK**

SKU 10917  
90° Reflector for AT9827/AT9829 - Black.  
Suitable for AT9827 & AT9829



**Drivers and  
Accessories**

# Overview

## DRIVERS AND ACCESSORIES

- WEATHERPROOF DRIVERS 126
- CONSTANT VOLTAGE DRIVERS 126
- VOLTAGE DRIVERS 127
- CONSTANT CURRENT DRIVERS 127
- DIMMERS 128



## WEATHERPROOF



### AT030va W/P

SKU 10321  
30Va Dimmable Weatherproof Transformer  
30W - IP67 - Iron core  
Dimensions: 65 x 140mm



### AT050va W/P

SKU 10445  
50Va Dimmable Weatherproof Transformer  
50W - IP67 - Iron cor.  
Dimensions: 70 x 185mm



### AT060va W/P

SKU 10665  
60Va Mini Weatherproof Transformer  
60W - IP64 - Iron core  
Dimensions: 70 x 135mm



### AT100va W/P

SKU 10573  
100Va Dimmable Weatherproof Transformer  
100W - IP67 - Iron core  
Dimensions: 70 x 175mm



### AT105va W/P

SKU 10680  
105Va Mini Weatherproof Transformer  
105W - IP64 - Iron core  
Dimensions: 70 x 180mm



### AT200va W/P

SKU 10575  
200Va Dimmable Weatherproof Transformer  
200W - IP67 - Iron core  
Dimensions: 100 x 200mm



### AT300va W/P

SKU 10824  
300Va Dimmable Weatherproof Transformer  
300W - IP67 - Iron core  
Dimensions: 100 x 200mm



### AT400va W/P

SKU 10722  
400Va Dimmable Weatherproof Transformer  
400W - IP67 - Iron core  
Dimensions: 110 x 230mm



### AT500va W/P

SKU 10381  
500Va Dimmable Weatherproof Transformer  
500W - IP67 - Iron core  
Dimensions: 110 x 230mm

## CONSTANT VOLTAGE



### AT9643/20

SKU 11337  
20W 24V d.c. Constant voltage non - dimmable driver with Flex & Plug  
Dimensions: 107 x 41 x 22mm



### AT9643/60

SKU 11370  
60W 24V d.c. Constant voltage non - dimmable driver with Flex & Plug  
Dimensions: 170 x 50 x 29mm



### AT9644/60

SKU 11370  
60W 24V d.c. Constant voltage Dimmable driver with Flex & Plug  
Dimensions: 170 x 50 x 29mm

## VOLTAGE DRIVERS



**AT9601**  
SKU 10147  
LED DC 6W Driver  
Dimensions: 103 x 38 x 25mm



**AT9602**  
SKU 10174  
LED DC 10W Driver  
Dimensions: 128 x 38 x 25mm



**AT9603**  
SKU 10259  
LED DC Dimmable 10W Driver  
Dimensions: 112 x 38 x 25mm



**AT9604**  
SKU 10230  
LED DC 12V 20W Driver  
Dimensions: 155 x 38 x 25mm



**AT9605**  
SKU 10762  
LED DC Dimmable 20W Driver  
Dimensions: 128 x 35 x 25mm



**AT9606**  
SKU 10783  
LED DC 50W Driver  
Dimensions: 175 x 46 x 35mm

## CONSTANT CURRENT



**AT9620**  
SKU 10154  
LED 1 - 6W 350mA Constant Current Driver  
Dimensions: 103 x 38 x 25mm



**AT9621**  
SKU 10201  
LED 6W - 700mA Constant Current Driver  
Dimensions: 103 x 38 x 25mm



**AT9628**  
SKU 10784  
18W - 700mA Constant Current Dimmable LED Driver  
Dimensions: 103 x 38 x 25mm

## DIMMER



**AT0972**  
SKU 10974  
12W - 350mA Constant Current Dimmable LED Driver  
Dimensions: 103 x 38 x 25mm



**AT9303**  
SKU 11272  
350W Trailing control Dimmer - Push button.  
Dimensions: 23.5 x 44.3 x 23.5mm



## WARRANTY

Atom products are distributed in Australia by Evolt Pty Limited ('us', 'our', or 'we'). Our contact information is shown on this catalogue.

As a responsible supplier, our goods come with guarantees that are covered under the Australian Consumer Law. You are entitled to a replacement or refund for a major failure and compensation for any other reasonably foreseeable loss or damage. You are also entitled to have the goods repaired or replaced if the goods fail to be of acceptable quality and the failure does not amount to a major failure.

In addition to your guarantees under the Australian Consumer Law, our goods also come with a contractual warranty, which is described below. This warranty is additional to your rights under the Australian Consumer Law (and any other rights or remedies you may have under a law in relation to the products) and is not intended to modify or exclude those rights.

Subject to the terms of this contractual warranty, if your Atom products are defective, we will (at our election) repair or replace the Atom products. Once we make this election (and take the relevant action), we will have honored our obligations under this contractual warranty.

Our total liability under this warranty is limited to the cost of repair or replacement of the defective product (at our election). We otherwise exclude all liability in relation to the product to the fullest extent permitted by law (noting our comments above regarding the Australian Consumer Law and any other rights or remedies you may have).

If you wish to claim under this warranty, you must, at your own expense, return the product or that part of the product which you believe is defective, together with proof of original purchase, your name, address and telephone number and a certificate of installation (or other document required by the law for the installation of electrical products in the place in which the product was installed) to Evolt at the address set out on this catalogue, within the warranty period. You bear all costs associated with claiming under this warranty (including, but not limited to, postage costs).

Without limiting the preceding sentence, this warranty does not apply to the costs of the removal or re-installation of the defective product.

The warranty period for this product is three years from the date of purchase. This warranty is not transferable and is only given to the original purchaser of the product, provided the purchaser has purchased the product from us. Proof of purchase must be provided to us with any warranty claim. We recommend that you attach your proof of purchase to your product manual.

This warranty does not apply to consumable items within your product (including, but not limited to, lamps or batteries). This warranty does not apply to products that have been improperly stored, installed, or used. This warranty does not apply to products that have not been maintained in accordance with the instructions contained within this product manual.

This warranty does not apply to loss or damage caused by wear and tear, misuse, incorrect installation or operation, failure to clean and maintain, incorrect voltage or non-authorized electrical connections, adverse external conditions (such as power surges and dips, acts of God, exposure to heat, corrosion, insect or vermin infestation), use of non-authorized or defective parts or globes, or to items that have been repaired than by a person other than us or a repairer approved by us.



## TERMS & CONDITIONS OF SALE

Unless otherwise agreed to in writing, all goods (“Goods”) sold or offered for sale by Evolt Pty. Ltd ACN 112 123 529 ABN 83 112 123 529 (hereinafter referred to as “Evolt”) are done so subject to the following conditions:

### PRICES

#### PRICES:

All prices are quoted excluding GST, and any GST applicable will be charged to the Buyer on a Tax Invoice (as defined in the GST Act).

#### QUOTATIONS:

Quotation pricing is valid for three (3) months.

### DELIVERY

Late delivery or non-delivery due to any circumstances or events beyond Evolt’s control shall not constitute a breach of contract by Evolt and Evolt shall not be liable for any loss or damage howsoever arising through such late delivery or non-delivery. The choice of the carrier and method of transport remains with Evolt, unless transport is paid for by the Buyer.

### WARRANTIES

#### THE WARRANTIES:

Subject to paragraphs 4 and 5, unless otherwise agreed between the parties in writing, Goods manufactured, or sold, by Evolt under any of its’ Brand Names, are warranted against faulty materials and/or workmanship for (1) one year from date of delivery.

### CONDITIONS OF WARRANTY

The warranties set out in paragraph 3 are subject to compliance with the following conditions:

Goods must be used and handled with due care, under normal operating conditions and in accordance with the Relevant Standards and good practices.

Goods must be mounted, installed and connected with due care and in accordance with the Relevant Standards and good practices.

Goods must be returned to Evolt’s local office within 14 days of the detection of the alleged fault in their then current condition. Wilfully damaged or defaced Goods are excluded from this warranty.

Evolt reserves the right to request that the complete piece of equipment containing the allegedly faulty component be returned to Evolt for inspection and testing.

In the case of any dispute under this warranty, Evolt reserves the right to obtain the opinion of a suitably qualified independent expert whose opinion as to any question of fact under this warranty shall be binding on the parties.

### LIMITATION OF LIABILITY

Evolt will not be liable for any loss or damage incurred by the Buyer or End User for Goods damaged as a result of negligence, alteration, accident, use of the Goods in a way which is not in compliance with the Relevant Standards or use of the Goods in any way for which the Goods were not designed or approved by Evolt or as a result of improper fitting, repair or replacement.

The liability of Evolt in respect of faulty materials or workmanship shall, at the option of Evolt, be limited to one of the following:

- the replacement of the Goods;
- the supply of equivalent Goods;
- the repair of the Goods; or
- the payment of the cost of having the Goods repaired.

Evolt will not be liable for any special indirect or consequential damage arising out of the supply of the Goods.

If a claim is made by a Buyer or End User under one of the warranties set out in paragraph 4, Evolt will not accept any claim for costs, charges or expenses incurred by the Buyer or End User in relation to replacement, supply or repair of the Goods.

Except for any warranties and conditions which cannot be excluded under any Act, all warranties and conditions with regard to the Goods sold which are implied by common law, statute or trade usage are excluded to the full extent legally permissible.

### PAYMENTS

Unless otherwise agreed to in writing, all invoices are net payable thirty (30) days following the month of delivery to Evolt’s head office. All payments received by Evolt must, in all cases, be allocated to the oldest account due for payment.

### RETURN OF GOODS

Goods will not be accepted for return without prior written consent from Evolt. Goods manufactured to Buyer’s requirements and/or specification cannot be returned for credit. Please see attachment for more details.

### LOCATION OF CONTRACT (LEGAL DOMICILE)

Any contract with Evolt shall be deemed to have been executed and entered into in the State of New South Wales, Australia and the same shall be construed enforced and performed in accordance with the laws thereof. Any proceedings shall be brought and heard in the courts of the State of New South Wales.

## TITLE AND RISK

Evolt supplies Goods on condition that, property in the Goods does not pass to the Buyer until they have been paid in full and Evolt has been paid for all other moneys then owing to Evolt by the Buyer.

notwithstanding paragraph 11.1, the Goods are at the risk of the Buyer as soon as they have been delivered to or into the custody of the Buyer or the Buyer's agent.

until property in the Goods passes to the Buyer under paragraph 11.1, the Goods are merely entrusted to the Buyer as fiduciary and Evolt remains the legal and beneficial owner of the Goods with full power to re-sell and regain possession of them if the Buyer defaults in payment of the purchase price.

if the Buyer defaults in payment of the purchase price or if the Buyer becomes insolvent, Evolt and/or its authorised agents may at any time without notice to the Buyer enter onto the Buyer's premises and any other premises at which the Goods are situated including but not limited to the Buyers premises or the End Users Premises for the purpose of recovering possession of them. The Buyer agrees to indemnify the Seller against all costs, losses and expenses (including without limitation legal costs) incurred by the Seller as a result of or in connection with any default or breach of these Terms and Conditions of Sale by the Buyer.

if the Buyer receives any proceeds from the sale of the Goods from any other party, the Buyer receives those proceeds on trust for Evolt to be applied in payment of the purchase price for the Goods and shall remit such sum forthwith to Evolt. All such payments received by Evolt shall be allocated to the oldest account due for payment.

## CONFLICT WITH BUYER'S TERMS

If any purchase order or other trading terms of the Buyer conflict with or are inconsistent with any of Evolt's terms and conditions of sale, then Evolt's terms and conditions of sale as amended from time to time prevail and will apply notwithstanding any conflicting or inconsistent terms of the Buyer. The Buyer acknowledges that the sale by Evolt of any Goods will not constitute acceptance of any conditions of purchase of the Buyer which conflict or are inconsistent with any of Evolt's terms and conditions of sale, even where Evolt acknowledges the Buyer's conditions prior to, upon or by delivery of Goods.

## NON-WAIVER

A waiver by Evolt with respect to any breach or default by the Buyer shall not constitute a continuing waiver of any other breach or default or of any other right or remedy. A failure or delay by Evolt in exercising a right or remedy does not operate as a waiver of that right or remedy

## VARIATION

A variation of these Terms and Conditions of Sale shall be ineffective unless it is in writing and signed by Evolt.

## SEVERABILITY

If a Court determines that a condition or part of these conditions is unenforceable, illegal or void then it shall be severed and the remainder of these Terms and Conditions of Sale shall remain operative.

## DEFINITIONS

In these Terms and Conditions of Sale the following terms shall have the following meanings:

**"Brand Names"** means "Evolt", "Ektor"; "Atom", **"WiZ"**.

**"Buyer"** means the buyer of the Goods;

**"End User"** means a person or business which purchases or uses Goods supplied directly or indirectly by the Buyer;

**"Goods and Services Tax"** or **"GST"** has the same meaning as given in the GST Act;

**"GST Act"** means the A New Tax System (Goods and Services Tax) Act 1999 (Commonwealth);

**"Relevant Standards"** means the relevant International Organisation for Standardisation ("ISO") standard and the relevant International Electro technical Commission ("IEC") standard applicable to the Goods.

## ACKNOWLEDGMENT & INDEMNITY

The Buyer shall, in every instance where the Goods are being purchased from Evolt for an End User or the Goods are on sold to an End User,;

ensure either by inclusion into any contract between the Buyer and the End User or otherwise that the End User is aware of and agrees to these Terms and Conditions upon which Evolt supplies the Goods, and

indemnifies and agrees to keep indemnified Evolt from all claims, demands, suits and liabilities whatsoever and howsoever arising whether in tort or in contract that may be made by End Users regarding the Goods.





evolt

[sales@evolt.com.au](mailto:sales@evolt.com.au)

PO Box 271

Kingsgrove NSW 1480

[evolt.com.au](http://evolt.com.au)