

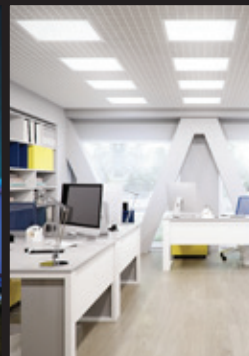

# Trade Catalogue 2020



**AUSTRALIA**

# Brilliant

## Trade Catalogue

Be certain in your lighting choices, with outstanding support, reliable and easy-to-use solutions from Brilliant Lighting.

Brilliant lighting is an industry leader with over 30 years' experience in lighting, electrical, air movement and smart products. We offer solutions for residential, commercial and architectural markets, through retail, DIY and trade channels in Australia and New Zealand.

We are committed to providing efficient and sustainable lighting. Our mission is to reduce our carbon footprint and increase sustainability throughout every aspect of our business.

Our customers are at the forefront of what we do and we have a wide range to suit all of your requirements. Our commitment is to produce quality lighting and smart products that you can be confident in.

### **Brilliant Lighting**

956 Stud Road  
Rowville VIC 3178 Australia

[www.brilliantlighting.com.au](http://www.brilliantlighting.com.au)

# Contents

BRILLIANTSMART	5
COMMERCIAL	55
ELECTRICAL	77
EMERGENCY	89
CEILING FANS	103
BATHROOM	141
EXTERIOR	183
SECURITY	213
SENSORS	225
GARDEN	239
CEILING & WALL	257
DOWNLIGHT	271
STRIP LIGHTING	285
GLOBES	291
TASK, TABLE & FLOOR LAMPS	315
PENDANTS	333

Please note: all measurements are millimetres (mm) unless otherwise stated.



 **WiFi**  
NO HUB REQUIRED

 WORKS WITH  
**alexa**

**Voice control**

 works with the  
**Google Assistant**

Works with  
**IFTTT**

Powered by  
**tuya**  
Intelligence  
Inside



# BrilliantSmart

Take control with our range of smart WiFi products to control your appliances and lights by voice, app or manually

# Unlock the BrilliantSmart Home!

BrilliantSmart coordinates the technology in your life into a complete smart home solution, adding convenience and luxury to your lifestyle.

## Connects most elements of your home from one app

With one touch you can dim the lights, adjust the temperature, arm security, automate appliances and more.

Or have your house respond to your schedule and needs, without touching anything at all.

Not only connects with BrilliantSmart products, but also works with most plug-in appliances and other smart devices.

The control is either manually by switch, via the app, or voice activated using Google Home® or Amazon Alexa®.



## Customisable solutions to suit your changing needs

Automate lighting and appliances on a schedule and save energy by reducing consumption and monitoring power usage.

Create ambiance using mood and scene settings.

Create rules using 'If This Then That' (IFTTT) type logic – link devices in your home to specific behaviour, ie: if movement is detected in the lounge room, have the lights turn on or sound the siren.

It's scalable, so you can build your smart home at your own pace and customise it as your needs change.

### Simple & Affordable

The BrilliantSmart app connects to your existing WiFi home router.

No Hub required.

Simply download the FREE BrilliantSmart App onto your mobile device to create the control.

The App can be used anywhere as long as there is an internet connection.

### Secure

Data encryption ensures safety of data transmission.

**Now that's a Brilliant way to live!**



## Control your home from your phone, voice control or manually

BrilliantSmart allows you to control lighting, appliances, security, temperature, video playback, energy management plus much more... All from ONE simple app on your Smartphone or tablet.

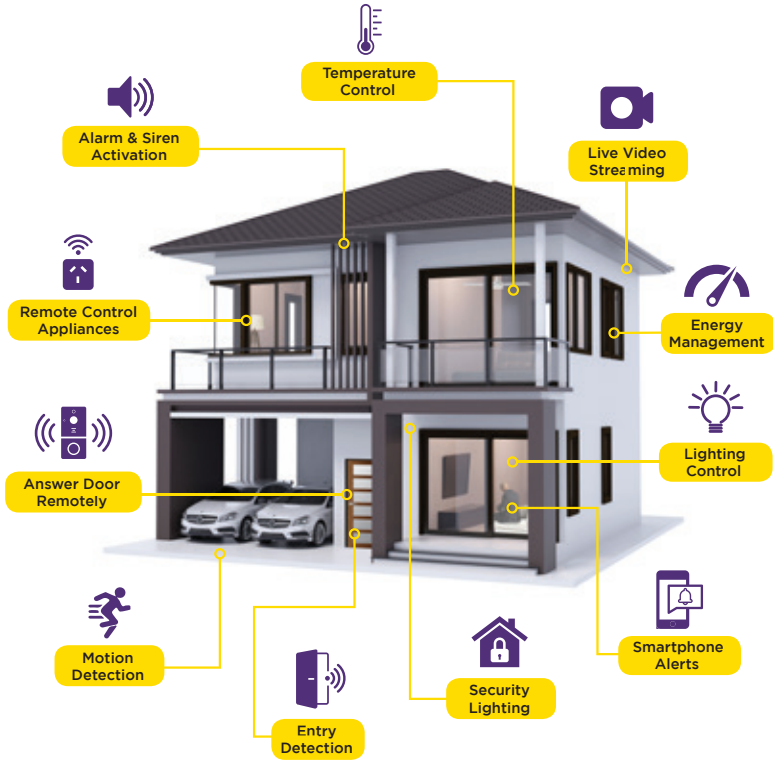

### Limitations of WiFi network

The amount of devices you can connect directly to your WiFi network is limited by the particular WiFi router you have and its maximum allowable amount of connected devices. You may need to upgrade your router or install Access Points (APs).

### Smart Security Products

The BrilliantSmart security products are designed for easy connection to each other to enable you to create your own security network. Simply use the Sequence & Automation function to automate your smart sensor, reed switch or even the camera so they activate the smart siren when triggered.

### Sequences in general

You can also connect most of the range of BrilliantSmart products to each other. For instance, by using the Sequence & Automation function in the BrilliantSmart app you can automate your Smart downlights to turn on if your Smart sensor detects movement, your garden lights to turn on when your camera detects movement etc.

Technical specifications for all BrilliantSmart devices:

- Security: Mac Encryption; WEP/WAPI/TKIP/AES
- WiFi Standard: IEEE802.11b/g/n, 2.4 GHz
- System Req's: iOS 8.0 or higher, Android 4.1 or higher

All measurements are millimetres (mm) unless otherwise stated.



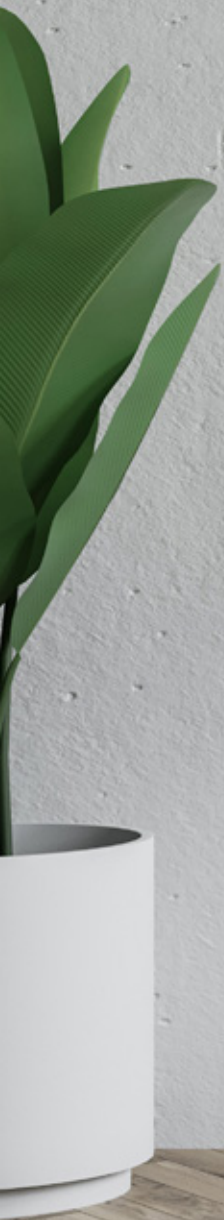





# HOME AUTOMATION & ELECTRICAL

Allows you to automate and control your  
home from anywhere and customise  
to suit your needs

# DIMMER MECH

## TRAILING EDGE DIMMER

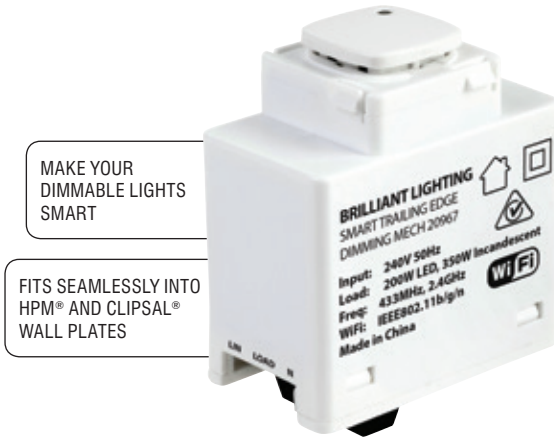



**ELECTRICIAN**

**2W**

MIN LOAD

**350W**

MAX LOAD



**DIMMING**

**3 WIRE**

REQUIRES NEUTRAL

**1YR**

WARRANTY

Make existing dimmable downlights smart with the BrilliantSmart Dimmer Mech. Enables both dimming and on/off control via app, voice control or manually.

- The compact dimmer mech fits conveniently into your existing light switch plate.
- Perfect for new or retro-fit installations.
- It has a trailing edge dimming design, so it works effectively with most LED dimmable lighting products.
- Programmable minimum brightness level to avoid light flickering.
- Overheat and over-current protection.
- Slots seamlessly into HPM® and Clipsal® branded wall plates.
- Soft start for improved lamp life.
- Build schedules and timing to automate your home.
- Create virtual automation looping without the hassle of installing long cable runs.
- Compatible with BrilliantSmart devices via automation & IFTTT.

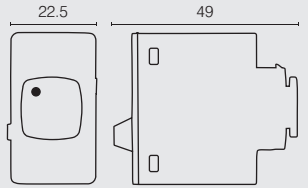

MODEL NO.	DESCRIPTION
20967	ON/OFF/DIM



Voice control

**WIFI**  
NO HUB REQUIRED

works with alexa

works with the Google Assistant

Works with IFTTT

# RELAY MECH SWITCH

SMART WIFI ON/OFF

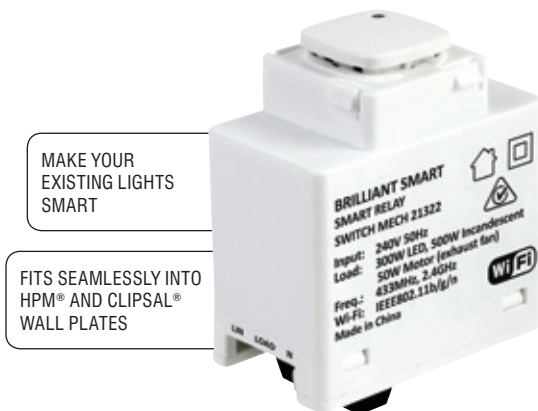

**2W**  
MIN LOAD

**500W**  
MAX LOAD

**3 WIRE**  
REQUIRES  
NEUTRAL

**1YR**  
WARRANTY

## Smartify your on/off switch to allow remote operation from anywhere.

- Make your on/off switch or exhaust fan smart by converting your current switch to our Smart relay module
- Fits conveniently into the existing switch plate
- Perfect for new or retro-fit installations
- Slots seamlessly into HPM®, Clipsal® and Vynco® branded wall plates
- Control from anywhere via app or voice control
- Build schedules and timing to automate your home
- Create virtual automation looping without the hassle of installing long cable runs\*
- Soft start for improved lamp life
- Connects to other BrilliantSmart devices and other compatible products
- Overheat and over-current protection
- Manual push button is in perfect sync with app

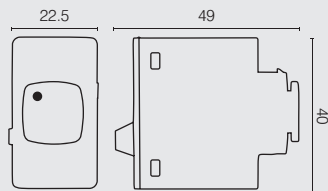

MODEL NO.	DESCRIPTION
21322	ON/OFF (NON-DIM)



Voice control

WIFI  
NO HUB REQUIRED

WORKS WITH  
ALEXA

works with the  
Google Assistant

Works with  
IFTTT

# DIMMER CONTROLLER

## JUPITER LEADING EDGE DIMMER WITH RF



**100W**  
MAX LOAD

**DIMMING**

**1YR**  
WARRANTY

Make your existing dimmable lighting smart with this leading edge dimming module, allowing you to control your lights anywhere by either voice, app or manually using a wall switch.

- Fits through a hole as small as Ø53mm, perfect for new or retro-fit installations.
- Overheat and over-current protection.
- Maximum load capacity 100W.
- Minimum load capacity 5W.
- Automatic soft start mode to improve lamp life.
- Create schedules and timing to automate your home.
- Pair with our Kinetic switch to deliver wireless switching option to your lighting.
- Compatible with BrilliantSmart devices via automation & IFTTT.

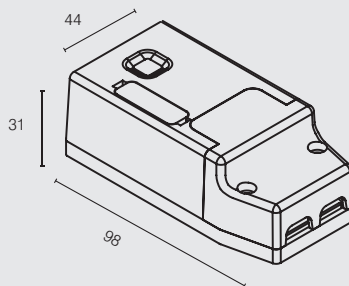

MODEL NO.	COLOUR
20693/05	White



Voice control

WIFI  
NO HUB REQUIRED

WORKS WITH  
ALEXA

works with the  
Google Assistant

Works with  
IFTTT

# REMOTE SWITCH

## KINETIC RF DIMMER SWITCHES



This innovative smart switch allows you to control the lights in your home with the push of a button. The kinetic switches are wireless so you can place the controls exactly where you want them.

- Completely portable and easy to set up, this nifty home accessory will optimise your smart lighting system.
- Uses kinetic energy and is powered by your touch so no batteries or wiring needed.
- Fully portable for use as a remote, or can be mounted to the wall for easy storage.
- With up to three configurable buttons, you can utilise one switch to control multiple rooms or lights.
- Control distance: up to 20m indoor using RF 433MHz multiple way control.

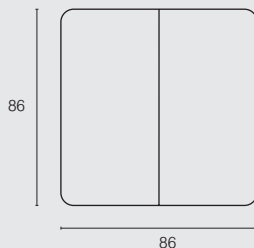

**ONLY WORKS IN CONJUNCTION WITH JUPITER SMART WIFI/RF DIMMER CONTROLLER**

MODEL NO.	COLOUR	DESCRIPTION
20758/05	White	1 Gang
20759/05	White	2 Gang
20760/05	White	3 Gang

# RELAY CONTROLLER

FOX ON/OFF SWITCH



Make your existing lighting or switches smart with this relay connector, allowing you to control them anywhere by either voice, app or manually using a wall switch.

- Fits through a hole as small as Ø56mm making them perfect for new or retro-fit installations.
- Overheat and over-current protection.
- Maximum load capacities:
  - 500W (LED)
  - 2400W (Incandescent)
- Set virtual automation looping without the hassle of installing long cable runs.
- Create schedules and timing to automate your home.
- Compatible with BrilliantSmart devices via automation & IFTTT.

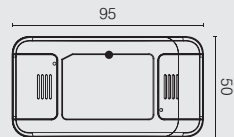

MODEL NO.	COLOUR
20694/05	White



Voice control

WIFI  
NO HUB REQUIRED

WORKS WITH  
ALEXA

WORKS WITH  
GOOGLE ASSISTANT

WORKS WITH  
IFTTT

# WALL SWITCH

ELITE GLASS RANGE

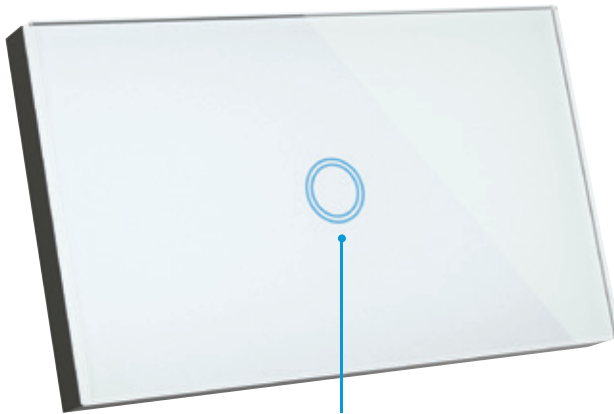

Blue 'On'



Smart wall switches allow you to control lighting, and appliances anywhere by either voice, app or manually by the switch. The Elite wall switch is made from durable, mark-resistant tempered glass to keep your switches looking like new for years to come.

- Perfect for new or retro-fit installations.
- Touch sensitive buttons incorporate multi-way on/off switching with a easy to see blue LED indicator that shows which switch is in use, diminishing to a subtle glow when off.
- Built-in power monitoring feature allows you to measure energy use of connected lights and appliances.
- Automatic soft start mode to improve lamp life.
- Set virtual automation looping without the hassle of installing long cable runs.
- Maximum load capacities per gang 150W (LED), 500W (Incandescent).
- Overheat and over-current protection.
- Big bore 20mm<sup>2</sup> terminals suitable for 2.5mm cables, requires neutral to operate (3-wire design).
- Fits standard plaster/stud brackets (84mm centres).
- Create schedules and timing to automate your home.
- Compatible with BrilliantSmart devices via automation & IFTTT.

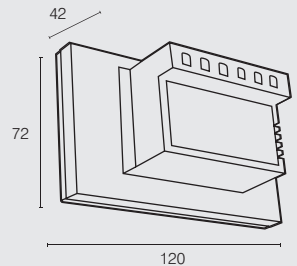

MODEL NO.	COLOUR	DESCRIPTION
20681/05	White	1 Gang
20683/05	White	2 Gang
20685/05	White	3 Gang
20687/05	White	4 Gang



Voice control

WIFI NO HUB REQUIRED

WORKS WITH alexa

works with the Google Assistant

Works with IFTTT

# GARAGE DOOR OPENER

SUITS TILT & SECTIONAL GARAGE DOORS



Please check that your existing door motor/controller has manual override terminals.

This may be found behind access panels on your existing garage door motor/controller.

If you momentarily connect these two terminals together (with a wire) and it activates the door then this product will be compatible.

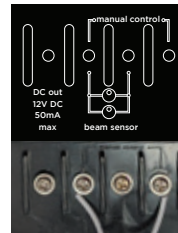

manual override terminals example

**DIY**

**10A DC INPUT**

**2000W MAX LOAD**

**GEOFENCE**

**ALERTS**

**1YR WARRANTY**

## Control your motorised tilt or sectional garage doors remotely.

- Easily connected to your existing motorised garage door controller.
- Open and close your garage door from anywhere with your smartphone through the BrilliantSmart App
- Enable geo-fencing so your garage door opens automatically as you enter your street.
- Receive alerts when your garage door opens or closes in real time.
- Easy-to-add functionality to upgrade your existing motorised garage door.
- Compatible with BrilliantSmart devices via automation & IFTTT.

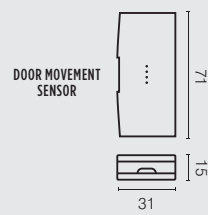
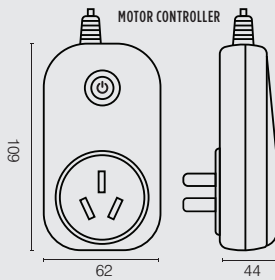

MODEL NO.	COLOUR
21456	White

Voice control

WIFI NO HUB REQUIRED

WORKS WITH alexa

works with the Google Assistant

Works with IFTTT



# ELECTRIC DOOR CONTROLLER

SUITS ROLLER, TILT & SECTIONAL GARAGE DOORS PLUS ELECTRIC GATES



Please check that your existing door motor/controller has manual override terminals.

This may be found behind access panels on your existing garage door motor/controller.

If you momentarily connect these two terminals together (with a wire) and it activates the door then this product will be compatible.

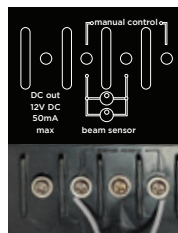

manual override terminals example

**DIY**

**10A DC INPUT**

**2000W MAX LOAD**

**GEOFENCE**

**SMS ALERTS**

**1YR WARRANTY**

Control your motorised tilt, roller or sectional garage doors plus electric gates from anywhere. Feel more secure at home when you set times or geo-fencing.

- Easily connected to your existing motor, our electric door controller enhances with a suite of security and safety features.
- Open and close your garage door or gate from anywhere with your smartphone through the BrilliantSmart App
- Enable geo-fencing so your garage door or gate opens automatically as you enter your street.
- Receive alerts when your garage door or gate opens or closes in real time.
- Easy-to-add functionality to upgrade existing motorised garage door or gate.
- Compatible with BrilliantSmart devices via automation & IFTTT.



MODEL NO.	COLOUR
21457/05	White

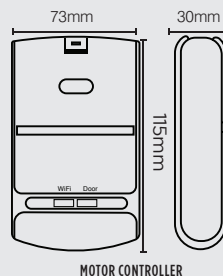

MOTOR CONTROLLER

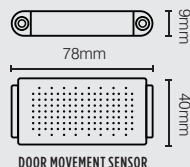

DOOR MOVEMENT SENSOR



Voice control

WIFI NO HUB REQUIRED

WORKS WITH alexa

works with the Google Assistant

Works with IFTTT

# LED STRIP CONTROLLER

RGW + WHITE LED STRIP



**DIY** **12-24V DC INPUT** **2A 4CH OUTPUT** **96W MAX LOAD** **1YR WARRANTY**

Make existing strip lights smart, allowing control and automation from anywhere at any time, via app, voice control or manually.

- Make existing Brilliant RGB+W 5m or 10m strip lighting smart with this connector.
- Create schedules and timing to automate your home.
- Compatible with BrilliantSmart devices via automation & IFTTT.

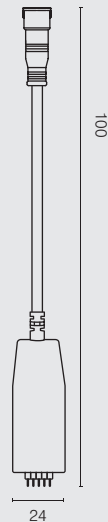

MODEL NO.	COLOUR
20794	White



Voice control

WIFI NO HUB REQUIRED

WORKS WITH alexa

works with the Google Assistant

Works with IFTTT



# SMART PLUG

SINGLE SOCKET WITH USB CHARGER



Conveniently control your electronic devices and appliances anywhere, anytime. Our smart WiFi plugs are easy to set up, give you peace of mind allowing you to remotely manage your favourite devices and schedule them to suit your lifestyle, even if you're not at home.

- Working voltage 240VAC 50Hz. Supports max power: 10A, 2400W. USB Charger: 1 x 5V DC 1500mA.
- Thermal overload/reset.
- Control via app and/or voice control through Amazon Alexa®, Google Assistant® or Siri®.
- Create schedules & timing to automate your home.
- Includes a USB charger.
- Compatible with BrilliantSmart devices via automation & IFTTT.

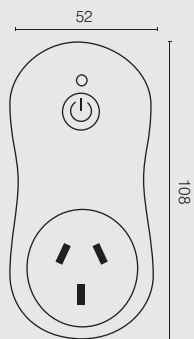

MODEL NO.	COLOUR
20676/05	White

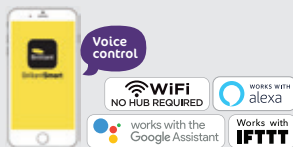

# SMART POWERBOARD

LISBON 4 GANG WITH 4 USB CHARGERS

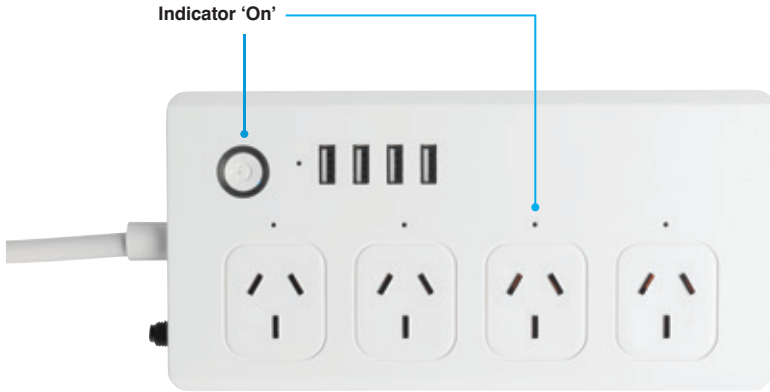

Conveniently control your electronic devices and appliances anywhere, anytime. The Lisbon smart WiFi powerboard is easy to set up, gives you peace of mind allowing you to remotely manage your favourite devices and schedule them to suit your lifestyle, even if you're not at home.

- Control each power outlet individually or USB hub via app and/or voice control through Amazon Alexa®, Google Assistant® or Siri®.
- Working voltage 240VAC 50Hz. Support Max power: 10A, 2400W total. USB Charger: 2100mA 5V total.
- Thermal overload/reset.
- Create schedules & timing to automate your home.
- Includes a USB charger.
- Compatible with BrilliantSmart devices via automation & IFTTT.

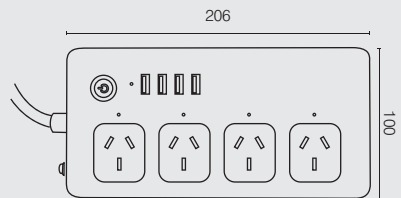

MODEL NO.	COLOUR
20691/05	White

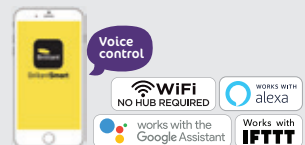

# CEILING FAN

## DC BAHAMA WITH CCT LED LIGHT

**TUNEABLE CCT**  
WARM WHITE TO DAYLIGHT

3000K — 6000K



Remote  
Included



**32W**  
DC MOTOR

**52 INCH**  
1320mm

**14°**  
BLADE  
PITCH

**17°**  
CEILING  
RAKE

**6YR**  
WARRANTY

The smart Bahama fan with tuneable CCT light allows you to control the settings from anywhere, via your phone, app or voice control.

- Durable metal body and canopy construction, with 3 moulded ABS blades.
- 5 speed remote control with reverse function and timer.
- Light: 18W 1000lm LED non-dimmable.
- Control your fan speed, light, and on/off by App.
- Smart mode: nature, normal, sleep and wake up (app only).
- Suitable for indoor or enclosed alfresco areas.
- Compatible with BrilliantSmart devices via automation & IFTTT.

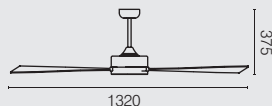

### ACCESSORIES

#### EXTENSION RODS WITH LOOM KITS (sold separately)

- 900mm x Ø21mm  
100550/05 white, 20252/06 matt black, 100550/06 matt black



Voice  
control

WiFi  
NO HUB REQUIRED

WORKS WITH  
alexa

works with the  
Google Assistant

Works with  
IFTTT

MODEL NO.	COLOUR	DESCRIPTION
20918/05	White/White	Fan w/LED light
20918/06	Black/Black	
20918/37	White/Whitewashed Timber	
20918/51	Black/Maple	

SPEED	POWER	RPM	AIRFLOW
5	31W	185	9328 m <sup>3</sup> /hr
4	19W	168	7985 m <sup>3</sup> /hr
3	13W	150	6455 m <sup>3</sup> /hr
2	8W	120	5230 m <sup>3</sup> /hr
1	5W	87	3369 m <sup>3</sup> /hr

# FAN CONTROLLER

TO SUIT AC CEILING FANS

99111

Wall control with quick connect receiver



**70W**  
MAX  
FAN

**100W**  
MAX  
LIGHT

**1YR**  
WARRANTY

Turn your existing AC ceiling fan into a smart fan with our universal smart ceiling fan remote control kit.

- Uses Brilliant's unique quick connect plug-in design, which allows our remote to be installed seamlessly in minutes with any Brilliant AC fan without any wire trimming or joining.
- Compatible with most other brands of AC ceiling fans (hard-wiring may be required).
- Smart mode: nature, normal, sleep and wake up (app only).
- Includes 3-speed with light function wireless operated wall control with batteries (2xAAA).
- Create schedules & timing to automate your home. Control from anywhere via app or voice control.
- Compatible with BrilliantSmart devices via automation & IFTTT.

CONTROL	WALL CONTROL	APP
DISPLAY	N/A	On Device
INPUT	Soft Touch Buttons	On Screen
FAN	ON/OFF	ON/OFF
SPEED	1/2/3	1/2/3
LIGHT	ON/OFF/DIM	ON/OFF/DIM
OTHER	Wireless battery operated	Smart functions available includes Smart mode, scheduling, timers, automation, voice control along with many others in the BrilliantSmart App.

## QUICK CONNECT RECEIVER

The Easy Connect connector plugs for quick and simple installation are only compatible with Brilliant Lighting fans.



Voice control

WIFI  
NO HUB REQUIRED

WORKS WITH  
ALEXA

works with the  
Google Assistant

Works with  
IFTTT







# SECURITY

Have peace of mind knowing your  
home and family are safe and  
allows you to stay connected

# DOORBELL

## VIDEO DOORBELL



BUTTON TURNS **BLUE**  
WHEN MOTION IS  
DETECTED



BUTTON TURNS **RED**  
WHEN DOORBELL IS  
PRESSED



Answer your doorbell from anywhere from your phone. Video, two-way audio and built-in motion sensors allow you to know who's at the front door and detect any movement on your property, triggering alerts to your phone 24/7.

- Full high definition resolution 1080P (FHD) camera, 166° wide viewing angle.
- Two-way audio. Allows you to hear and speak through the BrilliantSmart app remotely.
- Built-in infra-red night vision, automatically activating the infra-red filter at night (day/night modes).
- Manually record to your phone by either screen shot or video recording.
- Durable construction with IP44 weather resistant rating.
- Built in memory card slot supports up to 64Gb max. Recording is motion activated when SD card is installed (card not included).
- Uses low power and includes 2 rechargeable lithium batteries with micro USB cord to recharge batteries.
- Includes option to connect to 14V-24VAC/DC (power source not included).
- Compatible with BrilliantSmart devices via automation & IFTTT.
- Compatible with the smart siren/alarm (via the BrilliantSmart app) and can be used as a door chime anywhere within your home.

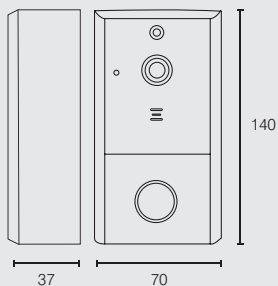

**WORKS WITH  
SMART  
WIFI SIREN  
20708/05**



Works with  
**IFTTT**  
**WIFI**  
NO HUB REQUIRED

MODEL NO.	COLOUR
20761/06	Black

# DOORBELL CHIME

WORKS WITH BRILLIANTSMART DOORBELL



The chime connects to our Wi-Fi Video Doorbell to alert you when the door bell has been pressed.

- Comes with multiple tones, select different tones for different notifications.
- Easily control the volume so you can hear all over the house.
- Do Not Disturb mode allows for quiet when needed.
- Plugs into any standard power outlet.
- Working distance approx 30m from Smart doorbell.

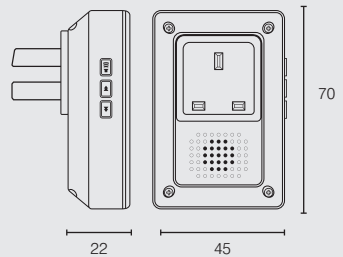

MODEL NO.	COLOUR
21387/06	Black

**ONLY WORKS IN  
CONJUNCTION  
WITH SMART  
WIFI DOORBELL**

# Monitor your home to keep your family safe



# INDOOR CAMERA

HANDY CAMERA



Secure and monitor your home anywhere, anytime with the BrilliantSmart Handy Camera. Ideal for use as a nanny cam, baby monitor or pet cam.

- HD 720P 25fps camera with a 120° field of view video.
- Advanced 1MP CMOS motion and image sensor detects changes in movement and sends a notification to your phone.
- Two-Way audio. Allows you to hear and speak through the BrilliantSmart app no matter where you are.
- Built-in Infra-Red night vision. See in the dark up to 5m with the infrared night vision with remarkable clarity.
- View and manually record live vision and audio direct to your phone through the BrilliantSmart app.
- MicroSD memory card slot – 32Gb max.  
Recording is motion activated if SD card installed (card not included).
- Compatible with BrilliantSmart devices via automation & IFTTT.

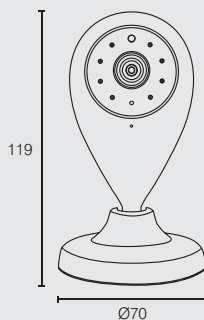

MODEL NO.	COLOUR
20715/05	White



# INDOOR CAMERA

## SWIFT PAN & TILT



### Compact pan & tilt camera featuring a wide viewing angle.

- Full high definition resolution 1080P (FHD) camera, delivers a crystal clear video.
- Remotely operate the camera up, down, left and right with 355° horizontal and 140° vertical view.
- Advanced motion detection identifies slight changes in movement and sends a notification to your phone/tablet.
- Tracking cameras are designed to follow the detected movement and guide the camera in the same direction. Allows camera footage to stay with the moving object/person and improve recording range.
- Two-Way audio. Allows you to hear and speak through the BrilliantSmart app no matter where you are.
- Manually record live video direct to your phone through the BrilliantSmart app.
- MicroSD memory card slot – 128Gb max.  
Recording is motion activated if SD card installed (card not included).
- Access recordings from anywhere with your smartphone.
- Compatible with BrilliantSmart devices via automation & IFTTT.

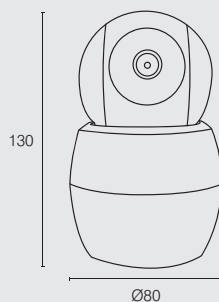

MODEL NO.	COLOUR
20801/05	White



# INDOOR CAMERA

MIA CAMERA



## Small in stature, big in features allowing you see what's happening at your home remotely.

- Full high definition resolution 1080P (FHD) camera, including night vision infra-red detection.
- Advanced motion detection identifies slight changes in movement and sends a notification to your phone/tablet.
- Sound detection to activate camera giving you an extra level of security.
- Two-Way audio. Allows you to speak and listen through the BrilliantSmart app no matter of your location provided you have an internet connection.
- Manually record live video direct to your phone through the BrilliantSmart app.
- MicroSD memory card slot – 132Gb max. Recording is motion activated if SD card installed (card not included).
- Access recordings from anywhere with your smartphone.
- Compatible with BrilliantSmart devices via automation & IFTTT.

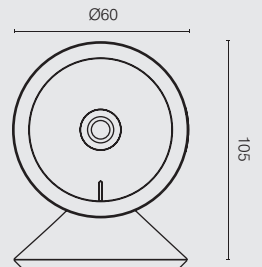

MODEL NO.	COLOUR
21437/05	White



# OUTDOOR CAMERA

## PATROL PAN & TILT



Available  
Soon



**Motion detection and tracking camera with a wide, high definition viewing angle. See what's happening at your home remotely.**

- Full high definition resolution 1080P (FHD) camera, delivers a crystal clear video.
- Remotely operate the camera up, down, left and right with 355° horizontal and 140° vertical view.
- Advanced motion detection identifies slight changes in movement and sends a notification to your phone/tablet.
- Sound detection to activate camera giving an extra level of security.
- Infra-red night vision detection.
- Tracking cameras are designed to follow the detected movement and guide the camera in the same direction. Allows camera footage to stay with the moving object/person and improve recording range.
- Two-Way audio. Allows you to speak and listen through the BrilliantSmart app no matter of your location provided you have an internet connection.
- Manually record live video direct to your phone through the BrilliantSmart app.
- Built in memory 16Gb SD. Older footage is overridden.
- Access recordings from anywhere with your smartphone.
- IP65 Weather-resistant.
- Compatible with BrilliantSmart devices via automation & IFTTT.

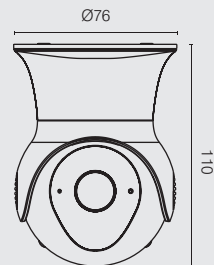

Works with  
**IFTTT**

**WiFi**  
NO HUB REQUIRED

MODEL NO.	COLOUR
21438/05	White



# OUTDOOR BATTERY CAMERA

ZIP RECHARGEABLE CAMERA



Magnetic and rechargeable the robust Smart HD camera allows you the flexibility to mount a security camera anywhere.

- Easy installation
- Attaches to any magnetic surface.
- 4 x 18650 rechargeable lithium-ion batteries included.
- Full high definition resolution 1080P (FHD) camera, from the 110 degree wide viewing angle.
- Advanced PIR motion detection identifies changes in movement and sends a notification to your phone/tablet.
- High quality two-way and one-way audio options.
- Built-in Infra-red night vision, allows you to see in the dark.
- Manually record live video direct to your phone through the BrilliantSmart app.
- MicroSD memory card slot – 128Gb max. Recording is motion activated if SD card installed (card not included).
- Access recordings from anywhere with your smartphone.
- IP65 Weather-resistant.
- Compatible with BrilliantSmart devices via automation & IFTTT.

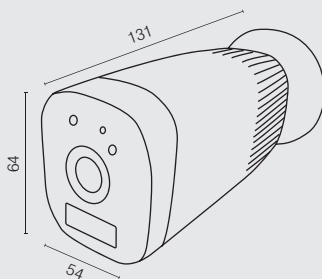

MODEL NO.	COLOUR
21436/05	White



WiFi  
NO HUB REQUIRED

Works with  
IFTTT

# SECURITY CAMERA

## BEAMER FLOODLIGHT WITH CAMERA



Secure your home with the smart floodlight – complete with a powerful motion sensor and camera. The security light comes on when the sensor detects movement.

- Full high definition resolution 1080P (FHD) camera.
- Remotely operate the camera up, down, left and right from anywhere from your phone/tablet.
- Advanced PIR motion detection identifies slight changes in movement and sends a notification to your phone/tablet.
- See in the dark with built-in infrared night vision.
- Manually record live video direct to your phone via the BrilliantSmart app.
- MicroSD memory card slot – 128Gb max. Recording is motion activated if SD card installed (card not included).
- Adjustable sensor functions on time and light.
- IP44 weather resistant rating.
- Made from durable UV stabilised polycarbonate – ideal for coastal environments.
- Lux setting, detection: 180°x12m, time on: 3sec to 7min (override always on).
- Compatible with BrilliantSmart devices via automation & IFTTT.

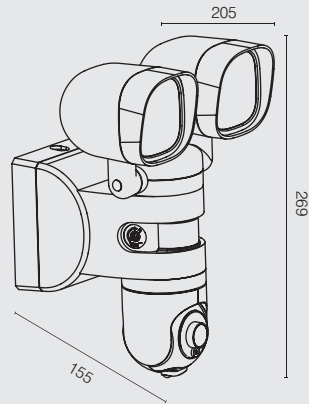

MODEL NO.	COLOUR
20762/06	Black



# SOLAR OUTDOOR CAMERA

TRIDENT OUTDOOR



The powerful Smart solar operated HD camera, enables control via the BrilliantSmart App on your phone.

- Solar powered – no cords, no wiring, truly wireless and easy to install.
- Full high definition resolution 1080P (FHD) camera, delivers a crystal clear video.
- Advanced PIR motion detection identifies changes in movement and sends a notification to your phone/tablet.
- Two-way and one-way audio options.
- Built-in Infra-red night vision, allows you to see in the dark.
- Manually record live video direct to your phone through the BrilliantSmart app.
- MicroSD memory card slot – 128Gb max. Recording is motion activated if SD card installed (card not included).
- Access recordings from anywhere with your smartphone.
- IP65 Weather-resistant, so suitable to mount outdoors.
- 4 x 18650 rechargeable batteries included.
- Compatible with BrilliantSmart devices via automation & IFTTT.

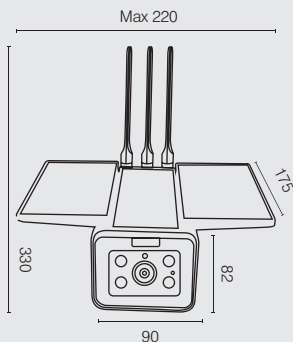

MODEL NO.	COLOUR
21007/05	White



# SECURITY LIGHT

## ESCORT CCT FLOODLIGHT

TUNEABLE CCT  
WARM WHITE TO DAYLIGHT

3000K — 6000K



22W  
2200lm



IP44  
RATING

2YR  
WARRANTY

This smart floodlight deters intruders and lights up your home exterior. The built-in sensor triggers the light to come on when movement is detected. Control from anywhere via app, voice control or manually.

- Adjustable sensor functions on time, motion and light sensitivity.
- Manual override available through BrilliantSmart App allows you to turn the light on or off.
- Easily tuneable colour changing temperature (CCT) warm white 3000K to bright daylight 6000K.
- Latest in ultra-bright COB LED technology, with built-in 11W LEDs.
- Made from durable diecast aluminium.
- IP44 weather resistant for outdoor installation.
- Dimmable via app or voice control through Amazon Alexa® or Google Home®.
- Create schedules & timing to automate your home.
- Compatible with BrilliantSmart devices via automation & IFTTT.

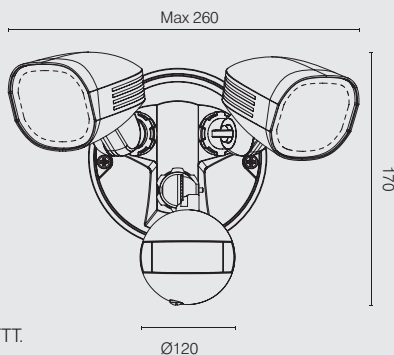

MODEL NO.	COLOUR
20700/06	Black



Voice control

WIFI  
NO HUB REQUIRED

WORKS WITH  
ALEXA

WORKS WITH THE  
GOOGLE ASSISTANT

WORKS WITH  
IFTTT

# OUTDOOR SENSOR

## BOXER PIR SENSOR



**110°/12m**  
DETECTION  
RANGE



**IP65**  
RATING

**2YR**  
WARRANTY

Advanced PIR motion detection identifies changes in movement to activate lighting. Change the settings from anywhere via app or voice control or manually.

- Multi-segmented optical lens for better movement detection.
- 3-wire design for greater reliability.
- Easy to mount on walls, eaves or ceiling.
- On/Off button (manual override) in the App.
- Heavy duty switching circuitry suitable for large loads (2000W Incandescent lamp; 600W Fluorescent lamp; 300W LED lamp).
- Operating temperature: 5°C to 40°C
- Lux level controlled by the app : Dark – Dusk – Daylight.
- Sensitivity controlled by app: Low – Mid – High.
- Range: 110°x 18m.
- Light controlled by app: Auto – Override – Test.
- Power consumption: 0.7W.
- IP65 weather-resistant for outdoor installation.
- Compatible with BrilliantSmart devices via automation & IFTTT.

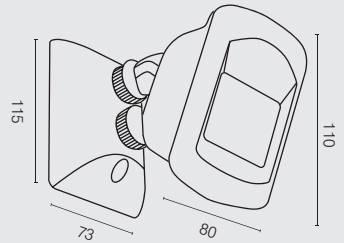

MODEL NO.	COLOUR
20707/06	Black



Voice  
control

WIFI  
NO HUB REQUIRED

WORKS WITH  
alexa

works with the  
Google Assistant

Works with  
IFTTT

# MOTION SENSOR

INDOOR SENSOR



Make your home react to motion. Have your lights, cameras or other smart products automatically turn on when motion is detected, so you can view what's happening or receive an alert on your smartphone.

- Battery powered – DIY installation with no cables, so it is completely wireless and easy to install anywhere in your home in minutes.
- Detects movement within a range of 4–6m.
- Receive push notifications to your smart phone/tablet through the BrilliantSmart app when the sensor is triggered.
- Everything is supplied in the box to get you started including 1 x CR123A battery.
- Compatible with BrilliantSmart devices via automation & IFTTT.

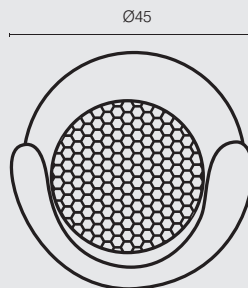

MODEL NO.	COLOUR
20708/05	White



# CONTACT SENSOR

DOOR/WINDOW REED SWITCH



Secure your home with the Brilliant Smart WiFi Reed Switch. The Smart Reed Switch activates once the door or window is opened/closed, and can be used to activate other BrilliantSmart devices such as alarms, sensors, cameras, or lighting.

- No cables, so you can place it anywhere in your home. The reed switch is battery powered, so it is completely wireless and easy to install in minutes.
- Everything is supplied in the box to get you started including 1 x CR2A battery.
- Compatible with BrilliantSmart devices via automation & IFTTT.

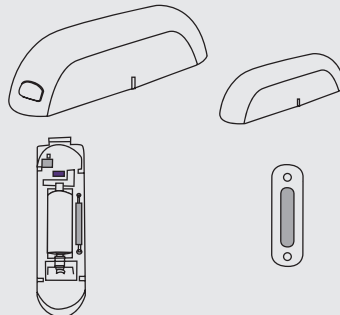
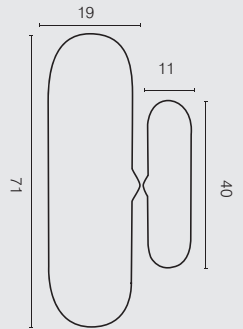

MODEL NO.	COLOUR
20714/05	White



# SIREN

## SECURITY SIREN /ALARM



Automate, customise and control your home from anywhere. The Siren/Alarm produces a powerful 90dB siren plus a visible blue indicator light when triggered to deter intruders.

- No cables, so you can place it anywhere in your home. The siren is battery powered, so it is completely wireless and easy to install in minutes.
- Can be powered by either USB (1m cable supplied) or battery – 2 x CR123A-3V (not included).
- Supports 10 different alarm chimes allowing you to set a different alarm sound to alert you to different events, such as home intrusion, in-home doors opening and even mail delivery.
- Compatible with other BrilliantSmart devices and can be triggered by our reed switch, PIR sensor or a camera.
- Compatible with our smart doorbell (via the BrilliantSmart app) and can be used as a door chime anywhere within your home.

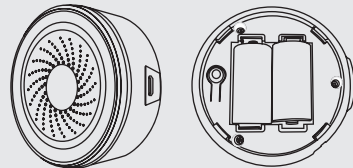
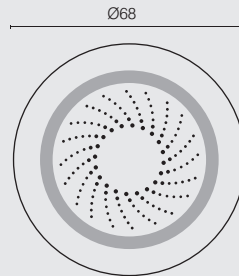

MODEL NO.	COLOUR
20712/05	White





# COMPLETE SECURITY KIT

SMART SIREN, PIR SENSOR, DOORBELL, REMOTE CONTROL & DOOR/WINDOW REED SWITCH



Secure & monitor your home. Anywhere, Anytime.  
The Siren produces a very powerful 120dB siren to deter intruders.

- 3 alarm modes:  
**Arm:** Alarm with sound & light flash  
**Home:** Alarm with light flash  
**Disarm:** Only SOS alarm available.
- Connect Smart siren to WiFi then all items connect easily by Remote Frequency (RF).
- PIR motion detection.
- Tamper-proof – alarm sounds if intruder tries to disable item.
- Works when WiFi down.
- Can trigger other BrilliantSmart products by creating app automation.

MODEL NO.	COLOUR
21518	White



Hey Google

Alexa

Turn on kitchen light!

Dim the light 50%!

Change colour to red!

Change to warm white!





# LIGHTING

Brings elegance, ambience, convenience  
whilst providing energy efficiency to  
your whole home – Inside and Out

# DOWNLIGHT

## TRILOGY CCT

TUNEABLE CCT  
WARM WHITE TO NATURAL

3000K — 5000K

AMOUNT  
OF DEVICES  
IS LIMITED TO  
YOUR WIFI  
ROUTER



FRONT ONLY

Experience light that feels natural, from the warm white of a relaxed evening to cool daylight and control your lights from anywhere via app or voice control.

- Create schedules & timing to automate your home.
- Adjust the colour temperature and dim to suit your mood.
- Tune the colour temperature from a warm white 3000K to natural white 5000K.
- Provides a wide diffusion with up to 750 lumens of clear, crisp light from a 9W LED light source.
- Fits in to standard 90mm cut-outs, perfect for new or retro-fit installations.
- Dimmable via app and/or voice control through Amazon Alexa®, Google Assistant® or Siri®.
- Compatible with BrilliantSmart devices via automation & IFTTT.

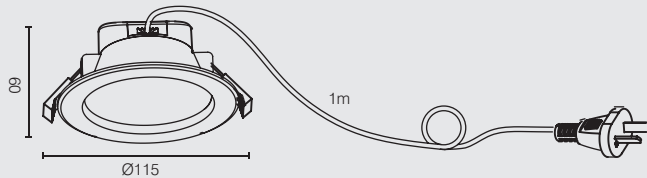

MODEL NO.	WATTAGE (W)	COLOUR
20695/05	9W	White



Voice control

WIFI  
NO HUB REQUIRED

works with alexa

works with the Google Assistant

Works with IFTTT

# DOWNLIGHT

PRISM RGB + CCT

TUNEABLE CCT  
WARM WHITE TO NATURAL

3000K — 5700K



AMOUNT  
OF DEVICES  
IS LIMITED TO  
YOUR WIFI  
ROUTER



FRONT ONLY

Create the perfect ambiance with millions of colours to choose from to set the scene for a romantic evening or movie marathon to reading, relaxation and more and control your lights from anywhere via app or voice control.

- Create schedules & timing to automate your home.
- Adjust the colours, brightness or colour temperature and dim to suit your mood.
- Tune the colour temperature from a warm white 3000K to natural white 5700K.
- Provides a wide diffusion with up to 800 lumens of clear, crisp light from a 10W LED light source.
- Fits in to standard 90mm cut-out, perfect for new or retro-fit installations.
- Dimmable via app and/or voice control through Amazon Alexa®, Google Assistant® or Siri®.
- Compatible with BrilliantSmart devices via automation & IFTTT.

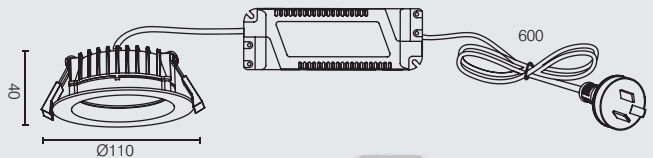

MODEL NO.	WATTAGE (W)	COLOUR
20716/05	10W	White



Voice control

WIFI  
NO HUB REQUIRED

WORKS WITH  
ALEXA

works with the  
Google Assistant

WORKS WITH  
IFTTT

# LED GLOBE

## CCT A60 SERIES II

### TUNEABLE CCT

WARM WHITE TO DAYLIGHT

2700K — 6500K



Make your existing lights smart and experience light that feels natural. From the warm white of a relaxed evening to cool daylight – with the Colour Changing Technology (CCT) globe you can enjoy any tone of white light to fit your mood or activity.

- Control from anywhere via app or voice control.
- Set schedules, adjust the colour temperature and dim to suit your mood.
- Tune the colour temperature from a warm 2700K to a bright daylight 6500K.
- Provides a 220 degree beam with up to 800 lumens of clear, crisp light from a 8.5W LED light source.
- Dimmable via app and/or voice control through Amazon Alexa®, Google Assistant® or Siri®.
- Compatible with BrilliantSmart devices via automation & IFTTT.

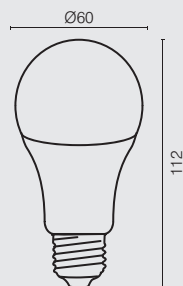

MODEL NO.	WATTAGE (W)	LUMENS (lm)	BASE	SIZE
20696	8.5W	800	E27	Ø60 x 112mm
20697	8.5W	800	B22	Ø60 x 110mm



# LED GLOBE

RGB + WHITE A60 SERIES II



Create the perfect ambiance with millions of colours to choose from to set the scene for a romantic evening or movie marathon to reading, relaxation and more. The RGB plus white globe lets you experience light to fit your mood or activity.

- Control from anywhere via app or voice control.
- Set schedules, adjust the colours, brightness or colour temperature and dim to suit your mood.
- Design different colour scenes and brightness so you can easily change its colour or luminosity to suit your mood.
- Provides a 220 degree beam with up to 800 lumens of warm light from a 8.5W LED light source.
- Dimmable via app and/or voice control through Amazon Alexa®, Google Assistant® or Siri®.
- Compatible with BrilliantSmart devices via automation & IFTTT.

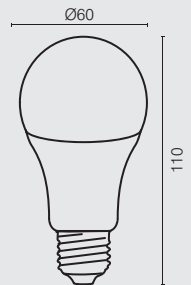

MODEL NO.	WATTAGE (W)	LUMENS (lm) white only	BASE	SIZE
20698	8.5W	800	E27	Ø60 x 112mm
20699	8.5W	800	B22	Ø60 x 110mm



# LED GLOBE

## CCT GU10 SERIES II

**TUNEABLE CCT**  
WARM WHITE TO DAYLIGHT

2700K — 6500K



Make your lamps, spotlights and exterior lighting smart with these GU10 globes. With Colour Changing Technology (CCT) you can enjoy any tone of white light to fit your mood or activity – from warm white to cool daylight.

- Control from anywhere via app or voice control.
- Create schedules & timing to automate your home.
- Adjust the colour temperature and dim to suit your mood.
- Tune the colour temperature from a warm 2700K to a bright daylight 6500K.
- Provides a 45 degree beam with up to 400 lumens of clear, crisp light from a 5W LED light source.
- Working voltage 240VAC 50Hz.
- Fits in most GU10 fittings to make your existing lighting smart.
- Dimmable via app and/or voice control through Amazon Alexa®, Google Assistant® or Siri®.
- Compatible with BrilliantSmart devices via automation & IFTTT.

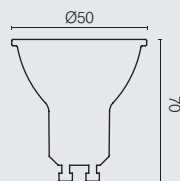

MODEL NO.	WATTAGE (W)	LUMENS (lm)	BASE	SIZE
20764	4.5W	400	GU10	Ø50 x 70mm





# LED GLOBE

RGB + WHITE GU10 SERIES II



Make your lamps, spotlights and exterior lighting smart with these GU10 globes. Use the app to change the millions of colours to create any mood and ambience to suit your home.

- Control from anywhere via app or voice control.
- Create schedules & timing to automate your home.
- Adjust the colours, brightness or colour temperature and dim to suit your mood.
- Design different colour scenes and brightness so you can easily change its colour or luminosity to suit your mood.
- Provides a 45 degree beam with up to 400 lumens of warm light from a 5W LED light source.
- Fits in most GU10 fittings to make your existing lighting smart.
- Dimmable via app and/or voice control through Amazon Alexa®, Google Assistant® or Siri®.
- Compatible with BrilliantSmart devices via automation & IFTTT.

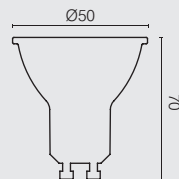

MODEL NO.	WATTAGE (W)	LUMENS (lm) white only	BASE	SIZE
20765	4.5W	400	GU10	Ø50 x 70mm



Voice control

WIFI  
NO HUB REQUIRED

WORKS WITH  
ALEXA

works with the  
Google Assistant

Works with  
IFTTT

# OYSTER

## CORDIA CCT

### TUNEABLE CCT

WARM WHITE TO NATURAL

3000K — 5700K



24W  
2200lm



CRI  
>82



Experience light that feels natural, from the warm white of a relaxed evening to cool daylight and control your lights from anywhere via app or voice control.

- Create schedules & timing to automate your home.
- Adjust the colour temperature and dim to suit your mood.
- Tune the colour temperature from a warm white 3000K to a natural white 5700K.
- Provides a wide diffused light with up to 2200 lumens of clear, crisp light from a 24W LED light source.
- Dimmable via app and/or voice control through Amazon Alexa®, Google Assistant® or Siri®.
- Compatible with BrilliantSmart devices via automation & IFTTT.

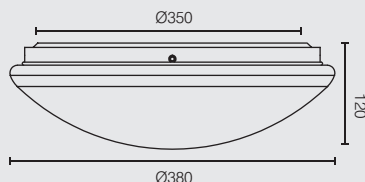

MODEL NO.	WATTAGE (W)	COLOUR
20717/05	24W	White



Voice control

WIFI  
NO HUB REQUIRED

WORKS WITH  
ALEXA

works with the  
Google Assistant

Works with  
IFTTT



# GARDEN

Transform the outside of your home in minutes with BrilliantSmart garden lights

# GARDEN LIGHT KIT

## BOTANIC RGB 4 PACK



Using millions of colours, design different colour scenes and brightness to suit your mood. Highlight objects, trees or pathways to make your space stand out.

- Adjustable head with 60 degree directional beam.
- An IP68 weather resistant rating for outdoor installation.
- Durable UV stabilised polycarbonate ideal for coastal environments.
- Create schedules & timing to automate your home.
- Dimmable via app and/or voice control through Amazon Alexa®, Google Assistant® or Siri®.
- Control from anywhere via app or voice control.
- Compatible with BrilliantSmart devices via automation & IFTTT.

#### 4 PACK INCLUDES

- 4 x LED 3W RGB spotlight, 4 core x 0.35mm<sup>2</sup> 2.5m cable, junction box and 160mm plastic stake.
- 240V/12V 2A 24W Transformer with 1.5m cord/plug.
- Smart controller with 1 x 2-pin 12V DC 2A input, 1 x 4-pin 12V DC 5A RGB and 1 x 2-pin 12V DC 5A single light colour output.
- Total cable length, 11m.

#### ACCESSORIES

20703/06 Black RGB garden light with spike  
(maximum 8 lights can be connected to this kit).

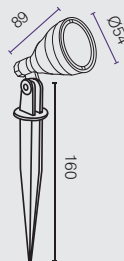

MODEL NO.	COLOUR
20702/06	Black



# GARDEN CONTROLLER

**BOTANIC RGB & SINGLE COLOUR**



RGB colour changing



RGB  
4 PIN DC  
OUTPUT

SINGLE  
COLOUR  
2 PIN DC  
OUTPUT

12V DC  
INPUT

**DIY**

**12V  
DC**

**IP68  
WEATHER  
RESISTANT**

**2YR  
WARRANTY**

Make your existing garden lighting smart with BrilliantSmart garden light controller. With millions of colours to choose from, you can create the ideal mood or lighting effect. Highlight objects, trees or pathways to make your space stand out.

- An IP68 weather resistant rating for outdoor installation.
- Easy and safe DIY installation.
- Create schedules & timing to automate your home.
- Dimmable via app and/or voice control through Amazon Alexa®, Google Assistant® or Siri®.
- Control from anywhere via app or voice control.
- Connects to other Brilliant Plug & Play garden light ranges.
- Compatible with BrilliantSmart devices via automation & IFTTT.
- Smart controller with 1 x 2-pin 12V DC 2A input, 1 x 4-pin 12V DC 5A RGB and 1x 2-pin 12V DC 5A single light colour output.

## ACCESSORIES

- 20703/06 Black RGB garden light with spike
- 20704/06 Black RGB garden light cable 2.5m
- 19915/06 2A/24W Transformer
- 19916/06 3A/36W Transformer
- 19917/06 5A/60W Transformer

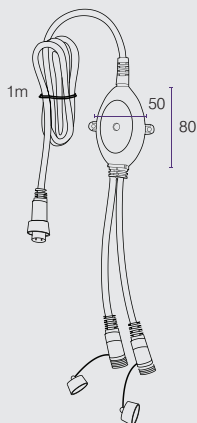

MODEL NO.	COLOUR
20701/06	Black



Voice control

WIFI  
NO HUB REQUIRED

WORKS WITH  
ALEXA

works with the  
Google Assistant

Works with  
IFTTT





# COMMERCIAL

Brilliant's commercial range of lighting solutions for all industries including offices, education, retail and hospitality

# DISCUS-II HIGHBAY

LED INDUSTRIAL HIGHBAY – 120W



- Thermal management system (TMS) will begin to reduce power/light output when ambient temperature increases to above 45 degrees celsius.
- Black diecast alloy housing with painted steel bracket.
- 304 stainless steel hook and external bolts.
- High performance LED SMD array.
- High efficiency LED driver with 1.5m flex & plug.

**VEET (ESC): 5859**  
**IPART: 01848S16-VKEIIDIA**

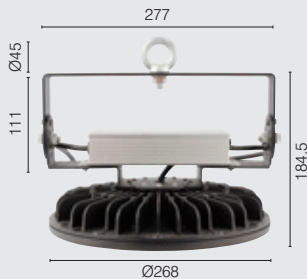

HIGHBAY	
Code	20424
Wattage	120W
Operating Voltage	240V 50Hz
Lumens	14,500 Lumens
LED Type	168 pcs SMD
Colour Temp	5000K
Beam Angle	110 degrees
IP Rating	IP67
Dimmable	No
CRI	>70
Max. Ta (Safety)	50° Celsius
Construction	Class I
Weight	3.8kg
Rated Lifetime	30,000 hours (50°C Ambient)



# DISCUS-II HIGHBAY

LED INDUSTRIAL HIGHBAY – 200W



**200W**  
LED  
25000lm

**5000K**  
NATURAL  
LIGHT

**110°**  
BEAM  
ANGLE

**CRI**  
**>70**

**TMS**

**IP67**  
RATING

**5YR**  
WARRANTY

- Thermal management system (TMS) will begin to reduce power/light output when ambient temperature increases to above 45 degrees celsius.
- Black diecast alloy housing with painted steel bracket.
- 304 stainless steel hook and external bolts.
- High performance LED SMD array.
- High efficiency LED driver with 1.5m flex & plug.

**VEET (ESC): 5859**

**IPART: 01848S16-VKEIIDIA**



HIGHBAY	
Code	20425
Wattage	200W
Operating Voltage	240V 50Hz
Lumens	25,000 Lumens
LED Type	224 pcs SMD
Colour Temp	5000K
Beam Angle	110 degrees
IP Rating	IP67
Dimmable	No
CRI	> 70
Max. Ta (Safety)	50° Celsius
Construction	Class I
Weight	25.4kg
Rated Lifetime	20,000 hours (50°C Ambient)

# LED PANEL

1200mm x 300mm COLOUR TEMPERATURE CHANGING

## TUNEABLE CCT

3000K — 6500K



- Efficient edgelit design with uniform light output.
- Switchable between Warm White (3000K), Cool White (4200K) & Daylight (6500K).
- Designed to fit standard T-Bar ceilings and Brilliant recessed plaster kit.
- Long lasting up to 30,000 hours.
- External driver with flex & plug. (Total length 1 metre).
- Indoor use only.

### APPLICATIONS

- Office room, meeting room, classroom.
- Shopping mall, super market, retailer shops.
- Hospital, laboratory, dust-free workshop.

### ACCESSORIES

- Recessed plaster kit, size: outer 1235L x 335W x 30Hmm, inner 1185L x 285W.
- Surface mount kit, size: 1202L x 300W x 50Hmm.

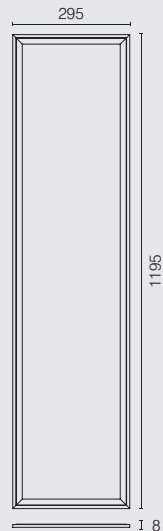

MODEL NO.	WATTAGE (W)	LUMENS @ 3000K (lm)	LUMENS @ 4200K (lm)	LUMENS @ 6500K (lm)	COLOUR	DESCRIPTION
20280/05	38	2800	3200	3000	White	Panel Only
19625/05	NA	NA	NA	NA	White	Recessed Plaster Kit
20740/05	NA	NA	NA	NA	White	Surface Mount Kit

# LED PANEL

600mm x 300mm COLOUR TEMPERATURE CHANGING

TUNEABLE CCT

3000K — 6500K



18W  
LED

CRI  
>80

IC-F  
ABUTTED &  
COVERED



3YR  
WARRANTY

- Efficient edgelit design with uniform light output.
- Switchable between Warm White (3000K), Cool White (4200K) & Daylight (6500K).
- Long lasting up to 30,000 hours.
- External driver with flex & plug. (Total length 1 metre).
- Indoor use only.

#### APPLICATIONS

**Office room, meeting room, class room.**

- Shopping mall, super market, retailer shops.
- Hospital, laboratory, dust-free workshop.

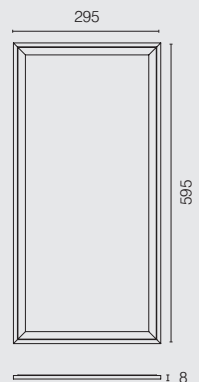

MODEL NO.	WATTAGE (W)	LUMENS @ 3000K (lm)	LUMENS @ 4200K (lm)	LUMENS @ 6500K (lm)	COLOUR
20457/05	18	1500	1700	1550	White



# LED PANEL

1200mm x 600mm COLOUR TEMPERATURE CHANGING

TUNEABLE CCT

3000K — 6500K



48W  
LED

CRI  
>80

IC-F  
ABUTTED &  
COVERED



3YR  
WARRANTY

- Efficient edgelit design with uniform light output.
- Switchable between Warm White (3000K), Cool White (4200K) & Daylight (6500K).
- Designed to fit standard T-Bar ceilings.
- Long lasting up to 30,000 hours.
- External driver with flex & plug.  
(Total length 1 metre).
- Indoor use only.

## APPLICATIONS

### Office room, meeting room, class room.

- Shopping mall, super market, retailer shops.
- Hospital, laboratory, dust-free workshop.

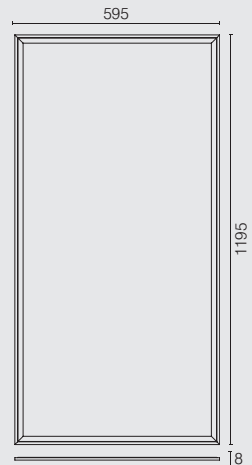

MODEL NO.	WATTAGE (W)	LUMENS @ 3000K (lm)	LUMENS @ 4200K (lm)	LUMENS @ 6500K (lm)	COLOUR
20456/05	48	4300	4700	4500	White

# LED PANEL BACKLIT

1200mm x 300mm



**36W LED**  
3700lm

**4200K**  
COOL  
WHITE

**100°**  
BEAM  
ANGLE

**CRI**  
**> 80**

**IC-F**  
ABUTTED &  
COVERED



**2YR**  
WARRANTY

- Backlit design provides higher efficiency at more than 100lm/W.
- Lightweight and easy to install.
- Slim design, slim profile.
- See clearly with a crisp cool white 4200K light.
- Designed to fit standard T-Bar ceilings, brilliant recessed plaster kit and surface mount kit.
- Long lasting up to 30,000 hours.
- External driver with flex & plug (total length 1.2m).
- Indoor use only.

## APPLICATIONS

**Office & school lighting: office room, meeting room, class room.**

- Commercial lighting: shopping mall, supermarket, retailer shops.
- Other situations: hospital, laboratory, dust-free workshop.

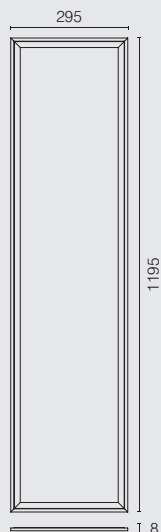

MODEL NO.	WATTAGE (W)	COLOUR TEMP (K)	LUMENS (lm)	COLOUR
21472/05	36	4200	3700	White

# LED PANEL BACKLIT

1200mm x 300mm COLOUR TEMPERATURE CHANGING

TUNEABLE CCT

3000K — 6500K



- Backlit design provides higher efficiency at more than 100lm/W.
- Lightweight and easy to install.
- Slim design, slim profile.
- Switchable between Warm White (3000K), Cool White (4200K) & Daylight (6500K).
- Designed to fit standard T-Bar ceilings.
- Long lasting up to 30,000 hours.
- External driver with flex & plug (total length 1.2m).
- Indoor use only.

## APPLICATIONS

**Office & school lighting: office room, meeting room, class room.**

- Commercial lighting: shopping mall, supermarket, retailer shops.
- Other situations: hospital, laboratory, dust-free workshop.



MODEL NO.	WATTAGE (W)	LUMENS @ 3000K (lm)	LUMENS @ 4200K (lm)	LUMENS @ 6500K (lm)	COLOUR
21473/05	36	3500	3900	3800	White

# LED PANEL BACKLIT

600mm x 600mm



- Backlit design provides higher efficiency at more than 100lm/W.
- Lightweight and easy to install.
- Slim design, slim profile.
- See clearly with a crisp cool white 4200K light.
- Designed to fit standard T-Bar ceilings, brilliant recessed plaster kit and surface mount kit.
- Long lasting up to 30,000 hours.
- External driver with flex & plug (total length 1.2m).
- Indoor use only.

## APPLICATIONS

**Office & school lighting: office room, meeting room, class room.**

- Commercial lighting: shopping mall, supermarket, retailer shops.
- Other situations: hospital, laboratory, dust-free workshop.

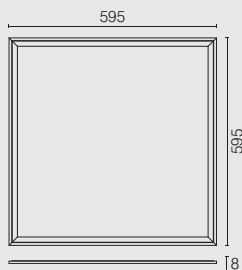

MODEL NO.	WATTAGE (W)	COLOUR TEMP (K)	LUMENS (lm)	COLOUR
21474/05	36	4200	3700	White



# LED PANEL BACKLIT

600mm x 600mm COLOUR TEMPERATURE CHANGING

TUNEABLE CCT

3000K — 6500K



- Backlit design provides higher efficiency at more than 100lm/W.
- Lightweight and easy to install.
- Slim design, slim profile.
- Switchable between Warm White (3000K), Cool White (4200K) & Daylight (6500K).
- Designed to fit standard T-Bar ceilings.
- Long lasting up to 30,000 hours.
- External driver with flex & plug (total length 1.2m).
- Indoor use only.

## APPLICATIONS

**Office & school lighting: office room, meeting room, class room.**

- Commercial lighting: shopping mall, supermarket, retailer shops.
- Other situations: hospital, laboratory, dust-free workshop.

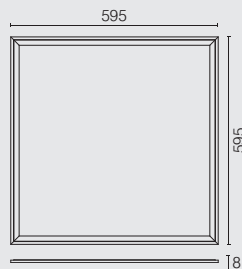

MODEL NO.	WATTAGE (W)	LUMENS @ 3000K (lm)	LUMENS @ 4200K (lm)	LUMENS @ 6500K (lm)	COLOUR
21475/05	36	3500	3900	3800	White

# ENVIRO LED

## LED LOW PROFILE DIFFUSED BATTEN



**40W LED**  
**3400lm**

**4200K**  
COOL  
WHITE

**CRI**  
**> 83**

**3YR**  
WARRANTY

- Slim low profile design.
- Light weight powder coated aluminium housing.
- Integrated LED array.
- Shatter-resistant UV stabilised polycarbonate diffuser.
- Non-dimmable.
- Direct mounting (no brackets).
- Up to 30,000 hours lifetime @ 40°C ambient.
- IP20 Indoor use only.



MODEL NO.	WATTAGE (W)	COLOUR TEMP (K)	LUMENS (lm)	COLOUR
20202/05	40	4200K	3400	White

# LED SLIMLINE BATTEN

COLOUR TEMPERATURE CHANGING INDOOR FITTING

TUNEABLE CCT



CW  
DL ■ WW  
SWITCH ON SIDE  
OF LIGHT

20W LED  
1900lm

40W LED  
3800lm

CRI  
>83

3YR  
WARRANTY

20009/05 | 20010/05

- Change between Warm White (3000K), Cool White (4200K) & Daylight (6500K).
- Slide switch located on the end of fitting.
- Elegant slimline profile.
- Aluminium body with polycarbonate end caps and diffuser.
- Integrated LED.
- Long lasting up to 30,000 hours\*.
- High efficient and uniform light output.
- IP20 Indoor rating.
- Mounts directly to surface, brackets not required.
- Cable entry hole located at the centre position on the rear of the fixture.
- Non-dimmable.

## BENEFITS

- Instant flicker free start.
- Easy-installation for fast retro-fitting.
- Improved illumination quality.

## APPLICATIONS

General commercial interiors, corridors, warehousing, garage and indoor storage areas.

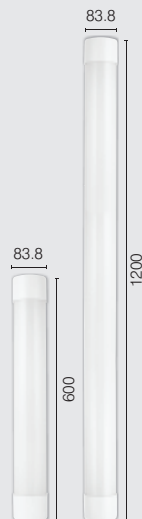

MODEL NO.	WATTAGE (W)	LUMENS @ 3000K (lm)	LUMENS @ 4200K (lm)	LUMENS @ 6500K (lm)	COLOUR
20009/05	20	1700	1900	1800	White
20010/05	40	3400	3800	3600	White

\* At 40°C ambient temperature. Actual life may vary depending on individual circumstances.

Depth: 36.5mm

# PROXIMA

## LED BATTEN



### Also available in Emergency version

- Compliant to AS/NZS 2293.
- Big bore terminal block.
- Ceiling mount.
- Powder coated steel body and Opal PMMA diffuser.
- IP20 rating.
- Fully tested & compliant with Australian Standards.

### APPLICATIONS

Commercial and interior applications, coastal environment, apartments, shopping centres, hospitality, prisons and hospitals.

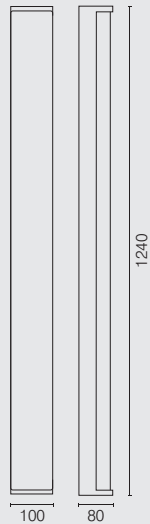

MODEL NO.	COLOUR	DESCRIPTION
19994/05	White	Non-Emergency Model



**20W LED**  
**1600lm**

19997

**40W LED**  
**3200lm**

19998

**6W LED**  
**SUSTAIN**  
**LAMP**

19992

**4200K**  
**COOL**  
**WHITE**

**CRI**  
**> 80**

**IP65**  
**RATING**

**IK08**

**MAINTAINED**

**3YR**  
**WARRANTY**

### Also available in Emergency version

- Corrosion resistant, self extinguishing polycarbonate body.
- Vandal-resistant IK08 rated.
- UV stabilised high impact polycarbonate cover.
- Stainless steel mounting brackets for easy installation.
- Compliant to AS/NZS 2293.
- Ceiling mount.
- IP65 rating.
- Fully tested & compliant with Australian Standards.

### Emergency Model Features

- C0: D25; C90: D63 classifications
- High density storage LiCoO<sub>2</sub> (3600mAh) batteries
- 2 Hour duration period
- Charger type: Trickle
- Charger time: 16 Hours
- Charger operation: Continuous

### APPLICATIONS

Wet rooms, commercial and interior applications, coastal environment, apartments, shopping centres, carparks, stairwells, hospitality, prisons and hospitals.

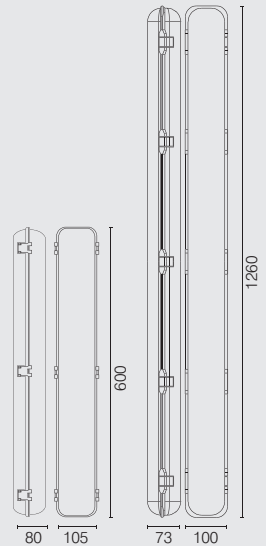

MODEL NO.	COLOUR	LENGTH	DESCRIPTION
<b>19997/08</b>	Grey	600mm	Non-Emergency Model
<b>19998/08</b>	Grey	1200mm	Non-Emergency Model
<b>19992/08</b>	Grey	1200mm	Emergency Model

# CENTAUR

## COLOUR TEMPERATURE CHANGING SHOP LIGHT

### TUNEABLE CCT

3000K — 5000K



- Dimmable.
- Switchable between Warm White (3000K), Cool White (4000K) & Natural White (5000K), switch located on the driver.
- Adjustable design.
- External driver with flex & plug. (Total length 1.2 metres).
- Light can be abutted against or covered with thermal/building insulation.
- Indoor use only.

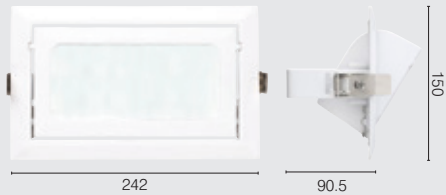

### APPLICATIONS

**Office & school lighting: office room, meeting room, class room.**

- Commercial lighting: shopping mall, super market, retailer shops.
- Other situations: hospital, laboratory, dust-free workshop.

MODEL NO.	WATTAGE (W)	LUMENS @ 3000K (lm)	LUMENS @ 4000K (lm)	LUMENS @ 5000K (lm)	COLOUR
20459/05	35	3400	3500	3300	White

## COLOUR TEMPERATURE CHANGING SNORKEL SHOP LIGHT

### TUNEABLE CCT



- Dimmable.
- Switchable between Warm White (3000K), Cool White (4000K) & Natural White (5500K), switch located on the driver.
- Adjustable snorkel design.
- Long lasting up to 30,000 hours.
- External driver with flex & plug. (Total length 1 metre).
- Indoor use only.

### APPLICATIONS

**Office & school lighting: office room, meeting room, class room.**

- Shopping mall, super market, retailer shops.
- Hospital, laboratory, dust-free workshop.

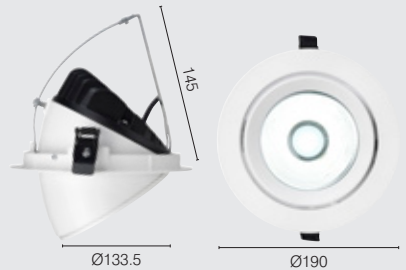

MODEL NO.	WATTAGE (W)	LUMENS @ 3000K (lm)	LUMENS @ 4000K (lm)	LUMENS @ 5500K (lm)	COLOUR
20458/05	30	2100	2400	2300	White

# CENTURION

## IP65 OYSTER



28W LED  
2100lm

4200K  
COOL  
WHITE

CRI  
> 80

IP65  
RATING

  
IK08

3YR  
WARRANTY

- Also available in Emergency version
- Compliant to AS/NZS 2293.
- Big bore terminal block.
- Vandal-resistant IK08 rated.
- Energy efficient high output 28 watt LED.
- Surface ceiling mount.
- Injection moulded polycarbonate housing.
- IP65 rating.
- TA40 - maximum thermal ambient operating temperature.

### APPLICATIONS

Wet rooms, commercial and interior applications, coastal environment, apartments, shopping centres, hospitality, prisons and hospitals.

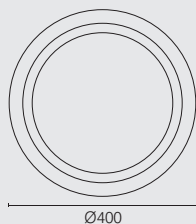

MODEL NO.	COLOUR	DESCRIPTION
19989/05	White	Non-Emergency Model
19987/05	White	Emergency Model



### TUNEABLE CCT

3000K — 6500K



- Change between Warm White (3000K), Cool White (4200K) & Daylight (6500K) via a switch on the back of the downlight.
- Rated for IC abutted and covered usage to allow for covering with thermal insulation.
- Wide 100 degree beam angle.
- SAA approved with external dimmable LED driver.
- Long lasting up to 30,000 hours<sup>1</sup>.
- 1m flex & plug fitted.
- IP44 (front only).
- Four common cut-out sizes to suit most retrofit applications.

### APPLICATIONS

All interior domestic and commercial rooms.

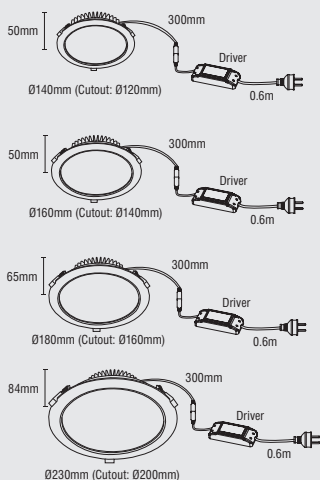

MODEL NO.	WATTAGE (W)	LUMENS @ 3000K (lm)	LUMENS @ 4200K (lm)	LUMENS @ 6500K (lm)	CUT-OUT (mm)	COLOUR
19761/05	13	820	920	820	120	White
19762/05	15	1150	1300	1150	140	White
19763/05	18	1300	1500	1300	160	White
19764/05	24	1800	2000	1800	200	White

# EXPANDA

## TWIN LED WORKLIGHT WITH TRIPOD



**40W LED**  
3600lm

**4200K**  
COOL  
WHITE

**IP54**  
RATING



**3YR**  
WARRANTY

- Portable rugged design tripod worklight.
- Durable diecast aluminium light sources with steel tripod/stand.
- Energy saving SMD LED.
- Super bright 2 x 20W/1800lm light sources.
- Convenient head tilt.
- Swivel tripod for maximum light coverage.
- 1.6m telescopic tripod.
- IP54 Weather-resistant rated.
- 3m power cord and 3-Pin plug.
- Weight: 4.76kg.

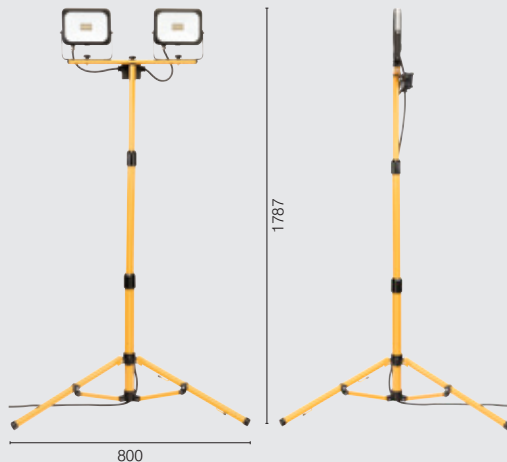

MODEL NO.	COLOUR
19902/06	Black / Yellow

# PORTALAMP-II

## RECHARGEABLE LED FLOODLIGHT



<b>10W LED</b> 900lm	<b>Battery</b> Li-on 2200mAh	<b>20W LED</b> 1800lm	<b>Battery</b> Li-on 4400mAh	<b>6200K</b> COOL WHITE	<b>IP44</b> RATING	<b>DIY</b>
20263/02		20264/02				

- Rechargeable Li-ION battery.
- Durable die cast aluminium housing.
- Battery power indicator.
- Dimmable light output.
- IP44 weather resistant.
- Charging time: 4-5 hours.
- Working time: 2.5 hours.

### INCLUDES

- 12V DC, car charger
- 240V AC SAA approved charger



MODEL NO.	WATTAGE (W)	LUMENS (lm)	COLOUR
20263/02	10	900	Yellow
20264/02	20	1800	Yellow



**BREAKDOWNS**

**OUTDOORS**

**RENOVATIONS**

**AUTOMOTIVE**

**BOATING**

**CONSTRUCTION**





# ELECTRICAL

Brilliant has a complementary  
electrical range of solutions  
for the trade, retail and DIY



# SMART ELECTRICAL RANGE



**SMART WIFI DIMMER MECH**  
20967



**SMART WIFI RELAY MECH SWITCH**  
21322



**JUPITER SMART WIFI/RF DIMMER CONNECTOR –** 20693/05



ONLY WORKS IN CONJUNCTION WITH RF/WIFI JUPITER SMART WIFI DIMMER MODULE

**KINETIC RF DIMMING SWITCH**  
1 GANG, 2 GANG, 3 GANG  
20758/05, 20759/05, 20760/05



**FOX SMART WIFI FOX RELAY CONTROLLER**  
20694/05



**ELITE SMART WIFI GLASS WALL SWITCH**  
1 GANG, 2 GANG, 3 GANG, 4 GANG  
20681/05, 20683/05, 20685/05, 20687/05



**GARAGE DOOR CONTROLLER**  
21456



**ELECTRIC DOOR CONTROLLER**  
21457

WiFi  
**NO HUB  
REQUIRED**

Have full control of your smart devices  
via the BrilliantSmart App, or via  
voice control with Google and Alexa.



**SMART PLUG WITH USB CHARGER**  
20676/05



**SMART POWERBOARD WITH USB  
CHARGER – 20691/05**



**LED STRIP CONTROLLER**  
20794

Go to the BrilliantSmart section  
on page 6 for more info or visit:

**brilliantlighting.com.au**  
or **brilliantsmart.com.au**



# DUAL USB

## POP-UP CHARGER

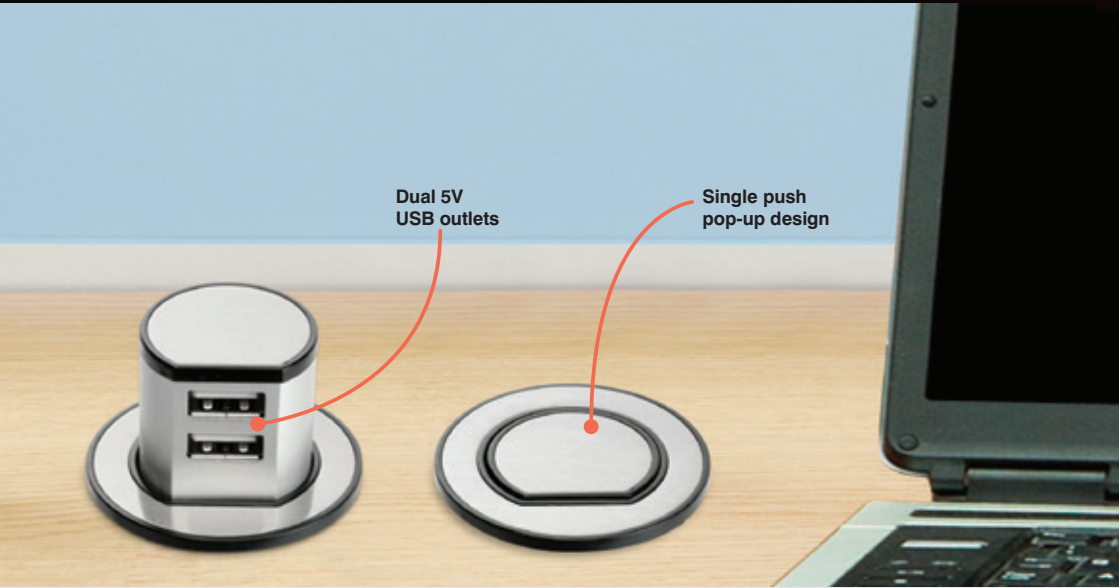

- Pop-up design.
- 2 x 5V USB2.0 outlets (2400mA Max).
- DIY installation, complete with 240V to 12V plug pack adapter and 2m cable.

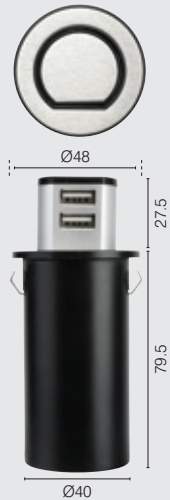

MODEL NO.	VOLTAGE (V)	CURRENT (MA)	COLOUR
20227/13	5	2400	Satin Nickel



# POWERSTATION

DESKTOP POWER STATION WITH BLUETOOTH® SPEAKER



- 2 x 240V sockets.
- Separately switched 2 x USB2.0 outlets (2400mA max).
- DIY installation (screws included), complete with 1.6m flex & plug.
- Bluetooth speaker with 3-5mm auxiliary input jack.



MODEL NO.	PRODUCT	POWER SOCKET (A)	USB SOCKET (MA)	COLOUR
20230/11	POWERSTATION	10	2400	Silver

# POWERBOARD

## BENCH TOP POWER SOLUTION



- Pull-up/push down design.
- 2 x Australian standard power sockets.
- Separately switched 2 x USB2.0 outlets (2400mA max).
- IP54 water-resistant rating for use in kitchens (when in closed position).
- DIY installation, complete with 1m flex & plug.
- Adjustable collar suits 10–55mm thick bench tops.



MODEL NO.	POWER SOCKET (A)	USB SOCKET (MA)	COLOUR
20233/06	10	2400	Black

# POWERBOARD

PREMIUM BENCH TOP POWER SOLUTION



240V  
10A  
MAX

↑  
x3

USB  
x2

IP54  
RATING

Ø95mm

DIY

2YR  
WARRANTY

- Pull-up/push down design.
- 3 x Australian standard power sockets.
- 2 x separately switched USB2 outlets (2100mA max).
- IP54 water-resistant rating for use in kitchens (when in closed position).
- DIY installation, complete with 1m flex & plug.
- Adjustable collar suits 10–55mm thick bench tops.
- Overload protection.



MODEL NO.	POWER SOCKET (A)	USB SOCKET (MA)	COLOUR
18878/13	10	2100	Satin Nickel

# DIMMERS

## UNIVERSAL



- Dimming: 2% to 100%\*.
- Design & optimised for dimmable LED lamps & fittings.
- Fits into standard Clipsal® & HPM® branded wall plates.
- 2 wire design - suitable for lamps & most standard wiring fittings\*.
- Suitable for most dimmable 240V, 12V lamp sources including GU10, MR16, GX54, G4 fittings\*.
- Also works with most magnetic or electronic transformers\*.
- Soft start for improved lamp life.
- Detects the load type and selects either leading or trailing edge as required.

\*Load dependent. Final performance may vary according to actual LED globe and transformer/driver used. Must be installed by a licensed electrician. Not suitable for fans and other inductive loads.

MODEL NO.	COLOUR	DESCRIPTION
18829/05	White	Rotary

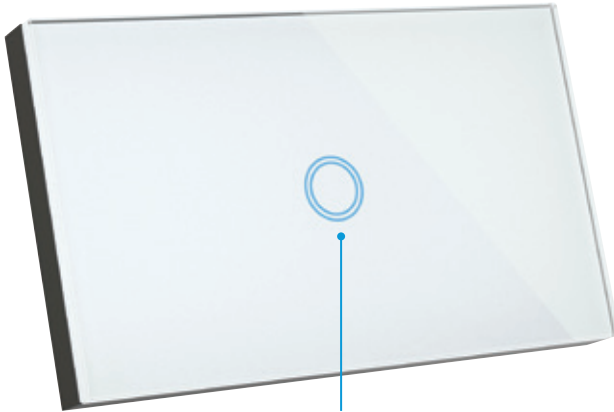

Blue 'On'

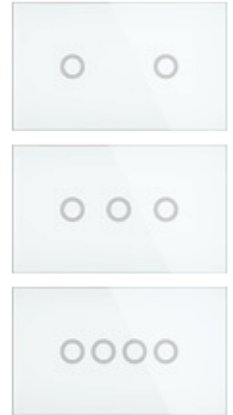

- Designer tempered glass wall plate.
- Touch ON/OFF control.
- Blue LED indicator when on.
- Max load: 500W Incandescent, 150W LED per gang.
- Installation: Fits standard plaster/stud brackets (84mm centres).
- Wiring: 20m<sup>2</sup> terminals, suitable for 2.5mm cables  
Requires neutral for operation (3 wires design).
- Operating voltage 240V 50Hz.

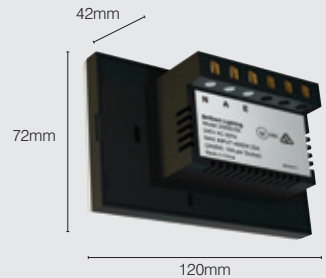

MODEL NO.	COLOUR	DESCRIPTION
20682/05	White	1 Gang
20684/05	White	2 Gang
20686/05	White	3 Gang
20688/05	White	4 Gang

# KINETIC DOORBELL

WIRELESS – NO BATTERIES



## A compact and completely wireless doorbell to suit front or back doorways.

- Kinetic technology generates power on each press.
- Up to 30m operating distance from kinetic doorbell to chime plug.
- 4 adjustable volume levels.
- Push the doorbell and hear the chime inside your home. Up to 38 chimes to choose from.
- Receiver plugs directly into mains power for easy wireless installation.

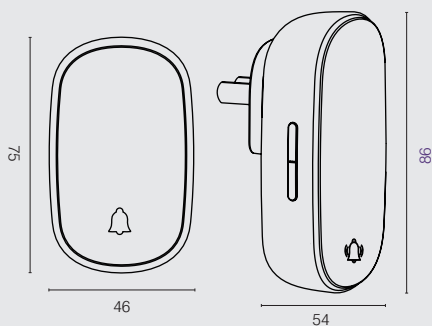

MODEL NO.	COLOUR
21459	White

# HEAT ZONE

## PATIO HEATER



**240V  
50Hz  
MAX**

**1500W**

20802/06

**2000W**

20803/06

**IPX4  
RATING**



**2YR  
WARRANTY**

Superior close proximity outdoor heating, suitable for a wide range of applications, including alfresco dining areas, patios, beer gardens, balconies, outdoor gaming rooms and sidewalk cafes.

- Produces infrared heat directly warming people and objects in its path.
- No energy wasted trying to heat the air that can blow away.
- Made from durable high grade anodised aluminium.
- Specifically designed for outdoor heating applications.
- Instant infrared heat element
- Ceiling mount, includes a 0.6m hanging chain and hook.
- IPX4 weatherproof rating ensures the heater can be exposed to some weather elements.
- DIY installation, complete with 1.9m 10 Amp flex & plug.
- Turn on via pull cord switch.

### INSTALLATION SAFE DISTANCES

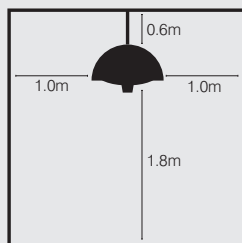

MODEL NO.	WATTAGE	CURRENT	WEIGHT	HEATING AREA
20802/06	1500	6.3 Amps	2.5 kg	3-4m <sup>2</sup>
20803/06	2000	8.3 Amps	3.5 kg	4-5m <sup>2</sup>







# EMERGENCY

Brilliant's extensive range of  
emergency lighting products suits  
office, industrial or commercial space

# EMERGENCY

## OPERATING MODES



### NON-MAINTAINED MODE

A luminaire in which all the emergency lamps are in operation only when the normal mains supply fails, ie the lamps are normally OFF when the mains supply is on, and come ON in emergency when the mains supply fails.



### MAINTAINED MODE

A luminaire in which all the emergency lamps are in operation at all times, ie the lamps are ON when the mains supply is on, and remain ON in emergency mode when mains supply fails.



### SUSTAINED MODE

An emergency luminaire containing two or more lamps, at least one of which is energised from a non-maintained emergency lighting supply. The remaining lights are energised and lit from the normal mains supply.

Usually, one lamp is ON when the mains supply is on, and the other lamp will come ON when the mains supply fails.

## EMERGENCY LIGHTING STANDARDS

AS2293 *Emergency escape lighting and exit signs for buildings*

### Pictograph

A moving person commonly known as "Running Man" is used to indicate an exit. Three common variations cover all possibilities.



## VIEWING DISTANCE

The standards define viewing distance in relation to the sizes of the pictograph and the arrow.

*Accepted standard sizes to the left*

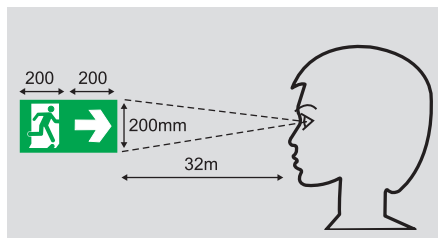
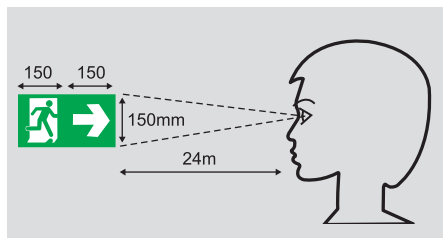

**Note:** For additional information refer to Standards Australia. [www.standards.org.au](http://www.standards.org.au)

LUMINAIRE CLASSIFICATION		MOUNTING HEIGHTS IN METRES ABOVE FLOOR																	
Classifications	Lux	2.1	2.4	2.7	3.0	3.3	3.6	4.0	4.5	5.0	6.0	7.0	8.0	9.0	10.0	15.0	20.0		
C2	0.20	4.1	4.1	4.1	3.9	3.7	3.3	2.6											
C12.5	0.20	7.8	8.2	8.6	8.9	9.2	9.5	9.8	10.0	10.2	10.3	10.1	9.4	8.3	6.5				
	1.00	4.5	4.6	4.6	4.5	4.4	4.1	3.4	2.1										
C80	0.20	12.7	13.5	14.4	15.1	15.8	16.5	17.3	18.3	19.1	20.7	22.0	23.0	23.9	24.7	26.1	24		
	1.00	8.3	8.8	9.2	9.6	10.0	10.3	10.6	11	11.3	11.6	11.6	11.3	10.6	9.2				
D3.2	0.20	6.5	6.6	6.6	6.5	6.4	6.2	5.8	5.1	4.1									
	1.00	1.8																	
D4	0.20	7.2	7.3	7.3	7.3	7.3	7.2	6.9	6.5	5.8	3.1								
	1.00	2.7	1.9																
D5	0.20	7.8	8.0	8.1	8.2	8.2	8.2	8.0	7.7	7.3	5.7	1.6							
	1.00	3.3	3.0	2.0	1.1														
D6.3	0.20	8.6	8.8	9	9.1	9.2	9.2	9.2	9.0	8.7	7.7	5.7							
	1.00	3.9	3.7	3.3	2.4	1.5													
D10	0.20	10.2	10.6	10.9	11.1	11.3	11.4	11.5	11.6	11.6	11.2	10.3	8.9	6.7					
	1.00	5.1	5.1	4.9	4.7	4.3	3.7	2.4											
D12.5	0.20	11.1	11.5	11.8	12.1	12.4	12.5	12.7	12.9	13.0	12.8	12.3	11.3	9.9	7.6				
	1.00	5.7	5.7	5.6	5.5	5.3	5.0	4.3	2.6										
D16	0.20	12.1	12.6	13	13.3	13.6	13.9	14.1	14.6	14.6	14.6	14.4	13.8	12.9	11.5				
	1.00	6.4	6.5	6.5	6.4	6.3	6.1	5.7	5.0	3.2									
D20	0.20	13.1	13.6	14.1	14.5	14.8	15.1	15.5	15.8	16.1	16.4	16.3	16.0	15.4	14.5				
	1.00	7.1	7.2	7.2	7.2	7.2	7.1	6.8	6.4	5.7	2.2								
D25	0.20	14.2	14.7	15.3	15.7	16.1	16.5	16.9	17.3	17.7	18.1	18.3	18.2	17.9	17.3	7.7			
	1.00	7.7	7.9	8.0	8.1	8.1	8.1	7.9	7.6	7.2	4.8	1.1							
D32	0.20	15.4	16.1	16.7	17.2	17.6	18.0	18.5	19.1	19.5	20.2	20.6	20.7	20.6	20.3	14.6			
	1.00	8.5	8.8	9.0	9.1	9.2	9.2	9.2	9	8.7	7.7	4.7							
D40	0.20	16.7	17.4	18.0	18.6	19.1	19.6	20.1	20.8	21.3	22.1	22.7	23.0	23.1	23.1	19.4			
	1.00	9.3	9.6	9.8	10.0	10.1	10.2	10.3	10.2	10.1	9.4	8.2	4.8						
D50	0.20	18	18.7	19.4	20.1	20.7	21.2	21.8	22.5	23.2	24.2	24.9	25.4	25.7	25.9	23.7	15.2		
	1.00	10.1	10.5	10.8	11.0	11.2	11.3	11.4	11.5	11.5	11.1	10.2	8.6	5.2					
D63	0.20	19.4	20.3	21.1	21.8	22.4	23	23.7	24.5	25.2	26.4	27.4	28.1	28.6	28.9	28.0	22.5		
	1.00	11	11.4	11.8	12.1	12.3	12.5	12.7	12.8	12.9	12.8	12.2	11.3	9.6	6.1				
E1.6	0.20	4.8	4.8	4.8	4.4	4.0	4.2	3.8											
E2.0	0.20	5.2	5.2	5.4	5.2	5.0	4.6	4.8	4.0										
E2.5	0.20	5.6	5.8	5.8	6.0	5.8	5.8	5.2	5.2	4.6									
E4.0	0.20	6.2	6.6	7.0	7.2	7.4	7.4	7.4	7.2	6.6	7.0								
E5.0	0.20	6.6	7.2	7.4	7.8	8.0	8.2	8.4	8.4	8.2	7.0	6.8							
E10.0	0.20	7.8	8.4	9.0	9.4	9.8	10.2	10.8	11.2	11.4	11.8	11.6	10.2	10.4	9.2				
	1.00	5.0	5.1	5.2	5.1	4.9	3.8	2.7											
E12.5	0.20	8.0	8.8	9.4	10.0	10.4	11.0	11.4	12.0	12.4	13.0	13.2	12.8	11.4	11.6				
	1.00	5.4	5.6	5.7	5.8	5.7	5.6	4.3	2.9										

- (1) Maximum spacings for mounting heights between the values given in the table may be obtained by interpolation.
- (2) Refer to AS2293.3 for details regarding classification of luminaires
- (3) 0.20 lux refers to Australian Standards
- (4) 1.00 lux refers to New Zealand Standards.

# BLADE

## LED EMERGENCY EXIT SIGN

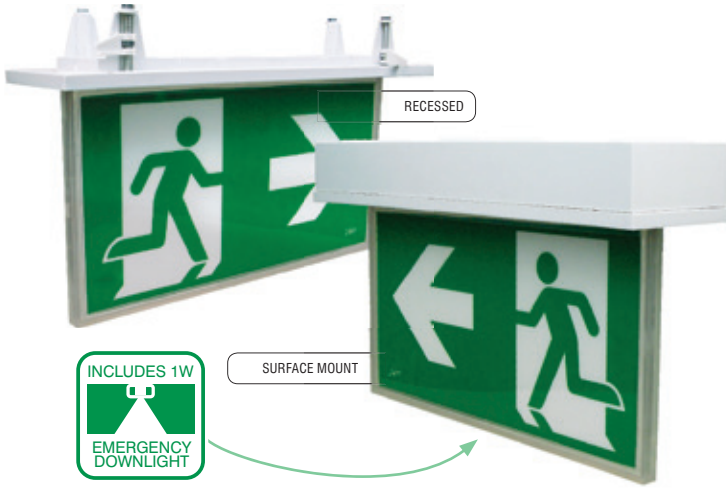

PICTOGRAMS INCLUDED



BLACK AVAILABLE



240V  
50Hz

5W  
TOTAL  
WATTAGE

CRI  
> 83

E5.0  
C0

E2.0  
C90

3YR  
WARRANTY

- Compliant to AS/NZS 2293.
- IP20 rating.
- 50,000 Hour average life rated LED modules.
- Recessed & surface mount options.
- Injection moulded polycarbonate housing and acrylic diffuser with pictogram legends.
- Viewing distance 24m.
- High density storage LiCoO<sub>2</sub> batteries.
- Diffuser & pictogram inserts included.
- Cutout 80 x 320mm (recessed).
- Additional 1W Non-Maintained downlight during mains power outage.
- Fully tested & compliant with Australian Standards.

- 2 Hour duration period.
- TA40-maximum thermal ambient operating temperature.
- Charger type: Trickle.
- Charger time: 16 Hours.
- Charger operation: Continuous.

### APPLICATIONS

Commercial office areas, hotels, shopping, apartments & hospitals.

For classification and spacing distances, see table on page 91.

MODEL NO.	COLOUR	MOUNT TYPE	MAINTAINED LAMP WATTAGE (W)	NON-MAINTAINED LAMP WATTAGE (W)
19878/05	White	Recessed	2	1
19878/06	Black			
19880/05	White	Surface	2	1
19880/06	Black			
19893/05	White	Surface Mount Box Only		
19893/06	Black			

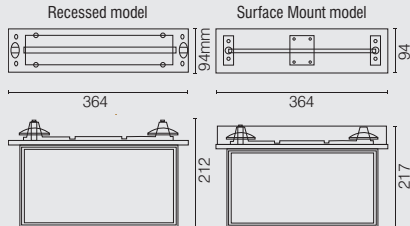

\* Note: Surface mount version shipped in two boxes.



PICTOGRAMS INCLUDED



BLACK AVAILABLE



**240V**  
**50Hz**

**5W**  
TOTAL  
WATTAGE

**CRI**  
**>80**

**E2.0**  
**C90**

**E1.6**  
**C90**

**3YR**  
WARRANTY

- Compliant to AS/NZS 2293.
- IP20 rating.
- 50,000 Hour average life rated LED modules.
- Surface-mount ceiling or wall.
- Injection moulded polycarbonate housing and acrylic diffuser with pictogram legends.
- Viewing distance 24m.
- High density storage LiCoO<sub>2</sub> batteries.
- Diffuser & pictogram inserts included.
- 2 Hour duration period.
- TA40 - maximum thermal ambient operating temperature.
- Charger type: Trickle.
- Charger time: 16 Hours.
- Charger operation: Continuous.

### APPLICATIONS

Doorways, stairways, corridors and intersections on an emergency escape route.

For classification and spacing distances, see table on page 91.

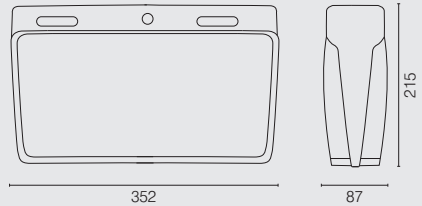

MODEL NO.	COLOUR	MAINTAINED LAMP WATTAGE (W)	NON-MAINTAINED LAMP WATTAGE (W)
19874/05	White	2	-
19874/06	Black		

# ONE-BOX

## LED EXIT SIGN WITH EMERGENCY DOWNLIGHT



PICTOGRAMS INCLUDED



<b>240V</b> <b>50Hz</b>	<b>5W</b> TOTAL WATTAGE	<b>CRI</b> <b>&gt; 80</b>	<b>E12.5</b> C0/C90	<b>3YR</b> WARRANTY
----------------------------	-------------------------------	------------------------------	------------------------	------------------------

- Compliant to AS/NZS 2293.
- IP20 rating.
- 50,000 Hour average life rated LED modules.
- Surface-mount ceiling or wall.
- Injection moulded polycarbonate housing and acrylic diffuser with pictogram legends.
- Viewing distance 24m.
- High density storage LiCoO<sub>2</sub> batteries.
- Diffuser & pictogram inserts included.
- Additional 1W non-maintained downlight during mains power outage.
- 2 Hour duration period.
- TA40 - maximum thermal ambient operating temperature.
- Charger type: Trickle.
- Charger time: 16 Hours.
- Charger operation: Continuous.

### APPLICATIONS

Doorways, stairways, corridors and intersections on an emergency escape route.

For classification and spacing distances, see table on page 91.

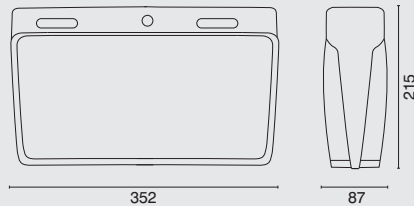

MODEL NO.	COLOUR	MAINTAINED LAMP WATTAGE (W)	NON-MAINTAINED LAMP WATTAGE (W)
19876/05	White	2	1



**240V**  
**50Hz**

**28W**  
**LED**  
**2100lm**

**6W**  
**SUSTAIN**  
**LAMP**

**4200K**  
**COOL**  
**WHITE**

**IP65**  
**RATING**

**CRI**  
**> 80**

**IK08**

**D40**

**3YR**  
**WARRANTY**

19987

- Also available in Non-emergency
- IP65 rating.
- Compliant to AS/NZS 2293.
- Big bore terminal block.
- Vandal-resistant IK08 rated.
- Energy efficient high output 28 watt LED.
- Surface ceiling mount.
- Non-dimmable.
- Injection moulded polycarbonate housing.
- D40/D40 classification.
- High density storage LiCoO<sub>2</sub> (3600mAh) batteries.
- 3 Hour duration period.
- TA40 - maximum thermal ambient operating temperature.
- Charger type: Trickle.
- Charger time: 16 Hours.
- Charger operation: Continuous.

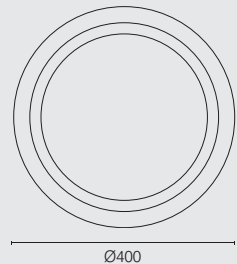

### APPLICATIONS

Wet rooms, commercial and interior applications, coastal environment, apartments, shopping centres, hospitality, prisons and hospitals.

MODEL NO.	COLOUR	DESCRIPTION
19987/05	White	Emergency Model
19989/05	White	Non-Emergency Model

For classification and spacing distances, see table on page 91.



- Compliant to AS/NZS 2293.
- D20/D20 classification.
- Mounting bracket for easy installation.
- Energy efficient high output 35 watt LED.
- Surface ceiling mount.
- Non-dimmable.
- Aluminium base with opal polycarbonate diffuser.
- High density storage LiCoO<sub>2</sub> (3600mAh) batteries.
- 3 hour duration period.
- Charger type: trickle.
- Charger time: 16 hours.
- Charger operation: Continuous.

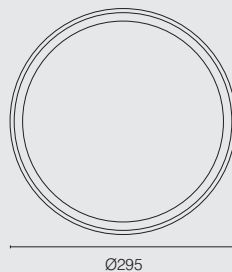
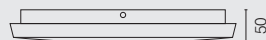

### APPLICATIONS

Commercial and interior applications, apartments, shopping centres, hospitality, prisons and hospitals.

MODEL NO.	COLOUR	DESCRIPTION
19986/05	White	Emergency Model

For classification and spacing distances, see table on page 91.





- Compliant to AS/NZS 2293.
- D32/D32 classification.
- Big bore terminal block.
- Energy efficient high output 28 watt LED.
- Ceiling surface mount.
- Non-dimmable.
- Metal base with opal acrylic diffuser.
- High density storage LiCoO<sub>2</sub> (3600mAh) batteries.
- 3 Hour duration period.
- Charger type: Trickle.
- Charger time: 16 Hours.
- Charger operation: Continuous.

### APPLICATIONS

Commercial and interior applications, apartments, shopping centres, hospitality and hospitals.

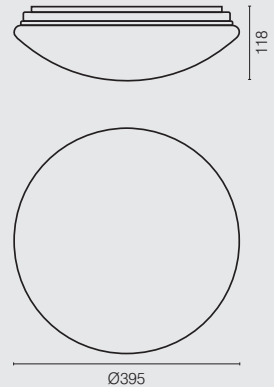

MODEL NO.	COLOUR	DESCRIPTION
19892/05	White	Emergency Model

For classification and spacing distances, see table on page 91.

# PATHFINDER

## 3W LED EMERGENCY LUMINAIRE



- Compliant to AS/NZS 2293.
- IP20 rating.
- Energy efficient high output 3 watt LED.
- 2-Pin flex & plug included.
- Recessed or ceiling surface mount options available.
- Fully self contained control circuit.
- Injection moulded polycarbonate housing.
- Removeable large trim ring included.
- D40/D40 classification.
- High density storage LiCo<sub>2</sub> batteries.
- 2 Hour duration period.
- TA40 - maximum thermal ambient operating temperature.
- Charger type: Trickle.
- Charger time: 16 Hours.
- Charger operation: Continuous.
- Cutout: 70 to 130mm.

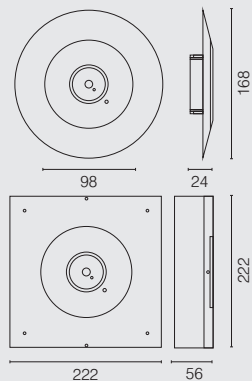

### APPLICATIONS

Commercial and interior applications, coastal environment, apartments, shopping centres, hospitality, prisons and hospitals.

For classification and spacing distances, see table on page 91.

MODEL NO.	COLOUR	MOUNT TYPE	NON-MAINTAINED LAMP WATTAGE (W)
19882/05	White	Recessed	3
19882/06	Black		3
19886/05	White	Surface	3
19895/05	White	Surface Mount Box Only	

# PATHFINDER

## 6W LED EMERGENCY LUMINAIRE



- Compliant to AS/NZS 2293.
- IP20 rating.
- Energy efficient high output 6 watt LED.
- 2-Pin flex & plug included.
- Recessed or ceiling surface mount options available.
- Injection moulded polycarbonate housing.
- 2 pin flex and plug included.
- Removeable large trim ring included.
- D63/D63 classification.
- High density storage LiCoO<sub>2</sub> batteries.
- 2 Hour duration period.
- TA40 - maximum thermal ambient operating temperature.
- Charger type: Trickle.
- Charger time: 16 Hours.
- Charger operation: Continuous.
- Cutout: 70 to 130mm.

### APPLICATIONS

Commercial and interior applications, coastal environment, apartments, shopping centres, hospitality, prisons and hospitals.

For classification and spacing distances, see table on page 91.

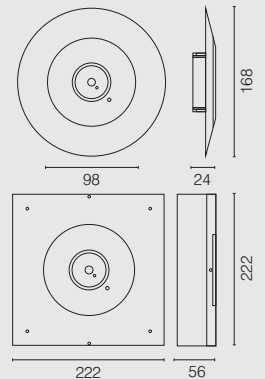

MODEL NO.	COLOUR	MOUNT TYPE	NON-MAINTAINED LAMP WATTAGE (W)
19884/05	White	Recessed	6
19888/05	White	Surface	6
19888/06	Black		
19895/05	White	Surface Mount Box Only	

# PATHFINDER

## IP65 6W LED EMERGENCY LUMINAIRE



- Compliant to AS/NZS 2293.
- IP65 rating.
- Energy efficient high output 6 watt LED.
- Big bore terminal block.
- Ceiling surface mount.
- Injection moulded polycarbonate housing.
- D40/D40 classification.
- High density storage LiCoO<sub>2</sub> batteries.
- CRI >80.
- 2 Hour duration period.
- Charger type: Trickle.
- Charger time: 16 Hours.
- Charger operation: Continuous.

### APPLICATIONS

Wet rooms, commercial and interior applications, coastal environment, apartments, shopping centres, hospitality, prisons and hospitals.

For classification and spacing distances, see table on page 91.

MODEL NO.	MOUNT TYPE	NON-MAINTAINED LAMP WATTAGE (W)	COLOUR
20217/05	SURFACE	6	White

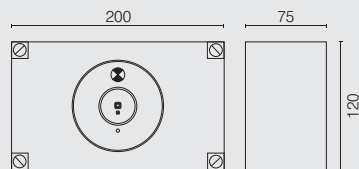



19992  
ONLY

**• Also available in Non-Emergency**

- Compliant to AS/NZS 2293.
- C0: D25; C90: D63 classifications.
- Corrosion resistant, IP65 weatherproof polycarbonate body.
- Vandal-resistant IK08 rated.
- UV stabilised high impact polycarbonate cover.
- Stainless steel mounting brackets for easy installation.
- Ceiling mount.
- High density storage LiCoO<sub>2</sub> (3600mAh) batteries.
- 2 Hour duration period.
- Charger type: Trickle.
- Charger time: 16 Hours.
- Charger operation: Continuous.

**APPLICATIONS**

Wet rooms, commercial and interior applications, coastal environment, apartments, shopping centres, car parks, stairwells, hospitality, prisons and hospitals.

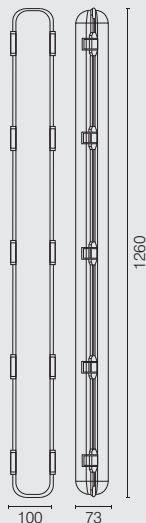

For classification and spacing distances, see table on page 91.

MODEL NO.	COLOUR	DESCRIPTION
19992/08	Grey	Emergency Model
19998/08	Grey	Non-Emergency Model





# CEILING FANS

Brilliant's extensive range of energy efficient ceiling fans and fan accessories not only keep living and working areas cool in warmer months – they also add style to any room

# BAHAMA

## SMART WIFI DC CEILING FAN



2.4 GHz



- Steel body and canopy construction
- 3 x moulded ABS blades
- Ceiling rake 14 degree maximum
- Fan drop 375mm
- 5 speed remote control with reverse function and timer
- Light: 18W 1000lm LED non-dimmable (CCT switchable from remote control)
- For indoors or enclosed alfresco areas not exposed to the weather
- Smart mode: nature, normal, sleep and wake up (app only)

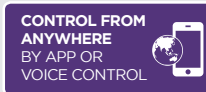
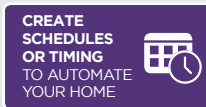

Smart phone not included

SWITCH TO ADJUST COLOUR TEMPERATURE

WARM WHITE >

COOL WHITE >

DAYLIGHT

### ACCESSORIES

#### EXTENSION RODS WITH LOOM KITS (sold separately)

- 900mm x Ø21mm  
20252/06 matt black, 100550/05 white



Visit [brilliantsmartcomau](http://brilliantsmartcomau) to find out more on our smart device range

MODEL NO	COLOUR	DESCRIPTION	SPEED	POWER	RPM	AIRFLOW
20918/05	Matt white with white blades	Fan with light	5	31W	195	9328 m <sup>3</sup> /hr
20918/37	Matt white with whitewashed timber blades	Fan with light	4	19W	168	7985 m <sup>3</sup> /hr
20918/06	Matt black with black blades	Fan with light	3	13W	150	6455 m <sup>3</sup> /hr
20918/51	Matt black with maple timber blades	Fan with light	2	8W	120	5230 m <sup>3</sup> /hr
			1	5W	87	3369 m <sup>3</sup> /hr



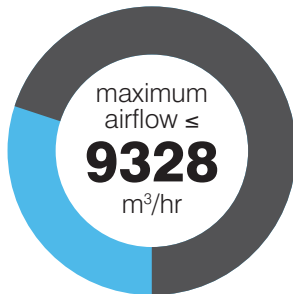

Program your ceiling fan and/or light to turn ON/OFF automatically



Remote Included

**32W**  
DC MOTOR

**14°**  
BLADE  
PITCH

**52 INCH**  
1320mm

**6YR**  
WARRANTY

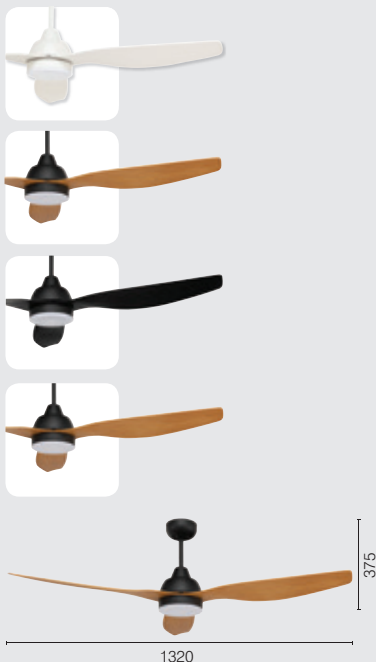

### Smart Features

BrilliantSmart fans and remotes offer all the features of a traditional fan (such as the speed and light control or the summer/winter modes), but they also come packed full of extra features.

**SLEEP MODE** enables you to set a personalised night-time comfort, setting the fan to its lowest speed.

**NATURE MODE** varies the fan speed to mimic a cooling breeze effect.

**WAKE UP MODE** acts as a cool way to wake you up during sleep. The fan and light will turn ON with the fan speed gradually increasing every 5 minutes until it reaches its maximum speed.

Create **SCHEDULES** or **TIMERS** to turn your fan ON and OFF automatically, to help cool or warm your home before you get home.

**AUTOMATE** the fans operation by setting triggers for humidity, temperature or weather conditions. This way, the ceiling fan can turn ON or OFF and adjust its speed and direction depending on the room temperature in order to rotate the air and keep your room cooler in the summer and warmer in the winter – this helps a lot with the energy bill.

**PAIRING** with other BrilliantSmart products, like sensors to detect movement to turn the light or fan ON or OFF when you enter or leave the house.

# ADVANTAGES OF DC MOTOR CEILING FANS

## High Efficiency

Ceiling fans with DC motors create a higher torque, meaning greater initial power and less energy consumption. DC motors consume up to 58% less energy than conventional AC ceiling fan motors.

---

## Greater Control

DC motor control provides up to six speed settings and an easy to use reversing function for summer and winter operation. These motors are easier to start, stop and accelerate.

---

## Light Weight

DC motors weigh less than conventional AC fan motors, resulting in a lighter product that is easier to install.

---

## Quiet Operation

DC motors are virtually silent, ensuring a quiet operation.

---

## Warranty

Brilliant Lighting (Aust) Pty Ltd warrants the ceiling fan motor for a period of 6 years from the date of purchase – the first 3 years are covered by in-home warranty.

All parts deemed defective in workmanship or materials, will be replaced free-of-charge.

Remote controllers, wall controllers, and light fittings are subject to limited warranty status.

Parts	Total Warranty Period	In-home Service Period
Ceiling fan motor	6 years	3 years
Wall controller	2 years	2 years
Remote controller set	2 years	2 years
Light fittings	2 years	2 years

*Consumable items such as batteries and light globes will not be covered by this warranty.*



## Installation conditions/warranty

Warranty on fans is 6 years which includes 3 year in-home + additional 3 years on the motor.

The warranted use of fans outdoors are limited to Enclosed Alfresco like areas where conditions are similar to indoor installations

The warranty conditions for fans installed in Enclosed Alfresco areas are as follows:

- Fan must be shielded from wind and rain (enclosed area, minimum 15m from edge of eave/roof).
- The warranty will cover open circuit motor faults, and remote control faults if not related to outdoor exposure.
- The Warranty will not cover outdoor related issues such as rusting, or failure clearly caused by water, moisture or wind.
- The Warranty will not cover external appearance or finish of any part of the ceiling fan.
- The Warranty will not cover wooden blades. These are recommended only to be used indoors.

---

## What is Airflow

The performance of Ceiling Sweep Fans is often expressed in cubic meters per hour. This quantifiable unit shows how much volume of air is pushed from the fan blades past the measurement point per hour.

The airflow is directly related to the area of the blade span (and other factors such as blade pitch and rpm) so larger bladed fans tend to have much higher airflow than the smaller fans.

It is important to realise that higher airflow does not necessarily equate to higher air speeds and that the perception of high volumetric airflow is not as noticeable as air speed on the skin's surface.

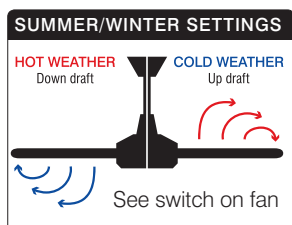

Brilliant's all-seasons technology is for use all year round.

Summer mode – blades rotate clockwise to push cool air down.

Winter mode – blades rotate anti-clockwise at a low speed. A gentle updraft pushes warm air down along the walls to the floor.

Note: All energy saving and air movement data is produced by an accredited test lab. In home results may vary depending on circumstances and installation.

# AVIATOR

## DC CEILING FAN – 66 INCH

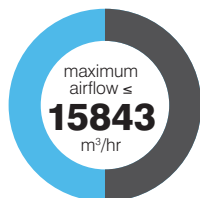

**35W**  
DC MOTOR

**25°**  
BLADE  
PITCH

**66IN**  
1670mm

**6YR**  
WARRANTY

- Metal body and canopy construction
- 6 x durable moulded ABS blades
- Ceiling rake 25 degree maximum
- Fan drop 465mm and 490mm with light
- 6 speed remote control with light on/off & reverse function
- Light kit included – 2 x 15W max E27 (globes not included)
- For indoors or enclosed alfresco areas not exposed to the weather



### EXTENSION RODS WITH LOOM KITS (sold separately)

- 900mm x Ø26mm  
18627/05 matt white, 18627/14 oil-rubbed bronze
- 1800mm x Ø26mm  
18769/05 matt white

SPEED	POWER	RPM	AIRFLOW
6	35W	93	15843 m <sup>3</sup> /hr
5	23W	79	12810 m <sup>3</sup> /hr
4	14W	66	10999 m <sup>3</sup> /hr
3	9W	55	9463 m <sup>3</sup> /hr
2	6W	43	7822 m <sup>3</sup> /hr
1	4W	31	5965 m <sup>3</sup> /hr

MODEL NO	COLOUR	DESCRIPTION
18516/05	White	Fan only
18516/14	Oil-rubbed bronze	

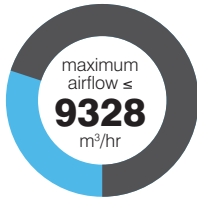

Remote  
Included

**32W**  
DC MOTOR

**14°**  
BLADE  
PITCH

**52IN**  
1320mm

**6YR**  
WARRANTY

- Metal body and canopy construction
- 3 x durable moulded ABS blades
- Ceiling rake 17 degree maximum
- Fan drop 320mm
- 5 speed remote control with reverse function and timer
- For indoors or enclosed alfresco areas not exposed to the weather



### EXTENSION RODS WITH LOOM KITS (sold separately)

- 900mm x Ø21mm  
100550/05 white, 20252/06 matt black,  
100550/06 matt black



MODEL NO	COLOUR	DESCRIPTION
19587/05	Matt White	Fan only
19587/06	Matt Black	
19587/37	White/whitewashed timber	
19587/51	Charcoal/Maple	

SPEED	POWER	RPM	AIRFLOW
5	31W	185	9328 m <sup>3</sup> /hr
4	19W	168	7985 m <sup>3</sup> /hr
3	13W	150	6455 m <sup>3</sup> /hr
2	8W	120	5230 m <sup>3</sup> /hr
1	5W	87	3369 m <sup>3</sup> /hr

# CANYON

## DC CEILING FAN – 56 INCH

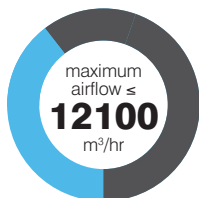

**40W**  
DC MOTOR

**20°**  
BLADE  
PITCH

**56IN**  
1420mm

**6YR**  
WARRANTY

- Steel body and canopy construction
- 3 x moulded durable ABS blades
- Ceiling rake 14 degree maximum
- Fan drop 350mm
- 5 speed remote control with reverse function
- For indoors or enclosed alfresco areas not exposed to the weather



### EXTENSION RODS WITH LOOM KITS (sold separately)

- 900mm x Ø21mm  
100550/05 white, 20252/06 matt black,  
100550/06 matt black



MODEL NO	COLOUR	DESCRIPTION
20896/05	Matt White	Fan only
20896/06	Matt Black	
20896/51	Matt Black with Oak	

SPEED	POWER	RPM	AIRFLOW
5	40W	190	12,100 m <sup>3</sup> /hr
4	24W	168	10,150 m <sup>3</sup> /hr
3	16W	155	8180 m <sup>3</sup> /hr
2	1W	115	4500 m <sup>3</sup> /hr
1	8W	80	2360 m <sup>3</sup> /hr

# CONCORDE II

DC CEILING FAN – 58 INCH

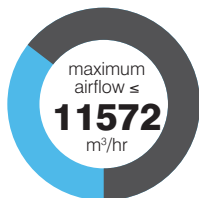

Remote  
Included



<b>35W</b> DC MOTOR	<b>13°</b> BLADE PITCH	<b>58IN</b> 1470mm	<b>IP44</b> RATING	<b>6YR</b> WARRANTY
------------------------	------------------------------	-----------------------	-----------------------	------------------------

- Diecast aluminium body and metal canopy construction
- 3 x moulded durable ABS blades
- Ceiling rake 14 degree maximum
- 6 speed remote control with reverse function and light on/off
- Optional light kit – 15W 750lm 4200K LED
- IP44 rated – for indoors or enclosed alfresco areas not exposed to the weather



#### FAN LIGHT KIT (sold separately)

- 20071/05 white, 20071/06 matt black



#### EXTENSION RODS WITH LOOM KIT (sold separately)

- 900mm x Ø21mm  
20265/05 white, 20265/06 black



SPEED	POWER	RPM	AIRFLOW
6	30W	185	11572 m <sup>3</sup> /hr
5	11W	112	7526 m <sup>3</sup> /hr
4	8W	97	6463 m <sup>3</sup> /hr
3	6W	80	5027 m <sup>3</sup> /hr
2	5W	65	4086 m <sup>3</sup> /hr
1	4W	51	2688 m <sup>3</sup> /hr

MODEL NO	COLOUR	DESCRIPTION
20067/05	White	Fan only
20067/06	Black	
20067/62	Mahogany/Black	
20067/65	Maple/Black	

# HERCULES 82

DC CEILING FAN – 82 INCH

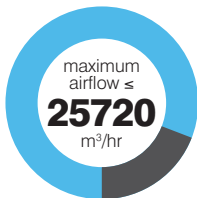

**45W** DC MOTOR    **12°** BLADE PITCH    **82IN** 2080mm    **6YR** WARRANTY

- High volume airflow for large areas with a smooth and quiet operation
- Steel body and canopy construction
- 6 x durable ABS blades
- Ceiling rake 17 degree maximum
- 5 speed remote control with reverse function and light on/off
- Optional light kit – 18W 1000lm 4200K LED dimmable
- For indoors or enclosed alfresco areas not exposed to the weather

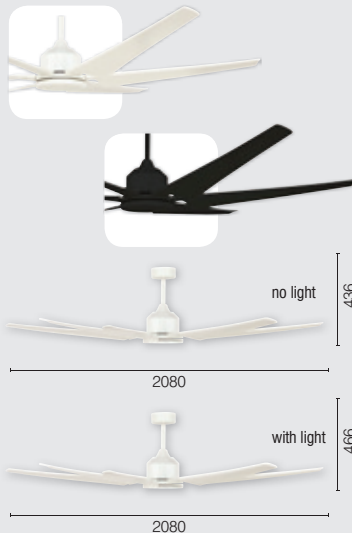

### FAN LIGHT KIT (sold separately)

- 20099/05 white



### EXTENSION RODS WITH LOOM KITS (sold separately)

- 900mm x Ø26mm  
18627/55 matt white, 18627/06 matt black

SPEED	POWER	RPM	AIRFLOW
5	46W	95	25,720 m <sup>3</sup> /hr
4	30W	83	22,471 m <sup>3</sup> /hr
3	14W	75	20,305 m <sup>3</sup> /hr
2	11W	57	15,432 m <sup>3</sup> /hr
1	8W	44	11,912 m <sup>3</sup> /hr

MODEL NO	COLOUR	DESCRIPTION
20491/05	Matt White	Fan only
20491/06	Matt Black	



# HERCULES 84

DC CEILING FAN – 84 INCH

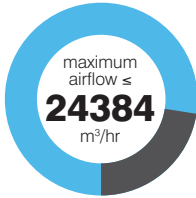

**35W**  
DC MOTOR

**10°**  
BLADE  
PITCH

**84IN**  
2140mm

**6YR**  
WARRANTY

- High volume airflow for large areas with a smooth and quiet operation
- Steel body and canopy construction
- 6 x extruded aluminium (anodised) blades
- Ceiling rake 17 degree maximum
- 6 speed remote control with reverse function and light on/off
- Optional light kit – 18W 1000lm 4200K LED dimmable
- For indoors or enclosed alfresco areas not exposed to the weather



### FAN LIGHT KIT (sold separately)

- 20099/05 white, 20099/13 satin nickel



### EXTENSION RODS WITH LOOM KITS (sold separately)

- 900mm x Ø26mm  
18627/05 white, 18628/13 satin nickel
- 1800mm x Ø26mm – 18769/05 white



SPEED	POWER	RPM	AIRFLOW
6	35W	87	24,384 m <sup>3</sup> /hr
5	23W	75	19,813 m <sup>3</sup> /hr
4	14W	63	17,579 m <sup>3</sup> /hr
3	9W	52	14,270 m <sup>3</sup> /hr
2	6W	42	11,712 m <sup>3</sup> /hr
1	4W	30	8765 m <sup>3</sup> /hr

MODEL NO	COLOUR	DESCRIPTION
20073/05	White	Fan only
20073/13	Satin Nickel	Fan only

# HERCULES 96

DC CEILING FAN – 96 INCH



**45W**  
DC MOTOR

**10°**  
BLADE  
PITCH

**96IN**  
2440mm

**6YR**  
WARRANTY

- High volume airflow for large areas with a smooth and quiet operation
- Steel body and canopy construction
- 6 x extruded aluminium (anodised) blades
- Ceiling rake 17 degree maximum
- 5 speed remote control with reverse function and timer
- Optional light kit – 18W 1000lm 4200K LED dimmable
- For indoors or enclosed alfresco areas not exposed to the weather

### FAN LIGHT KIT (sold separately)

- 20099/05 white, 20099/13 satin nickel



### EXTENSION RODS WITH LOOM KITS (sold separately)

- 900mm x Ø26mm  
18627/05 white, 18628/13 satin nickel
- 1800mm x Ø26mm – 18769/05 white

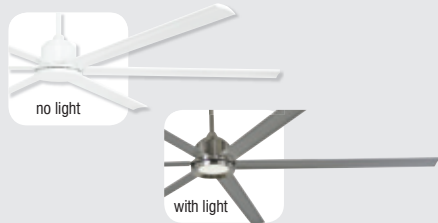

MODEL NO	COLOUR	DESCRIPTION
20079/05	White	Fan only
20079/13	Satin Nickel	Fan only

SPEED	POWER	RPM	AIRFLOW
5	46W	81	28,834 m <sup>3</sup> /hr
4	29W	71	25,273 m <sup>3</sup> /hr
3	15W	60	20,889 m <sup>3</sup> /hr
2	10W	51	17,755 m <sup>3</sup> /hr
1	6W	41	12,979 m <sup>3</sup> /hr

# HERCULES MAX 120

INDUSTRIAL SIZED DC CEILING FAN – 120 INCH



maximum  
airflow ≤  
**31500**  
m<sup>3</sup>/hr



Remote  
Included

**65W**  
DC MOTOR

**8°**  
BLADE  
PITCH

**120IN**  
3050mm

**6YR**  
WARRANTY

- High volume airflow for large areas with a smooth and quiet operation
- Steel body and canopy construction
- 6 x extruded aluminium (anodised) blades
- Ceiling rake 30 degree maximum
- 5 speed remote control with reverse function and light on/off
- Optional light kit – 18W 1000lm 4200K LED dimmable
- For indoors or enclosed alfresco areas not exposed to the weather



#### FAN LIGHT KIT (sold separately)

- 20099/06 black, 20099/13 satin nickel



#### EXTENSION RODS WITH LOOM KITS (sold separately)

- 900mm x Ø26mm, 21021/13 satin nickel, 21021/06 matt black
- 1800mm x Ø26mm, 21466/13 satin nickel, 21466/06 matt black



3050

MODEL NO	COLOUR	DESCRIPTION
20899/06	Matt black with aluminium blades	Fan only
20899/13	Satin nickel with aluminium blades	

SPEED	POWER	RPM	AIRFLOW
5	65W	76	31,500 m <sup>3</sup> /hr
4	45W	63	26,112 m <sup>3</sup> /hr
3	24W	51	21,138 m <sup>3</sup> /hr
2	19W	40	16,579 m <sup>3</sup> /hr
1	14W	33	13,678 m <sup>3</sup> /hr



# MAVERICK

DC CEILING FAN – 60 INCH

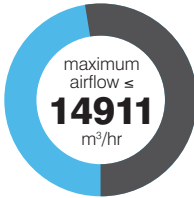

Remote Included

**37W**  
DC MOTOR

**12°**  
BLADE  
PITCH

**60IN**  
1520mm

**6YR**  
WARRANTY

- Metal body and canopy construction
- 3 x moulded durable ABS blades with decorative lines
- Ceiling rake 14 degree maximum
- 5 speed remote control with reverse function and timer
- For indoors or enclosed alfresco areas not exposed to the weather



## EXTENSION RODS WITH LOOM KITS (sold separately)

- 900mm x Ø26mm  
18240/14 oil rubbed bronze, 47801/13 satin nickel



MODEL NO	COLOUR	DESCRIPTION
20527/13	Satin nickel with distressed oak blades	Fan only
20527/14	Oil rubbed bronze with mahogany blades	

SPEED	POWER	RPM	AIRFLOW
5	37W	205	14911 m³/hr
4	21W	172	11964 m³/hr
3	14W	151	10490 m³/hr
2	9W	126	8299 m³/hr
1	5W	93	6011 m³/hr



Remote Included



**50W**  
DC MOTOR

**20°**  
BLADE  
PITCH

**66IN**  
1670mm

**6YR**  
WARRANTY

- Steel body and canopy construction
- 3 x moulded durable ABS blades
- Ceiling rake 14 degree maximum
- 5 speed remote control with reverse function and light on/off
- Optional light kit – 18W 1000lm 4200K LED dimmable
- For indoors or enclosed alfresco areas not exposed to the weather



### FAN LIGHT KIT (sold separately)

- 20099/05 white



### EXTENSION RODS WITH LOOM KITS (sold separately)

- 900mm x Ø26mm  
18627/05 matt white, 18627/14 oil-rubbed bronze
- 1800mm x Ø26mm  
18769/05 matt white



SPEED	POWER	RPM	AIRFLOW
5	50W	115	15,980 m <sup>3</sup> /hr
4	38W	96	12,560 m <sup>3</sup> /hr
3	20W	67	10,750 m <sup>3</sup> /hr
2	14W	48	8010 m <sup>3</sup> /hr
1	9W	29	5750 m <sup>3</sup> /hr

MODEL NO	COLOUR	DESCRIPTION
20894/05	Matt White	Fan only
20894/14	Oil Rubbed Bronze	Fan only

# TEMPEST DC

DC CEILING FAN – 52 INCH



maximum  
airflow ≤  
**12503**  
m<sup>3</sup>/hr



Remote  
Included

SWITCH TO ADJUST COLOUR TEMPERATURE

WARM WHITE > COOL WHITE > DAYLIGHT

**37W**  
DC MOTOR

**11°**  
BLADE  
PITCH

**52IN**  
1320mm

**6YR**  
WARRANTY

- Diecast aluminium body and canopy construction
- 4 x painted plywood blades
- Ceiling rake 14 degree maximum
- 5 speed remote control with reverse function and timer
- Light models – 24W 1600lm LED  
CCT switchable between 3000K, 4200K and 6500K
- For indoor locations around the home



no light



with light

**EXTENSION RODS WITH LOOM KITS  
(sold separately)**

- 900mm x Ø21mm  
47801/05 white



no light

1320



with light

360

SPEED	POWER	RPM	AIRFLOW
<b>5</b>	37W	243	12,503 m <sup>3</sup> /hr
<b>4</b>	21W	203	10,448 m <sup>3</sup> /hr
<b>3</b>	12W	163	7920 m <sup>3</sup> /hr
<b>2</b>	8W	132	6792 m <sup>3</sup> /hr
<b>1</b>	5W	96	4420 m <sup>3</sup> /hr

MODEL NO	COLOUR	DESCRIPTION
<b>19571/05</b>	White	Fan only
<b>19573/05</b>	White	Fan with light





# AC MOTOR CEILING FANS

AC stands for alternating current, meaning the electrical flow changes direction 50 times a second in order to provide a constant flow compared to a DC fan that has a variable, uneven flow.

AC fans are commonly used when consistent and even airflow is required. These fans are commonly used in domestic appliances.

AC fans can use a simple wall controller and are often easier to operate.

---

## WALL CONTROLLER

AC ceiling fans are normally operated via a wall controller, whereas DC ceiling fans can only be operated via a remote control.

They can also be controlled using the Standard remote control 99999, LCD model 99222 and WiFi model 99111.

---

## INSTALLATION CONDITIONS/WARRANTY

Warranty on fans is 6 years which includes 3 year in-home + additional 3 years on the motor.

The warranted use of fans outdoors are limited to Enclosed Alfresco like areas where conditions are similar to indoor installations.

The warranty conditions for fans installed in Enclosed Alfresco areas are as follows:

- Fan must be shielded from wind and rain (enclosed area, minimum 15m from edge of eave/roof).
- The warranty will cover open circuit motor faults, and remote control faults if not related to outdoor exposure.
- The Warranty will not cover outdoor related issues such as rusting, or failure clearly caused by water, moisture or wind.
- The Warranty will not cover external appearance or finish of any part of the ceiling fan.
- The Warranty will not cover wooden blades. These are recommended only to be used indoors.

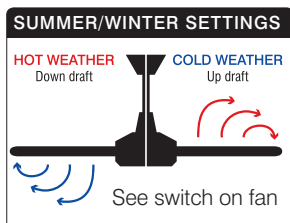

Brilliant's all-seasons technology is for use all year round.

Summer mode – blades rotate clockwise to push cool air down.

Winter mode – blades rotate anti-clockwise at a low speed.

A gentle updraft pushes warm air down along the walls to the floor.

Note: All energy saving and air movement data is produced by an accredited test lab. In-home results may vary depending on circumstances and installation.

# AIRMOTION 48

## ALUMINIUM BLADE AC CEILING FAN – 48 INCH

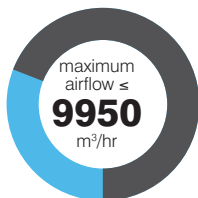
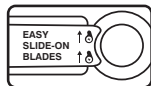

3-speed wall control included



**50W**  
AC MOTOR

**14°**  
BLADE  
PITCH

**48IN**  
1220mm

**6YR**  
WARRANTY

- Steel body and canopy construction
- 3 x aluminium blades
- J-Hook or Hangsure installation options
- Ceiling rake 30 degree maximum (Hangsure mount)
- 3 speed wall control
- Pre-wired for light kit
- For indoors or enclosed alfresco areas not exposed to the weather



### J HOOK MOUNTING

Suitable for level ceiling only



### HANGSURE MOUNTING

Suitable for level and inclined ceiling



### EXTENSION RODS WITH LOOM KITS (sold separately)

- 900mm x Ø21mm  
100550/05 white



MODEL NO	COLOUR	DESCRIPTION
20891/05	J-hook mount – white	Fan only
20892/05	Hangsure mount – white	Fan only

SPEED	POWER	RPM	AIRFLOW
3	50W	242	9950 m <sup>3</sup> /hr
2	28W	131	6040 m <sup>3</sup> /hr
1	15W	81	3670 m <sup>3</sup> /hr

# AIRMOTION 56

ALUMINIUM BLADE AC CEILING FAN – 56 INCH

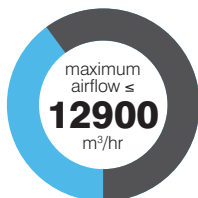
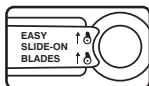

**70W**  
AC MOTOR

**10°**  
BLADE  
PITCH

**56IN**  
1420mm

**6YR**  
WARRANTY

3-speed wall control included



- Steel body and canopy construction
- 3 x aluminium blades
- Hangsure installation
- Ceiling rake 30 degree maximum
- 3 speed wall control
- Pre-wired for light kit
- For indoors or enclosed alfresco areas not exposed to the weather



**HANGSURE MOUNTING**  
Suitable for level and inclined ceiling



## EXTENSION RODS WITH LOOM KITS (sold separately)

- 900mm x Ø21mm  
100550/05 white



MODEL NO	COLOUR	DESCRIPTION
20893/05	Hangsure mount – white	Fan only

SPEED	POWER	RPM	AIRFLOW
3	70W	281	12,900 m <sup>3</sup> /hr
2	30W	173	6440 m <sup>3</sup> /hr
1	14W	96	3280 m <sup>3</sup> /hr

# ATRIUM

## AC CEILING FAN – 48 & 52 INCH

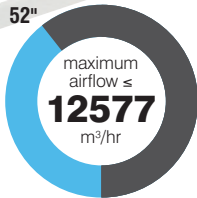
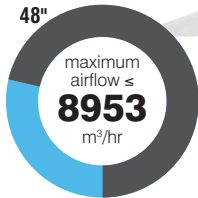

**70W** AC MOTOR    **5°** BLADE PITCH    **48IN** 1220mm    **52IN** 1320mm    **6YR** WARRANTY



- Stainless steel (316) body and canopy construction
- 4 x stainless steel (316) blades
- Ceiling rake 32 degree maximum
- 3 speed wall control
- Optional light kit – 1 x 40W max E27 (glass diffuser)
- For indoor or in undercover outdoor areas – suitable for coastal areas

### FAN LIGHT KIT (sold separately)

- 20108/16 stainless steel (316)

### EXTENSION RODS WITH LOOM KITS (sold separately)

- 900mm x Ø21mm 100666/16 stainless steel

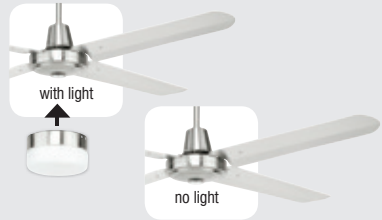

MODEL NO	COLOUR
20101/16	Stainless steel (316) 48"

SPEED	POWER	RPM	AIRFLOW
3	65W	301	8,953m <sup>3</sup> /hr
2	28W	175	6,077 m <sup>3</sup> /hr
1	14W	104	3,268 m <sup>3</sup> /hr

MODEL NO	COLOUR
20102/16	Stainless steel (316) 52"

SPEED	POWER	RPM	AIRFLOW
3	68W	265	12,477m <sup>3</sup> /hr
2	29W	148	6,538 m <sup>3</sup> /hr
1	14W	87	3,310 m <sup>3</sup> /hr

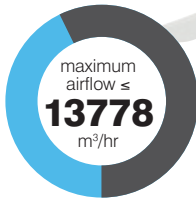

**80W**  
AC MOTOR

**5°**  
BLADE  
PITCH

**56IN**  
1420mm

**6YR**  
WARRANTY

3-speed wall  
control included



- Stainless steel (316) body and canopy construction
- 4 x stainless steel (316) blades
- Ceiling rake 32 degree maximum
- 3 speed wall control
- Optional light kit – 1 x 40W max E27 (glass diffuser)
- For indoor or in undercover outdoor areas – suitable for coastal areas



### FAN LIGHT KIT (sold separately)

- 20108/16 stainless steel (316)

### EXTENSION RODS WITH LOOM KITS (sold separately)

- 900mm x Ø21mm (loom included), 100666/16 stainless steel



MODEL NO	COLOUR
20103/16	Stainless steel (316) 56"

SPEED	POWER	RPM	AIRFLOW
3	74W	242	13,778m <sup>3</sup> /hr
2	29W	131	6,922 m <sup>3</sup> /hr
1	13W	82	3,863 m <sup>3</sup> /hr

# AUSTIN

## AC CEILING FAN – 48 INCH

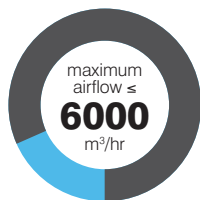

**50W**  
AC MOTOR

**10°**  
BLADE  
PITCH

**48IN**  
1220mm

**6YR**  
WARRANTY

- Metal body and canopy construction
- 4 x painted MDF blades
- Ceiling rake 25 degree maximum
- 3 speed wall control
- For indoor locations around the home

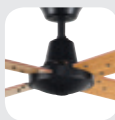

### EXTENSION RODS WITH LOOM KITS (sold separately)

- 900mm x Ø21mm  
100550/06 matt black, 20287/11 dark metallic

*Note: For these fans, the wiring loom must be hard-wired by an electrician*



MODEL NO	COLOUR
<b>19645/06</b>	Black/Maple
<b>19645/11</b>	Metallic Silver/Oak

SPEED	POWER	RPM	AIRFLOW
<b>3</b>	50W	210	6000 m <sup>3</sup> /hr
<b>2</b>	23W	175	4400 m <sup>3</sup> /hr
<b>1</b>	11W	125	2290 m <sup>3</sup> /hr



# CRUZE

## AC CEILING FAN – 52 INCH

### EZI-FIT BLADES

QUICK & EASY INSTALLATION

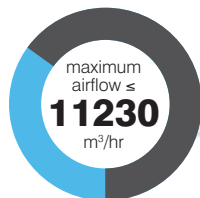

SWITCH TO ADJUST COLOUR TEMPERATURE

WARM WHITE > COOL WHITE > DAYLIGHT

**50W**  
AC MOTOR

**11°**  
BLADE  
PITCH

**52IN**  
1320mm

**6YR**  
WARRANTY

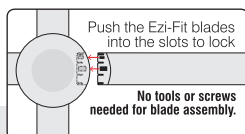

- ABS body and canopy construction
- 4 x durable ABS blades
- Ceiling rake 32 degree maximum
- 3 speed wall control
- Light models – 18W 1200lm LED dimmable CCT switchable between 3000K, 4200K and 6000K (change from wall switch)
- UV and corrosion resistant
- For indoors or enclosed alfresco areas not exposed to the weather

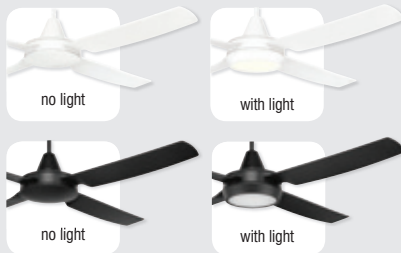

### EXTENSION RODS WITH LOOM KITS (sold separately)

- 900mm x Ø21mm  
20252/05 matt white, 20252/06 matt black, 100550/06 matt black



MODEL NO	COLOUR	DESCRIPTION
20530/05	Matt White	Fan only
20532/05	Matt White	Fan with light
20530/06	Matt Black	Fan only
20532/06	Matt Black	Fan with light

SPEED	POWER	RPM	AIRFLOW
3	50W	215	11230m <sup>3</sup> /hr
2	27W	157	8290m <sup>3</sup> /hr
1	15W	113	5724m <sup>3</sup> /hr



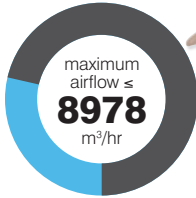

3-speed wall  
control included



**50W**  
AC MOTOR

**12°**  
BLADE  
PITCH

**52IN**  
1320mm

**6YR**  
WARRANTY

- Metal body and canopy construction
- 3 x handcrafted solid timber blades
- Ceiling rake 32 degree maximum
- 3 speed wall control
- For indoor locations around the home



### EXTENSION RODS WITH LOOM KITS (sold separately)

- 900mm x Ø21mm  
100550/13 satin nickel, 18240/14 oil-rubbed bronze\*



\* Corrosion resistant does not apply to the metal downrod

MODEL NO	COLOUR	DESCRIPTION
20533/13	Satin Nickel/Natural	Fan only
20533/14	Oil-rubbed Bronze/Rich timber	

SPEED	POWER	RPM	AIRFLOW
3	50W	190	8978 m <sup>3</sup> /hr
2	17W	111	5209 m <sup>3</sup> /hr
1	9W	79	3055 m <sup>3</sup> /hr

# TEMPEST

## AC CEILING FAN – 52 INCH



- Diecast aluminium body and canopy construction
- 4 x painted plywood blades
- Ceiling rake 32 degree maximum
- 3 speed wall control
- Light models – 2 x 40W max B22 (glass diffuser)
- For indoor locations around the home



### EXTENSION RODS WITH LOOM KITS (sold separately)

- 900mm x Ø21mm  
100550/05 white, 100550/06 matt black,  
10550/20 brushed aluminium

MODEL NO	COLOUR	DESCRIPTION
99983/05	White	Fan only
99983/06	Matt Black	
99983/13	Brushed Aluminium	
99988/05	White	Fan with B22 light
99988/06	Matt Black	
99988/13	Brushed Aluminium	

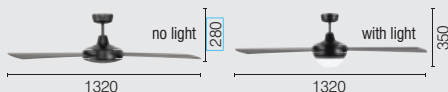

SPEED	POWER	RPM	AIRFLOW
<b>3</b>	54W	188	10,450 m <sup>3</sup> /hr
<b>2</b>	22W	116	6,500 m <sup>3</sup> /hr
<b>1</b>	12W	73	4,250 m <sup>3</sup> /hr

# TEMPEST LED

AC CEILING FAN – 52 INCH



SWITCH TO ADJUST COLOUR TEMPERATURE

WARM WHITE > COOL WHITE > DAYLIGHT

**50W**  
AC MOTOR

**11°**  
BLADE  
PITCH

**52IN**  
1320mm

**6YR**  
WARRANTY

3-speed wall control included



- Diecast aluminium body and canopy construction
- 4 x painted plywood blades
- Ceiling rake 32 degree maximum
- 3 speed wall control
- Light models 18W 1600lm LED dimmable CCT switchable between 3000K, 4200K and 6000K
- For indoor locations around the home



### EXTENSION RODS WITH LOOM KITS (sold separately)

- 900mm x Ø21mm  
100550/05 white, 100550/06 matt black, 100550/20 brushed aluminium

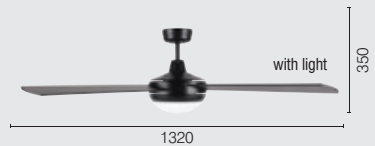

MODEL NO	COLOUR	DESCRIPTION
20580/05	White	Fan with CCT LED light
20580/06	Matt Black	
20580/13	Brushed Aluminium	

SPEED	POWER	RPM	AIRFLOW
3	54W	188	10,450 m³/hr
2	22W	116	6,500 m³/hr
1	12W	73	4,250 m³/hr

# TEMPEST SUPREME

AC CEILING FAN – 52 INCH

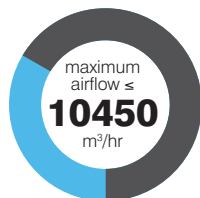

SWITCH TO ADJUST COLOUR TEMPERATURE

WARM WHITE > COOL WHITE > DAYLIGHT

**50W**  
AC MOTOR

**11°**  
BLADE  
PITCH

**52IN**  
1320mm

**6YR**  
WARRANTY

3-speed wall control included



- Diecast aluminium body and canopy construction
- 4 x painted plywood blades
- Ceiling rake 32 degree maximum
- Fan drop 325mm
- 3 speed wall control
- Light – 18W 1200lm LED dimmable  
CCT switchable between 3000K, 4200K and 6000K  
(change from wall switch)
- For indoor locations around the home



## EXTENSION RODS WITH LOOM KITS (sold separately)

- 900mm x Ø21mm  
100550/05 white, 100550/06 matt black



MODEL NO	COLOUR	DESCRIPTION
20907/05	Matt White	Fan with CCT LED light
20907/06	Matt Black	

SPEED	POWER	RPM	AIRFLOW
3	54W	188	10,450 m <sup>3</sup> /hr
2	21W	116	6500 m <sup>3</sup> /hr
1	12W	73	4250 m <sup>3</sup> /hr

# TEMPO 48

AC CEILING FAN – 48 INCH



3-speed wall  
control included



<b>65W</b> AC MOTOR	<b>11°</b> BLADE PITCH	<b>48IN</b> 1220mm	<b>6YR</b> WARRANTY
------------------------	------------------------------	-----------------------	------------------------

- Steel body and canopy construction
- 4 x painted plywood blades
- Ceiling rake 32 degree maximum
- 3 speed wall control
- Light models – 2 x 40W max E27 globes (not included)
- For indoor locations around the home

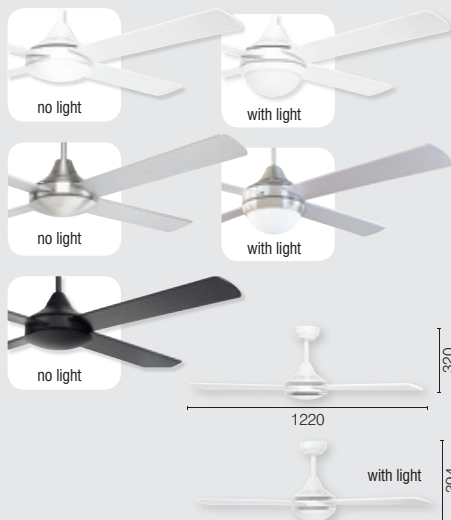

### EXTENSION RODS WITH LOOM KITS (sold separately)

- 900mm x Ø21mm  
100550/05 white, 100550/06 matt black,  
100550/13 brushed chrome

MODEL NO	COLOUR	DESCRIPTION
100010/05	White	Fan only
100010/13	Brushed chrome	
100010/06	Matt Black	
100012/05	White	Fan with light
100012/13	Brushed chrome	

SPEED	POWER	RPM	AIRFLOW
3	65W	202	7699 m <sup>3</sup> /hr
2	37W	149	5334 m <sup>3</sup> /hr
1	19W	100	3349 m <sup>3</sup> /hr

# TEMPO 52

AC CEILING FAN – 52 INCH

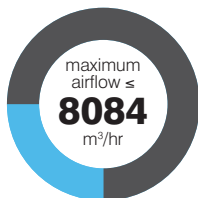

3-speed wall control included



**65W**  
AC MOTOR

**11°**  
BLADE  
PITCH

**52IN**  
1320mm

**6YR**  
WARRANTY

- Steel body and canopy construction
- 4 x painted plywood blades
- Ceiling rake 30 degree maximum
- Fan drop 320mm and 394mm with light
- 3 speed wall control
- Light models – 2 x 40W max E27 globes (not included)
- For indoor locations around the home



## EXTENSION RODS WITH LOOM KITS (sold separately)

- 900mm x Ø21mm  
100550/05 white, 100550/06 matt black,  
100550/13 brushed chrome

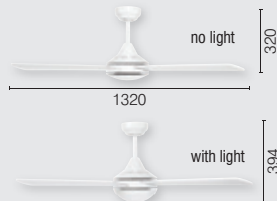

MODEL NO	COLOUR	DESCRIPTION
20910/05	White	Fan only
20910/06	Matt black	
20910/13	Brushed chrome	
20915/05	White	Fan with CCT LED light
20915/06	Matt black	
20915/13	Brushed chrome	

SPEED	POWER	RPM	AIRFLOW
<b>3</b>	65W	196	8084 m <sup>3</sup> /hr
<b>2</b>	37W	144	5601 m <sup>3</sup> /hr
<b>1</b>	19W	96	3516 m <sup>3</sup> /hr

# TEMPO REMOTE

## AC CEILING FAN WITH LIGHT AND REMOTE

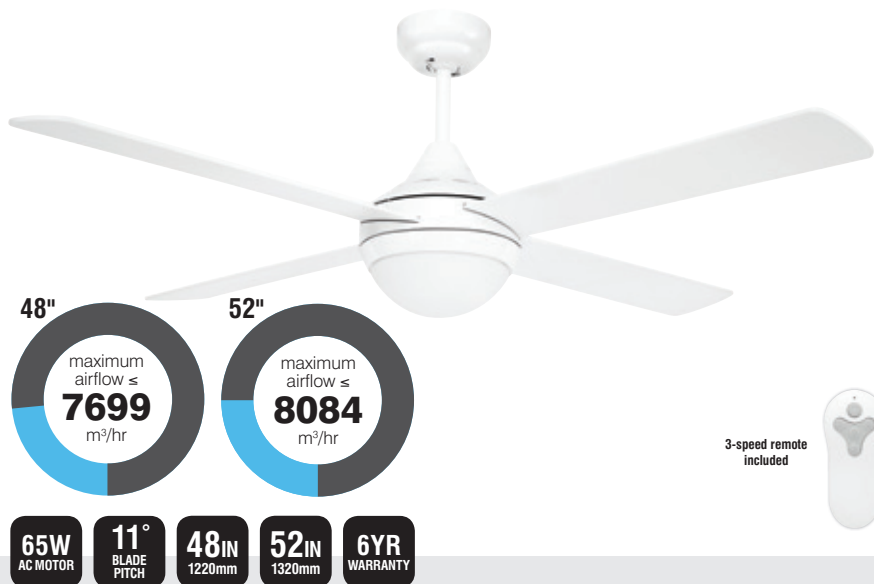

- Steel body and canopy construction
- 4 x painted plywood blades
- Ceiling rake 14 degree maximum
- 3 speed remote control with light function
- Light – 2 x 40W max E27 globes (not included)
- For indoor locations around the home

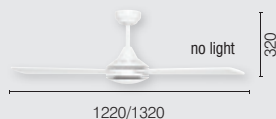

### EXTENSION RODS WITH LOOM KITS (sold separately)

- 900mm x  $\varnothing$ 21mm
- 100550/05 white

MODEL NO	COLOUR
100012/05R	White 48"

SPEED	POWER	RPM	AIRFLOW
3	65W	196	7699 m <sup>3</sup> /hr
2	37W	144	5334 m <sup>3</sup> /hr
1	19W	96	3349 m <sup>3</sup> /hr

MODEL NO	COLOUR
20915/05R	White 52"

SPEED	POWER	RPM	AIRFLOW
3	65W	196	8084 m <sup>3</sup> /hr
2	37W	144	5601 m <sup>3</sup> /hr
1	19W	96	3516 m <sup>3</sup> /hr

# VECTOR 48

AC CEILING FAN – 48 INCH

## EZI-FIT BLADES

QUICK & EASY INSTALLATION

maximum  
airflow ≤  
**9939**  
m<sup>3</sup>/hr

**50W**  
AC MOTOR

**14°**  
BLADE  
PITCH

**48IN**  
1220mm

**6YR**  
WARRANTY

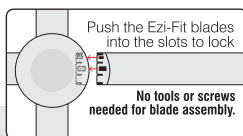

3-speed wall control included

- ABS body and canopy construction
- 4 x durable ABS blades
- Ceiling rake 15 degree maximum
- 3 speed wall control
- Light model – 20W 1000 lumen 4000K LED non-dimmable
- UV and corrosion resistant\*
- For indoors or enclosed alfresco areas not exposed to the weather



no light



with light

### EXTENSION RODS WITH LOOM KITS (sold separately)

- 900mm x Ø21mm  
20252/05 matt white

\* Corrosion resistant does not apply to the metal downrod

MODEL NO	COLOUR	DESCRIPTION
20284/05	Matt White	Fan only
20285/05	Matt White	Fan with light

SPEED	POWER	RPM	AIRFLOW
3	50W	224	9939 m <sup>3</sup> /hr
2	26W	161	6776 m <sup>3</sup> /hr
1	14W	114	4645 m <sup>3</sup> /hr



1220

no light

350



1220

with light

376

See Ezi-Fit blades  
demonstration video





# VECTOR 52

AC CEILING FAN – 52 INCH

## EZI-FIT BLADES

QUICK & EASY INSTALLATION

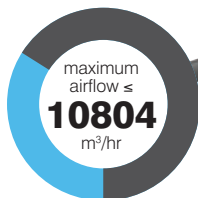

**50W**  
AC MOTOR

**14°**  
BLADE  
PITCH

**52IN**  
1320mm

**6YR**  
WARRANTY

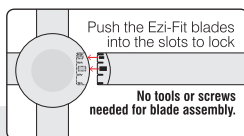

3-speed wall control included

- ABS body and canopy construction
- 4 x durable ABS blades
- Ceiling rake 15 degree maximum
- 3 speed wall control
- Light models – 20W 1000 lumen 4000K LED non-dimmable
- UV and corrosion resistant\*
- For indoors or enclosed alfresco areas not exposed to the weather



### EXTENSION RODS WITH LOOM KIT (sold separately)

- 900mm x Ø21mm  
20252/05 matt white, 20252/06 matt black,  
100550/06 matt black



\* Corrosion resistant does not apply to the metal downrod

MODEL NO	COLOUR	DESCRIPTION
20167/05	Matt White	Fan only
20167/06	Matt Black	Fan only
20168/05	Matt White	Fan with light
20168/06	Matt Black	Fan with light

SPEED	POWER	RPM	AIRFLOW
3	50W	214	10804 m <sup>3</sup> /hr
2	26W	155	7365 m <sup>3</sup> /hr
1	15W	111	5049 m <sup>3</sup> /hr

# SMART FAN CONTROLLER

## WIFI CONTROLLER TO SUIT AC CEILING FAN



2.4 GHz

**70W**  
MAX FAN

**100W**  
MAX LIGHT

**1YR**  
WARRANTY

**99111**  
Wall control with quick connect receiver



Smart phone and fan not included

- Turn your existing AC ceiling fan into a smart fan with our universal smart ceiling fan remote control kit.
- Uses Brilliant's unique quick connect plug-in design. Quick connect allows our remotes to be installed seamlessly in minutes with any Brilliant AC fan without any wire trimming or joining.
- Compatible with most other brands of AC ceiling fans (hard-wiring may be required).
- Create schedules & timing to automate your home.
- Control from anywhere via app or voice control.
- Smart Mode: Nature, Normal, Sleep & Wake up (From App)
- Works with other BrilliantSmart products.
- Includes 3-speed with light function wireless operated wall control with batteries (2xAAA).
- Must be installed by a licensed electrician

Security: Mac Encryption; WEP/WAPI/TKIP/AES  
WiFi Standard: IEEE802.11b/g/n  
System Req's: iOS 8.0 or higher, Android 4.1 or higher

CONTROL	WALL CONTROL	APP
DISPLAY	N/A	On Device
INPUT	Soft Touch Buttons	On Screen
FAN	ON/OFF	ON/OFF
SPEED	1/2/3	1/2/3
LIGHT	ON/OFF/DIM	ON/OFF/DIM
OTHER	Wireless battery operated	Smart functions available includes Smart mode, scheduling, timers, automation, voice control along with many others in the BrilliantSmart App.



Voice control

WORKS WITH alexa

NO HUB REQUIRED

works with the Google Assistant

Works with IFTTT

# FAN REMOTES

UNIVERSAL TO SUIT AC CEILING FAN

**99999**  
Basic



**99222**  
LCD



Ceiling fan is not included. Photo used for illustration purposes only.



- Universal radio frequency ceiling fan remote controls with Brilliant's unique quick connect plug-in design.
- Quick connect allows our remotes to be installed seamlessly in minutes with any Brilliant fan without any wire trimming or joining.
- Compatible with most other brands of AC ceiling fans (hard-wiring may be required).
- Includes wall bracket and batteries (AAA).
- 1 year warranty.
- Must be installed by a licensed electrician.

FEATURE	BASIC	LCD
DISPLAY	N/A	LCD
INPUT	Soft Touch Buttons	Soft Touch Buttons
FAN	ON/OFF	ON/OFF
SPEED	LOW/MED/HIGH	LOW/MED/HIGH
LIGHT	ON/OFF	ON/OFF/DIM
DIMMER	N/A	100% – 20%
TIMER	N/A	1 – 9 Hours

## QUICK CONNECT RECEIVER

The Easy Connect connector plugs for quick and simple installation are only compatible with Brilliant Lighting fans.







# BATHROOM

Stylish and effective lighting,  
heating and exhaust fans



# BATHROOM HEATERS



# HORIZON

## 3-IN-1 BATHROOM MATE WITH CCT LED LIGHT

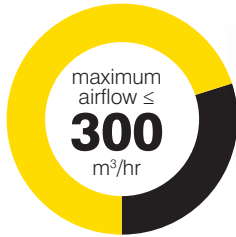

### TUNEABLE CCT

3000K — 6000K

NOW WITH CCT



- **Light:** 9W 1050 lumen centre light.
- **Heat:** 2 x E27 275W infra-red instant heat globes.
- **Exhaust:** Powerful ball bearing motor with side ducting and draft stopper.
- Low profile fascia design.
- Powerful 75W ball bearing motor.
- 125mm diameter side duct outlet with draft stopper.
- This unit is fitted with a thermostat switch that will automatically turn on the fan if the internal temperature exceeds 80°C.
- Includes wall switch, 1.5m flexible aluminium ducting and exterior grille and clamps.



DETAILS		EXHAUST			
MODEL NO.	COLOUR	NOISE (dB)	m <sup>3</sup> /min	m <sup>3</sup> /hr	L/sec
19847/05	White	≤50	≤5.0	≤300	≤83



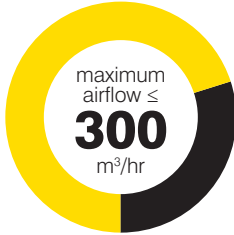

### TUNEABLE CCT

3000K — 6000K

NOW WITH CCT

**1050**  
LUMENS

**9W**  
LED

**75W**  
EXHAUST  
FAN

**275W MAX**

**IPX4**  
RATING

**300x310**

**Ø125mm**

**3YR**  
WARRANTY

- **Light:** 9W 1050 lumen centre light.
- **Heat:** 4 x E27 275W infra-red instant heat globes.
- **Exhaust:** Powerful ball bearing motor with side ducting and draft stopper.
- Low profile fascia design.
- Powerful 75W ball bearing motor.
- 125mm diameter side duct outlet with draft stopper.
- This unit is fitted with a thermostat switch that will automatically turn on the fan if the internal temperature exceeds 80°C.
- Includes wall switch, 1.5m flexible aluminium ducting and exterior grille and clamps.

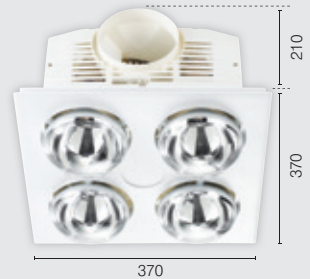

DETAILS		EXHAUST			
MODEL NO.	COLOUR	NOISE (dB)	m <sup>3</sup> /min	m <sup>3</sup> /hr	L/sec
19849/05	White	≤50	≤5.0	≤300	≤83

# NEWTON

## 3-IN-1 BATHROOM MATE WITH LED LIGHT



- **Light:** 9W 860 lumen cool white R63 LED globe.
- **Heat:** 2 x 275W instant heat globes.
- **Exhaust:** Ball bearing motor with side ducting and draft stopper.
- This unit is fitted with a thermostat switch that will automatically turn on the exhaust fan if the internal temperature exceeds 80°C.
- Includes wall switch, 1.5m length x 100mm diameter flexible aluminium ducting and exterior vent.

### ACCESSORIES (Sold separately)

- 3m Ø100mm aluminium duct 19937.
- 9W R63 800 lm warm white LED globe 20426.



DETAILS		EXHAUST			
MODEL NO.	COLOUR	NOISE (dB)	m <sup>3</sup> /min	m <sup>3</sup> /hr	L/sec
20351/05	White	$\leq 45$	$\leq 4.0$	$\leq 240$	$\leq 67$



- **Light:** 9W 860 lumen cool white R63 LED globe.
- **Heat:** 4 x 275W instant heat globes.
- **Exhaust:** Ball bearing motor with side ducting and draft stopper.
- This unit is fitted with a thermostat switch that will automatically turn on the exhaust fan if the internal temperature exceeds 80°C.
- Includes wall switch, 1.5m length x 100mm diameter flexible aluminium ducting and exterior vent.

### ACCESSORIES (Sold separately)

- 3m Ø100mm aluminium duct 19937.
- 9W R63 800 lm warm white LED globe 20426.



DETAILS		EXHAUST			
MODEL NO.	COLOUR	NOISE (dB)	m <sup>3</sup> /min	m <sup>3</sup> /hr	L/sec
20352/05	White	≤45	≤4.0	≤240	≤67

# SUPERNOVA II

3-IN-1 BATHROOM MATE WITH CCT LED PANEL LIGHT

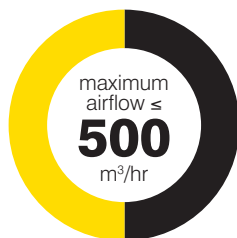

## TUNEABLE CCT

3000K — 5000K



- **Light:** 12W colour temperature adjustable LED panel, 3000K Warm White or 5000K Daylight.
- **Heat:** 2 x E27 275W infra-red heat globes (included).
- **Exhaust:** Powerful ball bearing motor with side ducting and draft stopper.
- This unit is fitted with a thermostat switch that will automatically turn on if the internal temperature exceeds 80°C.
- Includes wall switch, 1.5m x 150mm diameter flexible aluminium ducting and exterior vent.

### ACCESSORIES (Sold separately)

- 3m Ø150mm aluminium duct 19939.
- 6m Ø150mm aluminium duct 19940.



DETAILS		EXHAUST				LUMENS @ 3000K (lm)	LUMENS @ 5000K (lm)
MODEL NO.	COLOUR	NOISE (dB)	m <sup>3</sup> /min	m <sup>3</sup> /hr	L/sec		
20748/05	White	≤45	≤8.3	≤500	≤138	800	900

# SUPERNOVA II

3-IN-1 BATHROOM MATE WITH CCT LED PANEL LIGHT



## TUNEABLE CCT

3000K — 5000K

**1100**  
LUMENS

**14W**  
LED

**40W**  
EXHAUST  
FAN

**275W MAX**

**270x430**

**Ø150mm**

**3YR**  
WARRANTY

- **Light:** 14W colour temperature adjustable LED panel, 3000K Warm White or 5000K Daylight.
- **Heat:** 4 x E27 275W infra-red heat globes (included).
- **Exhaust:** Powerful ball bearing motor with side ducting and draft stopper.
- This unit is fitted with a thermostat switch that will automatically turn on if the internal temperature exceeds 80°C.
- Includes wall switch, 1.5m x 100mm diameter flexible aluminium ducting and exterior vent.

### ACCESSORIES (Sold separately)

- 3m Ø150mm aluminium duct 19939.
- 6m Ø150mm aluminium duct 19940.



DETAILS		EXHAUST				LUMENS @ 3000K (lm)	LUMENS @ 5000K (lm)
MODEL NO.	COLOUR	NOISE (dB)	m <sup>3</sup> /min	m <sup>3</sup> /hr	L/sec		
20748/05	White	$\leq 45$	$\leq 8.3$	$\leq 500$	$\leq 138$	1000	1100

# VELOCITY II

## 3-IN-1 BATHROOM MATE WITH LED LIGHT

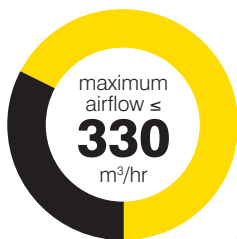

- **Light:** 9W 860 lumen cool white R63 LED globe (included).
- **Heat:** 4 x E27 275W instant heat globes (included).
- **Exhaust:** Powerful ball bearing motor with side ducting and draft stopper.
- This unit is fitted with a thermostat switch that will automatically turn on if the internal temperature exceeds 80°C.
- Includes wall switch, 1.5m x 125mm diameter flexible aluminium ducting and exterior vent.

### ACCESSORIES (Sold separately)

- 9W R63 800lm warm white LED globe 20426.



DETAILS		EXHAUST			
MODEL NO.	COLOUR	NOISE (dB)	m <sup>3</sup> /min	m <sup>3</sup> /hr	L/sec
20354/05	White	$\leq 45$	$\leq 5.5$	$\leq 330$	$\leq 91$

# VELOCITY II

## 3-IN-1 BATHROOM MATE WITH LED LIGHT

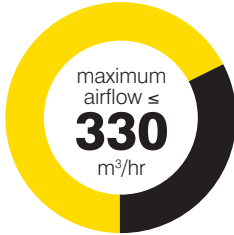

- **Light:** 9W 860 lumen cool white R63 LED globe (included).
- **Heat:** 2 x E27 275W instant heat globes (included).
- **Exhaust:** Powerful ball bearing motor with side ducting and draft stopper.
- This unit is fitted with a thermostat switch that will automatically turn on if the internal temperature exceeds 80°C.
- Includes wall switch, 1.5m x 125mm diameter flexible aluminium ducting and exterior vent.

### ACCESSORIES (Sold separately)

- 9W R63 800 lm warm white LED globe 20426.

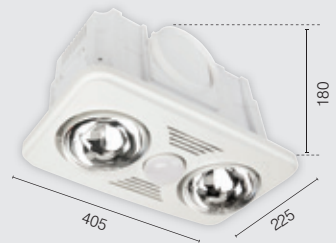

DETAILS		EXHAUST			
MODEL NO.	COLOUR	NOISE (dB)	m <sup>3</sup> /min	m <sup>3</sup> /hr	L/sec
20353/05	White	$\leq 45$	$\leq 5.5$	$\leq 330$	$\leq 91$





# EXHAUST FANS



# TORNADO

## ROUND EXHAUST FAN



- High velocity exhaust fan.
- Ball bearing motor.
- Easy installation clamps to secure fan into place.
- Removable grille for easy cleaning.
- Fitted with 0.8m plug and lead.
- Requires a switched surface socket for DIY installation.

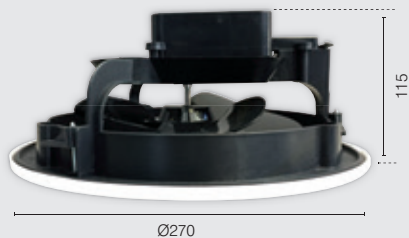

DETAILS		EXHAUST				
MODEL NO.	COLOUR	BLADE SIZE (mm)	NOISE (dB)	m <sup>3</sup> /min	m <sup>3</sup> /hr	L/sec
19911/05	White	Ø200	$\leq$ 50	$\leq$ 4.6	$\leq$ 280	$\leq$ 78

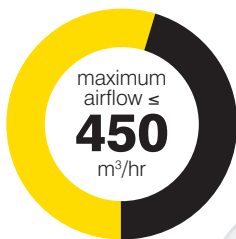

- High velocity exhaust fan.
- Ball bearing motor.
- Easy installation clamps to secure fan into place.
- Removable grille for easy cleaning.
- Fitted with 0.8m plug and lead.
- Requires a switched surface socket for DIY installation.



DETAILS		EXHAUST				
MODEL NO.	COLOUR	BLADE SIZE (mm)	NOISE (dB)	m <sup>3</sup> /min	m <sup>3</sup> /hr	L/sec
19912/05	White	Ø235	$\leq$ 50	$\leq$ 7.5	$\leq$ 450	$\leq$ 125

# WHISPER

## ROUND EXHAUST FAN

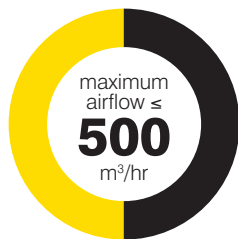

- High velocity exhaust fan.
- Ball bearing motor.
- Easy installation clamps to secure fan into place.
- Removable facia for easy cleaning.
- Draft stopper to prevent unwanted airflow coming back through the exhaust fan.
- Requires a switched surface socket for DIY installation.

### ACCESSORIES (Sold separately)

- Small duct adaptor 18207.
- 3m Ø150mm aluminium duct 19939.
- 6m Ø150mm aluminium duct 19940.

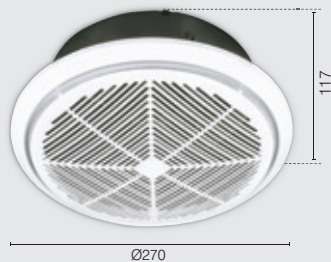

Duct Adaptor

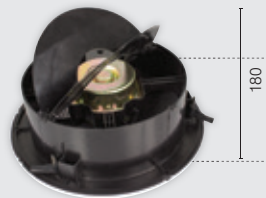

DETAILS		EXHAUST				
MODEL NO.	COLOUR	BLADE SIZE (mm)	NOISE (dB)	m <sup>3</sup> /min	m <sup>3</sup> /hr	L/sec
18203/05	White	200	$\leq 50$	$\leq 8.3$	$\leq 500$	$\leq 139$

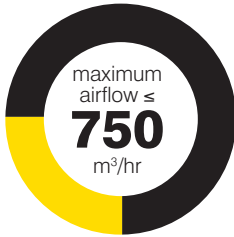

- High velocity exhaust fan.
- Ball bearing motor.
- Easy installation clamps to secure fan into place.
- Removable facia for easy cleaning.
- Draft stopper to prevent unwanted airflow coming back through the exhaust fan.
- Requires a switched surface socket for DIY installation.

### ACCESSORIES (Sold separately)

- Large duct adaptor 18208.
- 3m Ø150mm aluminium duct 19939.
- 6m Ø150mm aluminium duct 19940.

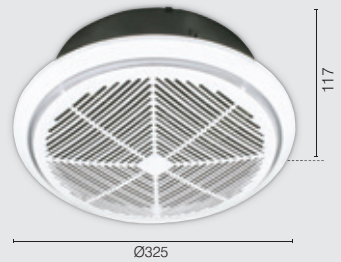

Duct Adaptor

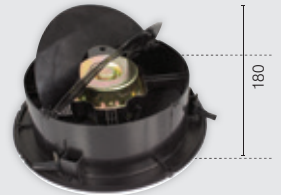

DETAILS		EXHAUST				
MODEL NO.	COLOUR	BLADE SIZE (mm)	NOISE (dB)	m <sup>3</sup> /min	m <sup>3</sup> /hr	L/sec
18204/05	White	255	$\leq 52$	$\leq 12.5$	$\leq 750$	$\leq 208$

# SARICO II

## SQUARE EXHAUST FAN

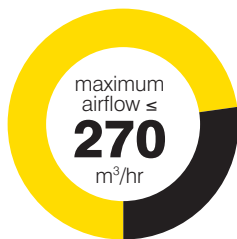

- **Exhaust:** Powerful ball bearing motor with side ducting and draft stopper.
- Easy installation clamps to secure fan in place.
- Removable fascia for easy cleaning.
- Requires a switched surface socket or DIY installation.

### ACCESSORIES (Sold separately)

- 3m Ø150mm aluminium duct 19939.
- 6m Ø150mm aluminium duct 19940.



DETAILS		EXHAUST			
MODEL NO.	COLOUR	NOISE (dB)	m <sup>3</sup> /min	m <sup>3</sup> /hr	L/sec
18193/05	White	$\leq 45$	$\leq 4.5$	$\leq 270$	$\leq 75$

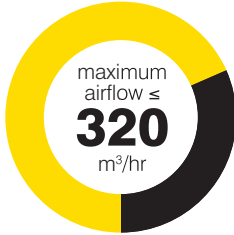

325mm



- **Exhaust:** Powerful ball bearing motor with side ducting and draft stopper.
- Easy installation clamps to secure fan in place.
- Removable facia for easy cleaning.
- Requires a switched surface socket for DIY installation.

#### ACCESSORIES (Sold separately)

- 3m Ø150mm aluminium duct 19939.
- 6m Ø150mm aluminium duct 19940.



DETAILS		EXHAUST			
MODEL NO.	COLOUR	NOISE (dB)	m <sup>3</sup> /min	m <sup>3</sup> /hr	L/sec
18194/05	White	$\leq 45$	$\leq 5.3$	$\leq 320$	$\leq 88$

# SARICO LED

## SQUARE EXHAUST FAN WITH LED LIGHT

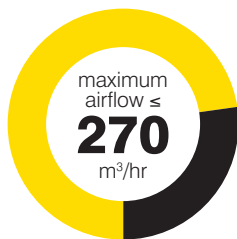

- **Light:** 9W 650 lumen LED panel.
- **Exhaust:** Powerful ball bearing motor with side ducting and draft stopper.
- Easy installation clamps.
- Removable facia for easy cleaning.
- Separate fan and light control with 0.9m flex and plugs.

### ACCESSORIES (Sold separately)

- 3m Ø150mm aluminium duct 19939.
- 6m Ø150mm aluminium duct 19940.

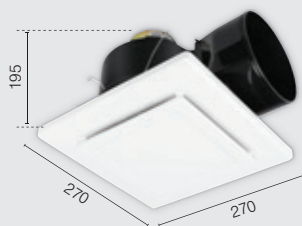

DETAILS		EXHAUST			
MODEL NO.	COLOUR	NOISE (dB)	m <sup>3</sup> /min	m <sup>3</sup> /hr	L/sec
20398/05	White	$\leq 45$	$\leq 4.5$	$\leq 270$	$\leq 75$



# SARICO LED

## SQUARE EXHAUST FAN WITH LED LIGHT

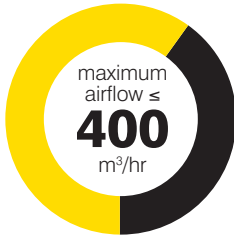

**1000**  
LUMENS

**13W**  
LED

**4200K**  
COOL  
WHITE

**45W**  
MOTOR

**IPX4**  
RATING

  
**Ø295**

  
**Ø150mm**

**DIY**  

**3YR**  
WARRANTY

- **Light:** 13W 1000 lumen LED panel.
- **Exhaust:** Powerful ball bearing motor with side ducting and draft stopper.
- Easy installation clamps.
- Removable fascia for easy cleaning.
- Separate fan and light control with 0.9m flex and plugs.

### ACCESSORIES (Sold separately)

- 3m Ø150mm aluminium duct 19939.
- 6m Ø150mm aluminium duct 19940.



DETAILS		EXHAUST			
MODEL NO.	COLOUR	NOISE (dB)	m <sup>3</sup> /min	m <sup>3</sup> /hr	L/sec
20399/05	White	$\leq 45$	$\leq 6.3$	$\leq 400$	$\leq 111$

# TALON

## ROUND EXHAUST FAN



- **Exhaust:** Powerful ball bearing motor with side ducting and draft stopper.
- Easy installation clamps.
- 150mm side exhaust duct.
- Removable facia for easy cleaning.
- Requires a switched surface socket for DIY installation.

### ACCESSORIES (Sold separately)

- 3m Ø150mm aluminium duct 19939.
- 6m Ø150mm aluminium duct 19940.

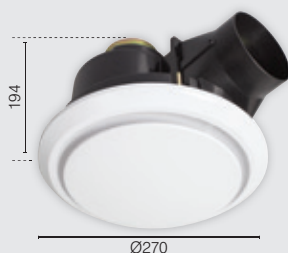

DETAILS		EXHAUST			
MODEL NO.	COLOUR	NOISE (dB)	m <sup>3</sup> /min	m <sup>3</sup> /hr	L/sec
18255/05	White	$\leq 45$	$\leq 4.5$	$\leq 270$	$\leq 75$
18255/16	Stainless Steel	$\leq 45$	$\leq 4.5$	$\leq 270$	$\leq 75$

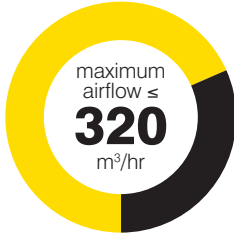

- **Exhaust:** Powerful ball bearing motor with side ducting and draft stopper.
- Easy installation clamps.
- 150mm side exhaust duct.
- Removable facia for easy cleaning.
- Requires a switched surface socket for DIY installation.

#### ACCESSORIES (Sold separately)

- 3m Ø150mm aluminium duct 19939.
- 6m Ø150mm aluminium duct 19940.



DETAILS		EXHAUST			
MODEL NO.	COLOUR	NOISE (dB)	m <sup>3</sup> /min	m <sup>3</sup> /hr	L/sec
18190/05	White	$\leq 45$	$\leq 5.3$	$\leq 320$	$\leq 88$
18190/16	Stainless Steel	$\leq 45$	$\leq 5.3$	$\leq 320$	$\leq 88$

# TALON LED

## ROUND EXHAUST FAN WITH LED LIGHT



- **Light:** 9W 650 lumen LED panel.
- **Exhaust:** Powerful ball bearing motor with side ducting and draft stopper.
- Easy installation clamps.
- Removable fascia for easy cleaning.
- Separate fan and light control with 0.9m flex and plugs.

### ACCESSORIES (Sold separately)

- 3m Ø150mm aluminium duct 19939.
- 6m Ø150mm aluminium duct 19940.



DETAILS		EXHAUST			
MODEL NO.	COLOUR	NOISE (dB)	m <sup>3</sup> /min	m <sup>3</sup> /hr	L/sec
20396/05	White	$\leq 45$	$\leq 4.5$	$\leq 270$	$\leq 75$

# TALON LED

## ROUND EXHAUST FAN WITH LED LIGHT

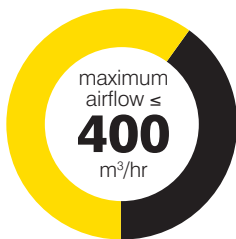

- **Light:** 13W 1000 lumen LED panel.
- **Exhaust:** Powerful ball bearing motor with side ducting and draft stopper.
- Easy installation clamps.
- Removable fascia for easy cleaning.
- Separate fan and light control with 0.9m flex and plugs.

### ACCESSORIES (Sold separately)

- 3m Ø150mm aluminium duct 19939.
- 6m Ø150mm aluminium duct 19940.



DETAILS		EXHAUST			
MODEL NO.	COLOUR	NOISE (dB)	m <sup>3</sup> /min	m <sup>3</sup> /hr	L/sec
20397/05	White	$\leq 45$	$\leq 6.3$	$\leq 400$	$\leq 111$

# BOREAL II

## EXHAUST FAN WITH CCT LED LIGHT

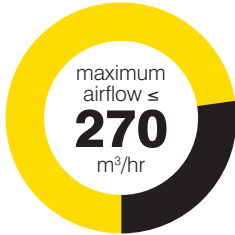

### TUNEABLE CCT

3000K — 6000K



- **Light:** 12W Colour Temperature Switchable downlight.
- **Exhaust:** Powerful ball bearing motor with side ducting and draft stopper.
- CCT switchable between Warm White (3000K), Cool White (4200K) & Daylight (6000K). Toggle wall switch to change colour temperatures.
- Easy installation clamps.
- Removable fascia for easy cleaning.
- Requires a switched surface socket for DIY installation.

### ACCESSORIES (Sold separately)

- 3m Ø150mm aluminium duct 19939.
- 6m Ø150mm aluminium duct 19940.

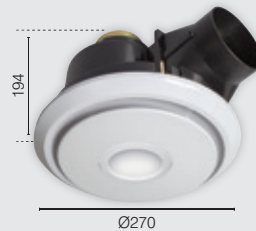

DETAILS		EXHAUST					LUMENS @ 3000K (lm)	LUMENS @ 4200K (lm)	LUMENS @ 6000K (lm)
MODEL NO.	COLOUR	FAN SIZE (mm)	NOISE (dB)	m <sup>3</sup> /min	m <sup>3</sup> /hr	L/sec			
20750/05	White	124	≤45	≤4.5	≤270	≤75	850	1000	850

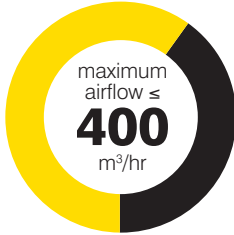

Ø325mm



### TUNEABLE CCT

3000K — 6000K



- **Light:** 12W Colour Temperature Switchable downlight.
- **Exhaust:** Powerful ball bearing motor with side ducting and draft stopper.
- CCT switchable between Warm White (3000K), Cool White (4200K) & Daylight (6000K). Toggle wall switch to change colour temperatures.
- Easy installation clamps.
- Removable facia for easy cleaning.
- Requires a switched surface socket for DIY installation.

#### ACCESSORIES (Sold separately)

- 3m Ø150mm aluminium duct 19939.
- 6m Ø150mm aluminium duct 19940.



DETAILS		EXHAUST					LUMENS @ 3000K (lm)	LUMENS @ 4200K (lm)	LUMENS @ 6000K (lm)
MODEL NO.	COLOUR	FAN SIZE (mm)	NOISE (dB)	m <sup>3</sup> /min	m <sup>3</sup> /hr	L/sec			
20751/05	White	144	≤45	≤5.3	≤320	≤88	850	1000	850

# HELIOS

## ROUND EXHAUST FAN WITH LED LIGHT



- **Light:** 8W 850 lumen LED downlight.
- **Exhaust:** Powerful ball bearing motor with side ducting and draft stopper.
- DIY installation with 2 x 0.9m cords (separate cords for fan and light).
- Removable fascia for easy cleaning.
- 150mm diameter duct outlet.

### ACCESSORIES (Sold separately)

- 3m Ø150mm aluminium duct 19939.
- 6m Ø150mm aluminium duct 19940.



DETAILS		EXHAUST				
MODEL NO.	COLOUR	IMPELLER (mm)	NOISE (dB)	m <sup>3</sup> /min	m <sup>3</sup> /hr	L/sec
19851/05	White	Ø170	$\leq 45$	$\leq 5.3$	$\leq 320$	$\leq 89$





# AIR TRANSFER KITS

Air transfer kits move excess hot or cold air from one room to another, so you heat or cool your house more efficiently.

## Circulate Trapped Air

Home insulation and heating products (fires, gas, electric heating, etc) have all improved in quality and efficiency over the years and in many instances home owners are finding their heating systems are over-efficient for the room they are situated in. An air transfer kit will exhaust excess hot/cold air that would otherwise be wasted and circulate it to a designated room. The benefits of an air transfer system include saving energy and removing the need to buy additional heater elements for the other rooms. The key principle is to transfer air not to waste it.

## Transfer the Air to Another Room

This problem is easily and inexpensively overcome with the installation of an air transfer system, which utilises this otherwise wasted air by moving it throughout the home.

## How our Air Transfer Kit works

Warm/Cool air is picked up through a ceiling vent which is ideally placed opposite the heating/cooling element to allow the source room to heat/cool first. An inline fan will then transfer the hot/cold air to the vents in the destination room(s). The system can be controlled manually via a wall switch or through a thermostat (not included), (controlled by the temperature of the room).

## Why Use An In Line Exhaust Fan?

In Line exhaust fans are installed in the roof space above (or slightly away) from the area of installation. Many choose to have an inline fan because of its flexibility in being able to be mounted anywhere in the roof space above the room. Further to this, because it doesn't have to be mounted directly on the room, inline fans can be a very quiet ventilation solution.

**Please note: this product is not designed to be used in conjunction with gas heaters.**

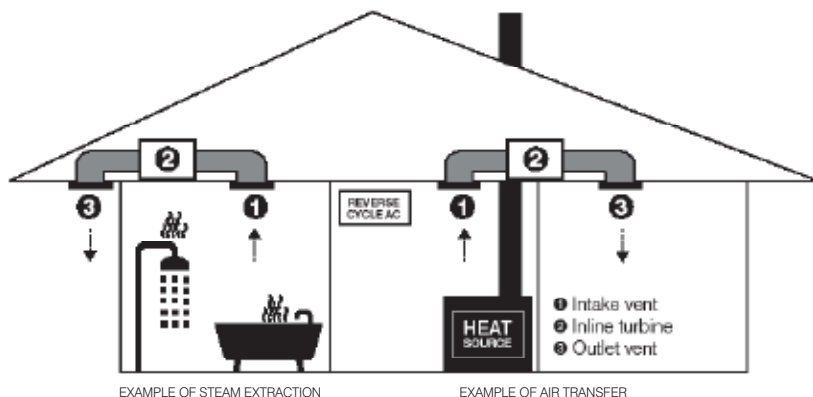

## Ingress Protection Rating Explained

An IP rating stands for Ingress Protection. In easy terms, it's a rating that states how protected the product is against water or dust getting into its casing, or how resistant it is to impacts. Generally speaking, the higher the number equals better protection.

The turbine air transfer motor has an IPX4 rating. This means that it is suitable for steam extraction.

**IPX4  
RATING**

# TURBINE 200

## INLINE AIR TRANSFER AND EXHAUST FAN



- Powerful 120W motor with axial fan.
- IPX4 rated.
- Ball bearing motor.
- Ø200mm duct inlet/outlet size.
- Requires a switched surface socket for DIY installation.

### INCLUDED IN THE BOX

- 1 x 120W inline exhaust fan
- 2 x 3m aluminium single layer ducting
- 2 x white round grille
- 4 x ring clamps

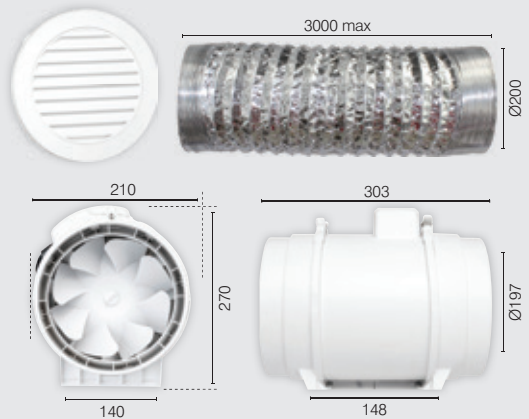

DETAILS		EXHAUST				
MODEL NO.	COLOUR	BLADE SIZE (MM)	NOISE (dB)	m <sup>3</sup> /min	m <sup>3</sup> /hr	L/sec
20400/05	White	192	≤68	≤15	≤900	≤250

# WALL EXHAUST



# SENSA-FLOW

## SQUARE WALL/WINDOW EXHAUST FAN WITH PIR SENSOR

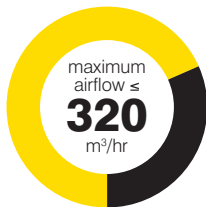

Square design wall or window exhaust fan.

### FEATURES

- P.I.R. motion sensor.
- Subsequent/new movement will restart the ON time (1 minute).
- Integrated fly-proof net.
- Ball bearing motor.
- Quiet operation.
- Mounting kit included.
- Fastening ring for window installation
- Backdraft shutter.
- Includes 40cm 2-wire lead for hardwired installation.
- 3 year replacement warranty.

### ACCESSORIES (Sold separately)

- 3m Ø150mm aluminium duct 19939
- 6m Ø150mm aluminium duct 19940

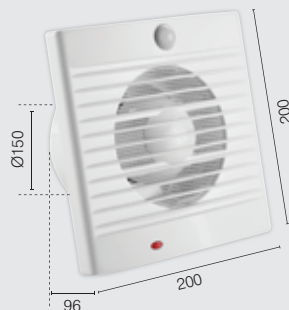

DETAILS		EXHAUST					
MODEL NO.	COLOUR	BLADE SIZE (mm)	RPM	NOISE (dB)	m <sup>3</sup> /min	m <sup>3</sup> /hr	L/sec
19934/05	White	135	2000	$\leq 35$	$\leq 5.3$	$\leq 320$	$\leq 89$

# HEATED TOWEL RAILS & VANITY LIGHTS



# HEATED TOWEL RAIL

AVAILABLE AS DIY PLUG AND CORD OR HIDDEN WIRING

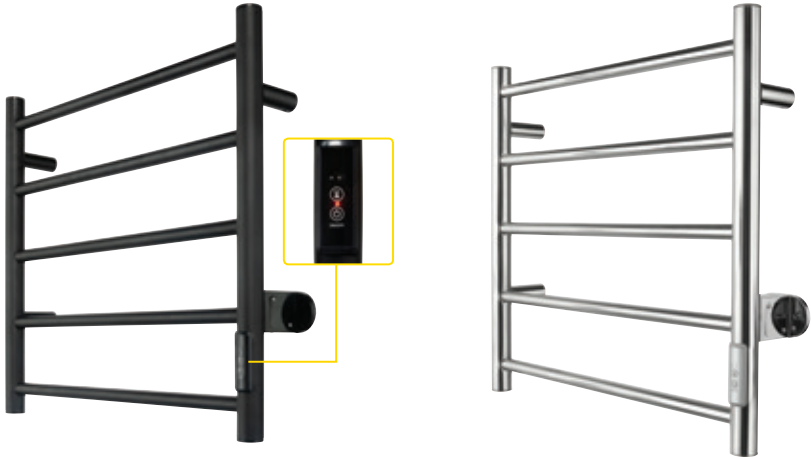

**65W**  
BLACK

**50W**  
CHROME



**5YR**  
WARRANTY

20796 ONLY

Our heated towel rail is all about comfort, whilst creating a modern and contemporary looking bathroom. They provide practical function and compact design offering space in even the most compact of rooms.

## FEATURES

- 2 or 4 hour timer
- 5 Bar towel rail
- All fixing accessories included.
- Easily installed into new or existing homes.
- Made from high grade carbon steel (Black) or polished 201 stainless steel (Chrome).
- Offers right-hand side wiring only.
- 5 year replacement warranty.

MODEL NO.	COLOUR
<b>DIY with 1m flex &amp; plug</b>	
20796/06	Matt Black
20796/16	Chrome
<b>Hidden wiring (hardwired)</b>	
20845/06	Matt Black
20845/16	Chrome



# GRETA-II

## LED SLIMLINE VANITY LIGHT

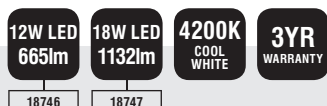

- Slimline adjustable vanity light.
- Smart silver finish.
- Specifically designed for use in bathrooms, kitchens, laundries or powder-rooms.
- Adjustable (rotating) head.
- Non-dimmable high lumen integrated LED array
- Acrylic diffuser to minimise shadows whilst providing ample light.

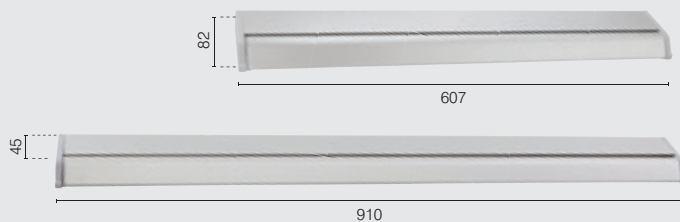

MODEL NO.	COLOUR	WATTAGE (W)	LUMENS (lm)	LED ARRAY
18746/11	Silver	12	800	60 x SMD
18747/11	Silver	18	1200	90 x SMD





**12W LED**  
**800lm**

**4200K**  
**COOL**  
**WHITE**

**3YR**  
**WARRANTY**

- Stylish slimline vanity light.
- Smart silver finish.
- Specifically designed for use in bathrooms, kitchens, laundries or powder-rooms.
- Non-dimmable high lumen integrated LED array.
- Reeded acrylic diffuser to minimise shadows whilst providing ample light.



MODEL NO.	COLOUR	WATTAGE (W)	LUMENS (lm)	LED ARRAY
18743/11	Silver	12	800	60 x SMD

# BABYLON

## LED VANITY LIGHT



Also available in a matt white finish

12W LED  
1300lm

18W LED  
1900lm

3000K  
WARM  
WHITE

CRI  
> 81

IP44  
RATING

3YR  
WARRANTY

20732

20733

- Contemporary style to suit most bathrooms.
- Matt Black or Matt White finishes.
- Acrylic diffuser to minimise shadows whilst providing ample light.
- IP44 water-resistant rated.
- Non-dimmable high lumen integrated SMD LED array.
- Made from aluminium, iron and acrylic components.
- 3 Year Warranty.

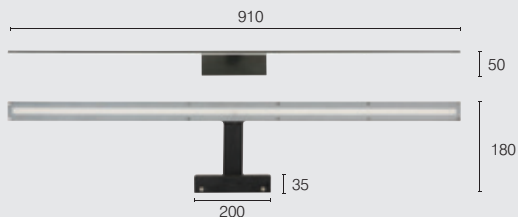
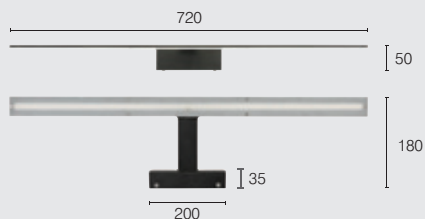

MODEL NO.	WATTAGE (W)	LUMENS (lm)	COLOUR
20732/05	12	1300	Matt White
20732/06	12	1300	Matt Black
20733/05	18	1900	Matt White
20733/06	18	1900	Matt Black



Also available in a chrome finish

**15W  
LED**

**20W  
LED**

**3000K  
WARM  
WHITE**

**CRI  
>72**

**IP20  
RATING**

**3YR  
WARRANTY**

20734

20735

- Contemporary style to suit most bathrooms.
- Matt Black or Chrome finishes.
- Polycarbonate diffuser to minimise shadows whilst providing ample light.
- IP20 water-resistant rated.
- Non-dimmable high lumen integrated SMD LED array.
- Made from aluminium, iron and polycarbonate components.
- 3 Year Warranty.

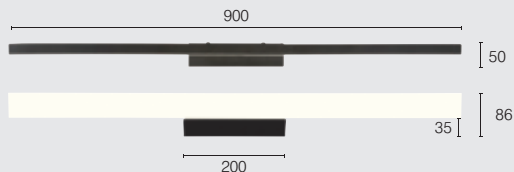
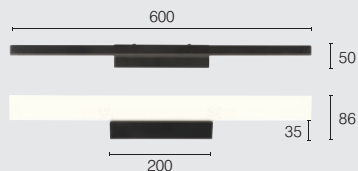

MODEL NO.	WATTAGE (W)	LUMENS (lm)	COLOUR
20734/15	15	1000	Chrome
20734/06	15	900	Matt Black
20735/15	20	1700	Chrome
20735/06	20	1500	Matt Black

# ACCESSORIES – DUCTING

## ALUMINIUM ACCESSORY



- Choose the correct size duct to suit your exhaust fan and vent for best result.
- Cut-off any excess duct once the duct is extended to its required length.
- Secure the duct with clamps or tape (not included)
- Elbows and turns should be kept to a minimum.



MODEL NO.	COLOUR	SUITS DIAMETER (mm)	SUITS DIAMETER (in)	LENGTH (M)
19937	Aluminium	Ø100	Ø4	3
19939	Aluminium	Ø150	Ø6	3
19940	Aluminium	Ø150	Ø6	6

# ACCESSORIES – EXTERIOR COWL

## DUCTING ACCESSORY



- 304 grade Stainless steel Dome vent.
- Suitable for external wall installations.
- This vent comes with a fly-proof mesh.
- Available 100mm to suit duct size.

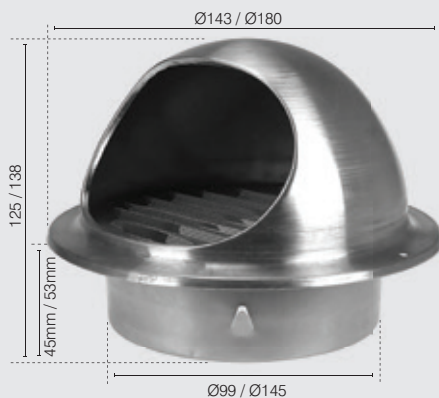

MODEL NO.	COLOUR	SUITS DIAMETER (mm)	SUITS DIAMETER (in)
19943/16	Stainless Steel 304	Ø100	Ø4





# EXTERIOR

Classic and  
contemporary lighting to  
brighten any outdoor area

# BOLTON

## LED WALL LIGHT



12W LED  
670lm

4000K  
COOL  
WHITE

IP44  
RATING

2YR  
WARRANTY

- Contemporary wall/bunker light.
- Die-cast aluminium frame.
- UV stabilised polycarbonate lens.
- IP44 weather-resistant rated.
- Integrated cool white energy saving LED array source.

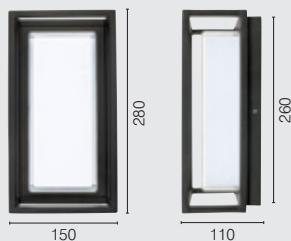

MODEL NO.	WATTAGE (W)	LUMENS (LM)	COLOUR TEMP (K)	COLOUR	DESCRIPTION
19689/06	12	670	4000	Black	Rectangle Wall





**60W  
MAX**



**IP54  
RATING**

**2YR  
WARRANTY**

- Contemporary curved wall light constructed from durable diecast aluminium with an open face and a tough polycarbonate lens.
- Allows light to go three directions, up, down and out.
- IP54 weatherproof rated.
- Uses E27 60W max globe (not included).



MODEL NO.	COLOUR	DESCRIPTION
17956/20	Brushed Aluminium	Wall

# DENVER II

## LED ADJUSTABLE WALL SPOTLIGHT



- Modern round design.
- Multi-directional adjustable heads.
- IP44 Weather resistant rated.
- Supplied with GU10 4W 300 lumen 3000K LED globes.

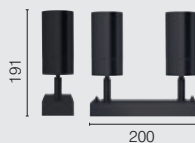

Make your light Smart by adding a Smart GU10 globe and connect to our BrilliantSmart app.

MODEL NO.	COLOUR	DESCRIPTION
17531/06	Black	2 Light Bar

# DENVER II

LED WALL LIGHT



**MAKE IT SMART**  
Add a Smart GU10 Globe  
See page 53/54



- Modern round design.
- IP44 Weather resistant rated.
- 304 stainless steel and black.
- Supplied with GU10 4W 300 lumen 3000K LED globes.



Make your light Smart by adding a Smart GU10 globe and connect to our BrilliantSmart app.

MODEL NO.	COLOUR	DESCRIPTION
17530/06	Black	Adjustable
17530/16	Stainless Steel 304	Adjustable
17529/06	Black	Up/Down





**2x35W  
MAX**

**GU10**  

**IP44**  
RATING

**2YR**  
WARRANTY

- Modern curved exterior wall light in either durable 304 stainless steel or powdercoated diecast aluminium.
- IP44 weatherproof rated.
- Uses GU10 35W max globe (not included).

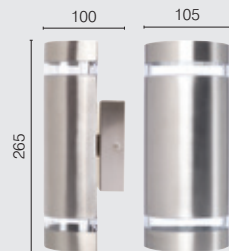

Make your light Smart by adding a Smart GU10 globe and connect to our BrilliantSmart app.

MODEL NO.	COLOUR	DESCRIPTION
<b>17943/16</b>	Stainless Steel (304)	Wall
<b>17943/51</b>	Charcoal	Wall

# DUBOIS II

## LED UP/DOWN WALL LIGHT



**9W LED**  
**500lm**

**3000K**  
WARM  
WHITE

**IP54**  
RATING

**2YR**  
WARRANTY

- Modern curved exterior.
- Powdercoated diecast aluminium construction.
- Tempered glass lens.
- Integrated LED light sources.
- Total of 500 lumens.
- IP54 weatherproof rated.

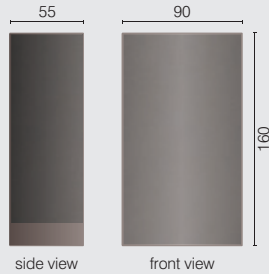

MODEL NO.	COLOUR	DESCRIPTION
19674/51	Charcoal	Wall



**18W  
MAX**

**E27**  

**IP44**  
RATING

**2YR**  
WARRANTY

- Contemporary exterior wall light range constructed from diecast aluminium with a powdercoated finish and a tough polycarbonate lens.
- IP44 weatherproof rated.
- Uses E27 18W max globe (not included).

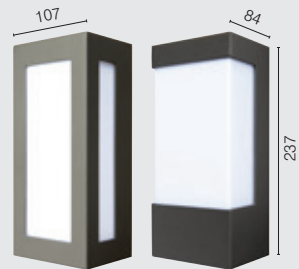

MODEL NO.	COLOUR	DESCRIPTION
<b>18048/51</b>	Charcoal	Lantern
<b>18049/51</b>	Charcoal	Wall

# ENTASIS

## EXTERIOR WALL LIGHT



**MAKE IT SMART**  
Add a Smart GU10 Globe  
See page 53/54

**2x35W  
MAX**

**GU10**  
RATING

**IP44**  
RATING

**2YR**  
WARRANTY

- Modern rectangular block exterior wall light in either durable 304 stainless steel or powdercoated diecast aluminium.
- IP44 weatherproof rated.
- Uses GU10 35W max globe (globe not included).

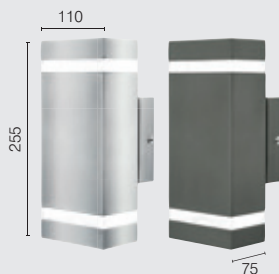

Make your light Smart by adding a Smart GU10 globe and connect to our BrilliantSmart app.

MODEL NO.	COLOUR	DESCRIPTION
17942/16	Stainless Steel (304)	Wall
17942/51	Charcoal	Wall



# EUPHRATES

LED WALL LIGHT



2x1.12W  
MAX

6400K  
DAY  
LIGHT

IP44  
RATING

2YR  
WARRANTY

- Wall light.
- Stainless steel construction.
- Clear round glass stepped diffusers.
- Integrated LED.
- IP44 weatherproof protection.



MODEL NO.	FITTING COLOUR	DESCRIPTION
18047/16	Stainless Steel	Wall

# GLENELG

## LED EXTERIOR WALL LIGHTS



**35W  
MAX**

**GU10**  
LED

**IP65  
RATING**

**3YR  
WARRANTY**

- Modern architectural decorative wall light ideal for illuminating pillars, side of doors, windows, steps or paths, garages and more.
- Durable diecast aluminium construction with a hard wearing powdercoated finish.
- Crystal clear tempered glass lens allows a crisp clean light.
- IP65 weather resistant rating.
- Uses 4W GU10 LED globes (supplied & fitted)  
– 300 lumens 3000K warm white.

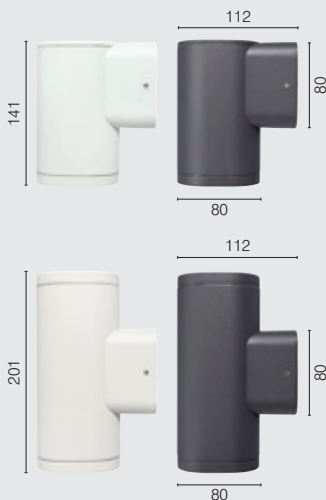

MODEL NO.	COLOUR	DESCRIPTION
<b>20775/05</b>	White	Fixed
<b>20775/51</b>	Charcoal	Fixed
<b>20777/05</b>	White	Up/Down
<b>20777/51</b>	Charcoal	Up/Down

# GLENELG AMBIENT

## LED EXTERIOR WALL LIGHTS



**35W  
MAX**

**GU10**  

**IP65  
RATING**

**3YR  
WARRANTY**

- Modern architectural decorative wall light forms a beautiful accent light plus an ambient glow.
- Durable diecast aluminium construction with a hard wearing powdercoated finish.
- Crystal clear tempered glass lens allows a crisp clean light.
- IP65 weather resistant rating.
- Uses 4W GU10 LED globes (supplied & fitted)  
– 300 lumens 3000K warm white.



MODEL NO.	COLOUR	DESCRIPTION
20779/05	White	Fixed
20779/51	Charcoal	Fixed
20781/05	White	Up/Down
20781/51	Charcoal	Up/Down



- Modern slim LED wall light creates a beautiful accent light perfect for illuminating pillars, side of doors, windows, steps or paths, garages and more.
- Hard wearing and UV stabilised polycarbonate construction durable enough for outdoor installations.
- 3W integrated LED chip that sheds up to 130 lumens in a 3000K warm white colour temperature.
- IP65 weather resistant rating.



MODEL NO.	COLOUR	DESCRIPTION
20807/51	Charcoal	Down



**2x9W  
MAX**



**IP44  
RATING**

**2YR  
WARRANTY**

- Modern energy saving exterior wall lights constructed from 304 stainless steel, in up/down configuration.
- IP44 weatherproof protection.
- Uses GU10 9W max globe (not included).

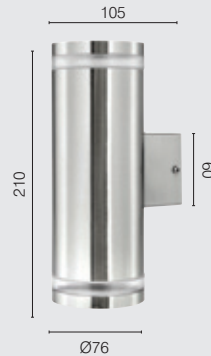

Make your light Smart by adding a Smart GU10 globe and connect to our BrilliantSmart app.

MODEL NO.	COLOUR	DESCRIPTION
18031/16	Stainless Steel (304)	Wall





**35W  
MAX**

**GU10**  

**IP65  
RATING**

**3YR  
WARRANTY**

- Durable Anodised Aluminium or Marine Grade 316 Stainless Steel
- Ideal for coastal areas
- Supplied with GU10 4W 300 lumen Warm White LED globe/s.
- Wall or ceiling mountable
- IP65 weather resistant
- 240 Volt AC, 50Hz

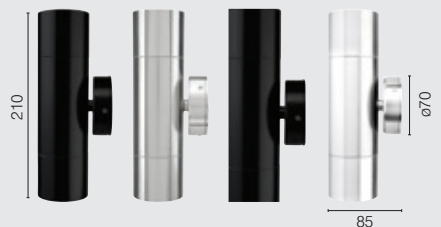
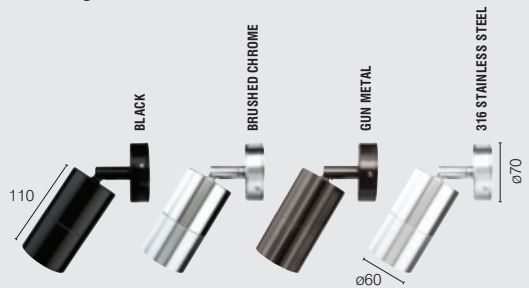

MODEL NO.	COLOUR	DESCRIPTION
20597/06	Black	Adjustable
20597/13	Brushed Chrome	Adjustable
20597/66	Gun Metal	Adjustable
20605/16	316 Stainless Steel	Adjustable
20601/06	Black	Up/Down
20601/13	Brushed Chrome	Up/Down
20601/66	Gun Metal	Up/Down
20607/16	316 Stainless Steel	Up/Down

# PRAIRIE

## WALL LIGHT



**2x11W  
MAX**

**GU10**  
BASE

**IP54  
RATING**

**2YR  
WARRANTY**

- Modern block style up/down wall light made from durable diecast aluminium.
- IP54 weatherproof rated.
- Uses GU10 11W max globe (not included).

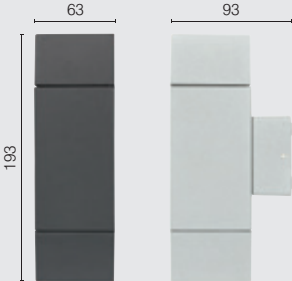

MODEL NO.	COLOUR	DESCRIPTION
17952/51	Charcoal	Wall



# VERNIER-II

## LED UP/DOWN WALL LIGHT



**9W LED**  
**500lm**

**3000K**  
WARM  
WHITE

**IP54**  
RATING

**2YR**  
WARRANTY

- Modern rectangular exterior.
- Powdercoated diecast aluminium construction.
- Tempered glass lens.
- 2 x Integrated LED light sources.
- Total of 500 lumens.
- IP54 weatherproof rated.

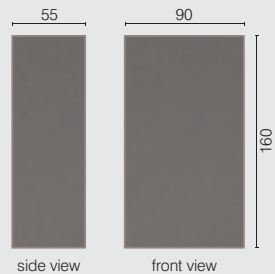

MODEL NO.	COLOUR	DESCRIPTION
19675/51	Charcoal	Wall

## COACH WALL LIGHT



- Durable powdercoated diecast aluminium with six clear bevelled glass panels.
- IP44 weatherproof rated.
- Uses E27 60W max globe (not included).



MODEL NO.	COLOUR	DESCRIPTION
17911/06	Black	Wall
17911/09	Beige	Wall

# ACHERON

## ARCHITECTURAL LED BUNKER LIGHT



**6W LED**  
**240lm**

**4000K**  
**COOL**  
**WHITE**

**2YR**  
**WARRANTY**

- Energy saving integrated LED.
- Modern rectangular architectural wall light.
- Durable diecast aluminium construction.
- Total of 240 lumens.
- IP44 weather-resistant rated.

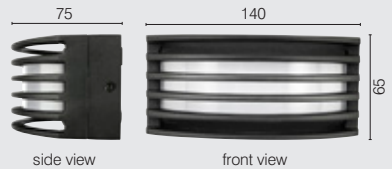

MODEL NO.	COLOUR	DESCRIPTION
19691/06	Black	Wall

# BEREA

## BUNKER LIGHT



- Modern styled wall light with diecast body and sealed poly-carbonate diffusers. Allows light to go in three directions, up, down and out through the front louvres.
- Uses E27 27W max globe (not included).

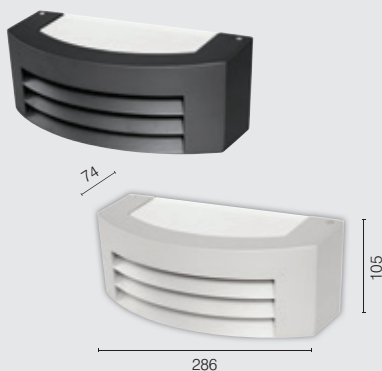

MODEL NO.	COLOUR	DESCRIPTION
99939/06	Black	Wall
99939/11	Silver	Wall



**12W MAX**  
**600lm**

**20W MAX**  
**800lm**

**3000K**  
**WARM**  
**WHITE**

**IP44**  
**RATING**

**3YR**  
**WARRANTY**

19692/51

19693/51

- Modern wall/bunker light.
- Durable diecast aluminium construction.
- Polycarbonate diffuser.
- IP44 Weather resistant rating.
- Integrated warm white energy saving LED light source.

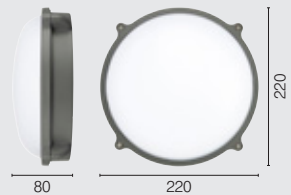
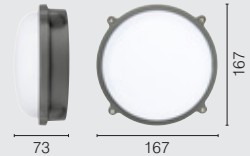

MODEL NO.	WATTAGE (W)	LUMENS (LM)	COLOUR TEMP (K)	COLOUR	DESCRIPTION
19692/51	12	600	3000	Charcoal	Small Wall
19693/51	20	800	3000	Charcoal	Large Wall

## OVAL LED BUNKER LIGHT



<b>7.5W</b> 500lm	<b>7.5W</b> 350lm	<b>3000K</b> WARM WHITE	<b>IP54</b> RATING	<b>3YR</b> WARRANTY
----------------------	----------------------	-------------------------------	-----------------------	------------------------

FULL	LOUVRED
------	---------

- Traditional oval bunker lights.
- Durable die-casting aluminium construction.
- Semi-frosted glass patterned diffuser.
- Energy saving LED.
- 7.5W warm white light.
- IP54 Weather resistant rating.

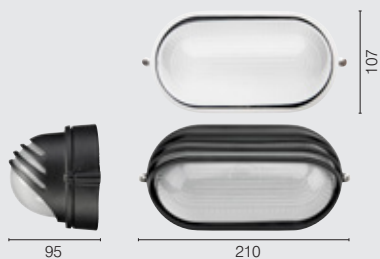

MODEL NO.	WATTAGE (W)	LUMENS (LM)	COLOUR TEMP (K)	COLOUR	DESCRIPTION
19929/05	7.5	500	3000	White	Full
19929/51	7.5	500	3000	Charcoal	Full
19930/05	7.5	350	3000	White	Louvred
19930/51	7.5	350	3000	Charcoal	Louvred



**10W MAX**  
750lm

**3000K**  
WARM  
WHITE

**IP54**  
RATING

**3YR**  
WARRANTY

- Modern round bunker light.
- Durable die-casting aluminium construction.
- Polycarbonate lens.
- Energy saving integrated LED.
- 10W / 750 lumen, warm white light.
- IP54 Weather resistant rating.



MODEL NO	COLOUR
19927/51	Charcoal

# HARDY LED

## LED VANDAL-PROOF POLYCARBONATE BUNKER



<b>12W</b> 800lm	<b>12W</b> 500lm	<b>4200K</b> COOL WHITE	<b>IK10</b>	<b>IP66</b> RATING	<b>2YR</b> WARRANTY
FULL		EYELID			

- Vandal-proof design using anti-tamper screws.
- Modern round bunker range made from tough UV stabilised polycarbonate with a opaque 2mm thick diffuser.
- Integrated LED.
- IP66 Weather resistant rating.
- Double Insulated.

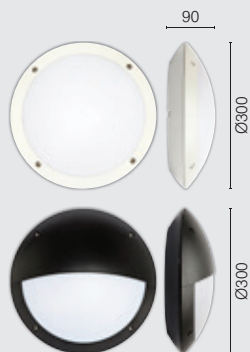

MODEL NO.	COLOUR	DESCRIPTION
<b>19971/05</b>	White	Full Wall
<b>19971/06</b>	Black	Full Wall
<b>19973/05</b>	White	Eyelid Wall
<b>19973/06</b>	Black	Eyelid Wall





**10W MAX**  
**650lm**

**3000K**  
WARM  
WHITE

**IP44**  
RATING

**3YR**  
WARRANTY

- Modern round slim design wall/bunker light.
- Wall or ceiling mountable.
- Durable die-casting aluminium construction.
- Energy saving integrated LED.
- 10W / 650 lumen, warm white light.
- IP44 Weather resistant rating.



MODEL NO.	COLOUR
19928/51	Charcoal

# COOPER

## LED ROUND STEP LIGHT

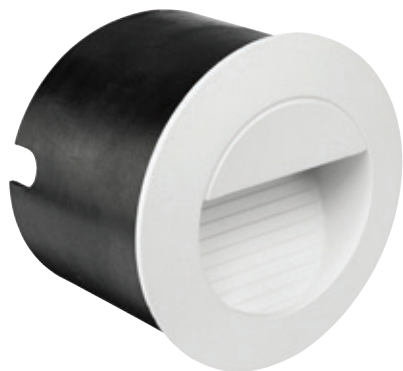

- Modern LED step light.
- Powdercoated diecast aluminium construction.
- Energy saving integrated LED.
- IP44 weatherproof rated.
- 77mm cut-out.

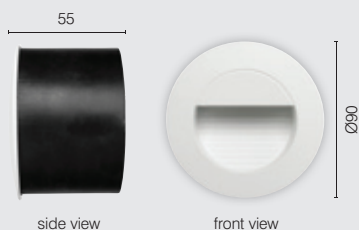

MODEL NO.	WATTAGE (W)	LUMENS (LM)	COLOUR	DESCRIPTION
19698/05	1.2	40	White	Step light

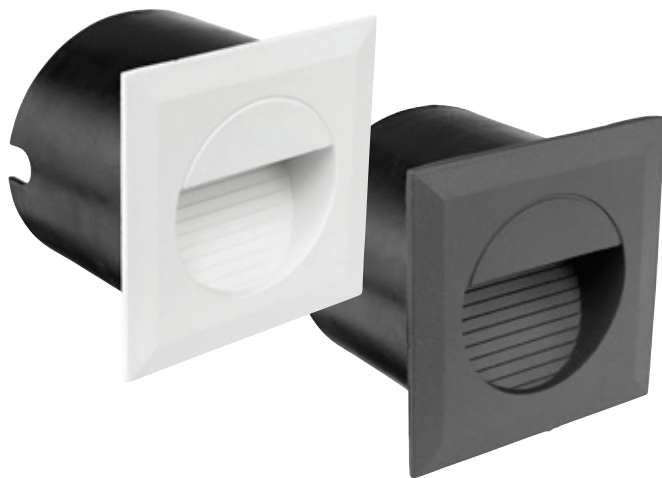

**1.2W**

**4000K**  
COOL  
WHITE

**IP44**  
RATING

**2YR**  
WARRANTY

- Modern LED step light.
- Powdercoated diecast aluminium construction.
- Energy saving integrated LED.
- IP44 weatherproof rated.
- 77mm cut-out.

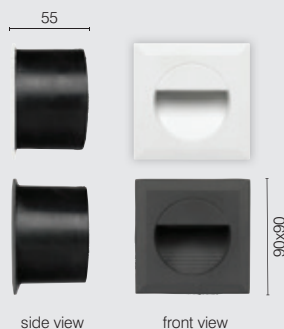

MODEL NO.	WATTAGE (W)	LUMENS (LM)	COLOUR	DESCRIPTION
<b>19696/05</b>	1.2	40	White	Step light
<b>19696/51</b>	1.2	20	Charcoal	Step light





# SECURITY

Light up outdoor areas to  
give you peace of mind



# SMART SECURITY RANGE



**HANDY SMART WIFI SENSOR CAMERA**  
20715/05



CONNECT  
TO OTHER  
SECURITY  
DEVICES  
VIA APP

**SMART WIFI REED SWITCH**  
20714/05



**SMART WIFI SIREN ALARM**  
20712/05



**SMART WIFI PIR SENSOR**  
20708/05



**SMART WIFI DOORBELL**  
20761/06



ONLY WORKS IN  
CONJUNCTION  
WITH SMART  
WIFI/RF  
DOORBELL

**DOORBELL CHIME**  
20387/06



**BOXER SMART WIFI OUTDOOR SENSOR**  
20707/06



**ESCORT SMART WIFI OUTDOOR LIGHT  
WITH SENSOR** 20700/06

 **WiFi**  
**NO HUB  
REQUIRED**

Have full control of your smart devices  
via the BrilliantSmart App, or via  
voice control with Google and Alexa.



**SWIFT SMART WIFI PAN & TILT CAMERA**  
20801/05



**MIA SMART WIFI CAMERA**  
21437/05



**PATROL SMART WIFI PAN & TILT  
OUTDOOR CAMERA** 21438/05



**ZIP SMART WIFI RECHARGEABLE  
OUTDOOR CAMERA** 21436/05



**TRIDENT SMART WIFI SOLAR  
OUTDOOR CAMERA** 21007/05



**BEAMER SMART WIFI FLOODLIGHT  
WITH OUTDOOR CAMERA** 20762/05



**SMART SECURITY KIT**  
21518

Works with  
**IFTTT**

WORKS WITH  
**alexa**

works with the  
**Google Assistant**



# AVENGER

## LARGE DIY LED FLOODLIGHT



200W  
4x50W  
14000lm

4200K  
COOL  
WHITE

IP65  
RATING

100°  
BEAM  
ANGLE



3YR  
WARRANTY

- Large commercial box style LED floodlights.
- Black painted outer casing and clear tempered safety glass lens.
- Adjustable bracket to direct floodlight.
- Do-It-Yourself installation.
- Supplied with 3-pin plug and 1m lead.
- Also available in 20W, 30W or 50W.

**APPROVALS (ENERGY SCHEME), VEET (ESC) 4473  
ESS (IPART) 99103S14LAWEDDG**

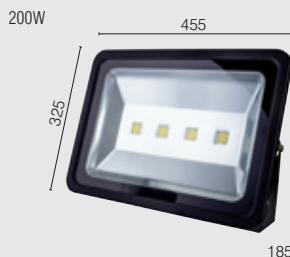

MODEL NO.	WATTAGE (W)	COLOUR
19135/06	200	Black





<b>20W</b> 2000lm	<b>30W</b> 3000lm	<b>50W</b> 5000lm	<b>4200K</b> COOL WHITE	<b>IP65</b> RATING	<b>DIY</b> INSTALLATION	<b>3YR</b> WARRANTY
19665/06 19667/06	19668/06 19669/06	19670/06 19671/06				

- Box style floodlight.
- High light output and energy efficient LED technology.
- 100 degree beam angle.
- Durable cast aluminium construction.
- Tempered glass lens.
- Adjustable mounting bracket.
- Easy DIY installation.
- Supplied with 3-pin plug and 1m lead.
- Suitable for residential and commercial use.
- Available in 20W, 30W or 50W.
- Lux setting, detection: 180°x12m, time on: 10s to 10min.

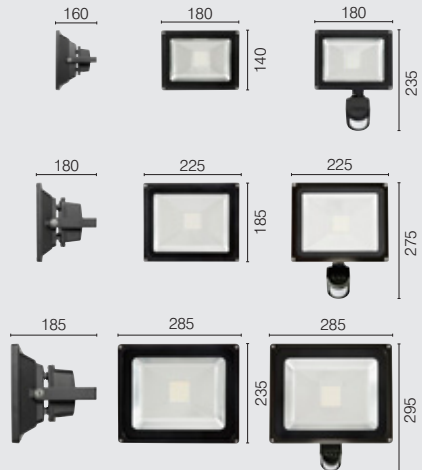

MODEL NO.	WATT (W)	COLOUR TEMP (°K)	LUMENS (lm)	SENSOR
19665/06	20	4200	2000	No
19667/06	20	4200	2000	Yes
19668/06	30	4200	3000	No
19669/06	30	4200	3000	Yes
19670/06	50	4200	5000	No
19671/06	50	4200	5000	Yes

# RAZOR

## LED FLOODLIGHT



- Industrial design LED floodlight.
- Rigid extruded aluminium housing.
- Durable powder coating.
- Do-It-Yourself installation.
- Easy adjustable mounting bracket.
- An IP65 weatherproof rated.



MODEL NO.	WATT (W)	COLOUR TEMP (°K)	LUMENS (lm)	COLOUR
20790/06	100	6000	9000	Black
20791/06	200	6000	17,000	Black



**11W**  
**750lm**

**22W**  
**1500lm**

**4200K**  
**COOL**  
**WHITE**

**IP44**  
**RATING**

**3YR**  
**WARRANTY**

1 Light

2 Light

- Modern LED floodlight.
- Ultra bright and long-life 11W COB LED chip.
- Produces 750 lumens per head.
- Made from durable diecast aluminium.
- Fully adjustable heads.
- Manual override
- IP44 Weatherproof rated.
- Lux setting, detection:150°x10m, time on:5s to 7min.



MODEL NO.	WATT (W)	COLOUR TEMP	LUMENS (lm)	SENSOR	COLOUR
19239/05	1 x 11	4200	750	No	White
19239/06	1 x 11	4200	750	No	Black
19239/13	1 x 11	4200	750	No	Satin Nickel
19975/05	1 x 11	4200	750	Yes	White
19975/06	1 x 11	4200	750	Yes	Black
19975/13	1 x 11	4200	750	Yes	Satin Nickel
19242/05	2 x 11	4200	1500	No	White
19242/06	2 x 11	4200	1500	No	Black
19242/13	2 x 11	4200	1500	No	Satin Nickel
19245/05	2 x 11	4200	1500	Yes	White
19245/06	2 x 11	4200	1500	Yes	Black
19245/13	2 x 11	4200	1500	Yes	Satin Nickel

# HUNTER TRIO

## LED CCT FLOODLIGHT

### TUNEABLE CCT

3000K — 6000K



1 Light | 2 Lights

- Adjustable sensor functions on time, light sensitivity (lux).
- Manual override available.
- Easily change colour temperature (CCT) from warm white 3000K, cool white 4200K to bright daylight 6000K.
- Latest in ultra-bright COB LED technology, with built-in 11W LEDs.
- Made from durable diecast aluminium.
- IP65 weather resistant for outdoor installation (floodlights)
- IP44 weather resistant ratd (sensor light).
- Quick and easy installation in 3 steps.
  1. Attach the base in to place
  2. Connect wiring to the quick connector on the base
  3. Slide the head on to the base and secure with the supplied nuts.

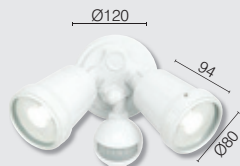

MODEL NO.	WATT (W)	LUMENS @ 3000K(lm)	LUMENS @ 4200K(lm)	LUMENS @ 6000K(lm)	SENSOR	COLOUR
20616/05	1 x 11	850	950	920	No	White
20616/06	1 x 11	850	950	920	No	Black
20622/05	2 x 11	1700	1900	1840	No	White
20622/06	2 x 11	1700	1900	1840	No	Black
20625/05	2 x 11	1700	1900	1840	Yes	White
20625/06	2 x 11	1700	1900	1840	Yes	Black



**10W**  
1100lm

**20W**  
2100lm

**4200K**  
COOL  
WHITE

**IP54**  
RATING

**3YR**  
WARRANTY

1 Light

2 Light

- Modern design LED floodlight.
- For wall and on the ceiling under the eaves.
- Made from durable UV stabilised polycarbonate.
- Ultra-bright and long-life 10W COB LED chip.
- Fully adjustable heads.
- Manual override.
- An IP54 weatherproof rated.
- Lux setting, detection: 150°x12m, time on: 10s to 5min.

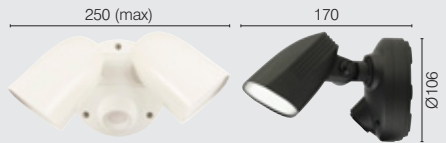

MODEL NO.	WATT (W)	COLOUR TEMP (°K)	LUMENS (lm)	SENSOR
20788/05	1 x 10	4200	1100	No
20788/06	1 x 10	4200	1100	No
20786/05	2 x 10	4200	2100	No
20786/06	2 x 10	4200	2100	No
20784/05	2 x 10	4200	2100	Yes
20784/06	2 x 10	4200	2100	Yes

## SOLAR LED SECURITY LIGHT WITH SENSOR



### Features:

- 7W 700 lumen LED light.
- Easy Do-It-Yourself Installation.
- Charge by placing in full sunlight.
- 3.7V 3600mAh Lithium-ion Battery.
- 1.8W Amorphous Solar Panel.
- 5m of cable connecting light to panel.
- Run Time: 1 hour when fully charged.
- Solar powered exterior security light made from durable UV stabilised ABS plastic with an adjustable head.
- Lux setting, detection: 130°x10m, time on: 10s to 1 min.



MODEL NO.	COLOUR
18362/06	Black



<b>20W</b> 1600lm	<b>50W</b> 3600lm	<b>100W</b> 9000lm	<b>4200K</b> COOL WHITE	<b>IP65</b> RATING	<b>DIY</b> INSTALLATION	<b>2YR</b> WARRANTY
19485/06	19489/06	19491/06				

- High light output and energy efficient LED technology.
- Durable cast aluminium housing.
- Adjustable arm.
- Easy DIY installation.
- Supplied with 3-pin plug and 1.2m lead.
- Suitable for residential and commercial use.
- Available in 20W, 50W or 100W.
- Lux setting, detection: 120°x8m, time on: 10s to 7min.

**APPROVALS (50W & 100W ONLY), ENERGY SCHEME, VEET (ESC) 4907, ESS (IPART) 99103S14-HGFJJBFG**

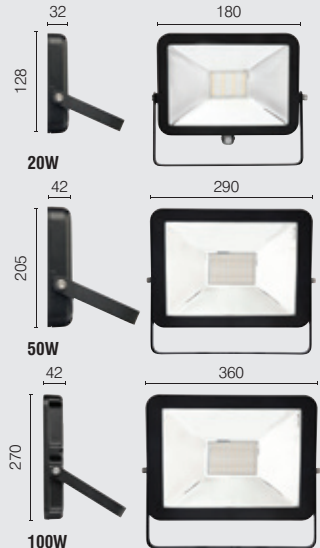

MODEL NO.	WATTAGE (W)	COLOUR TEMP (K)	LUMENS (lm)
19485/06	20	4200	1600
19489/06	50	4200	3600
19491/06	100	4200	9000







# SENSORS

Our range of sensors can detect  
movement of body heat and  
disturbance of radio waves

# SENSOR SELECTION

## PIR SENSOR

- Detects movement of body heat
- Detects best when movement is across the 'zones'
- Can only detect in line of sight
- Should be mounted 2.3–3.5m above the ground
- Suitable for indoor & outdoor

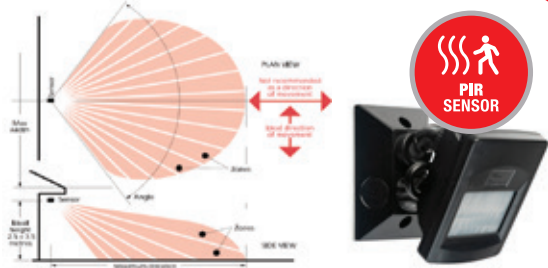

## MICROWAVE SENSOR

- Detects disturbance of radio waves generated by the sensor, similar to radar
- Detects movement from all directions
- Can penetrate most materials such as walls and ceiling plaster (except metal) – enabling invisible installation in ceiling
- Better sensitivity than PIR
- Ideal for indoor but suitable for outdoor at a reduced sensitivity level

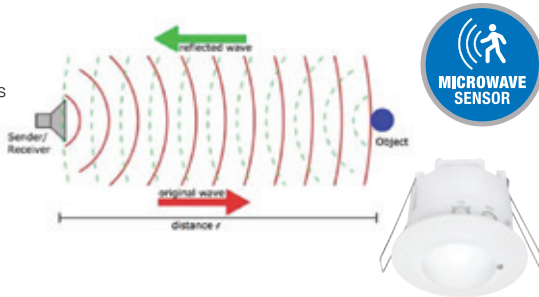

## SMART SENSOR

Have full control of your smart devices via the BrilliantSmart App, or via voice control with Google and Alexa.

Go to the BrilliantSmart section on page 4 for more info or visit:

**brilliantlighting.com.au**  
**or brilliantsmart.com.au**



**PIR SENSOR SMART WIFI SECURITY DEVICE – 20708/05**

# EYE 360°: SERIES II

RECESSED PIR SECURITY SENSOR



10s  
to 20m  
TIME ON

360°/9m  
DETECTION  
RANGE

Ø62mm

3YR  
WARRANTY

- Passive Infra-red technology.
- Multi-segmented lens for better detection.
- Reliable 3-wire design.
- Adjustable time and lux level.
- Manual override.
- Indoor use only.
- Resets to AUTO mode after 8 hours.
- Ceiling recessed flush mount.

Max Load : 2000W Incandescent lamp  
600W Fluorescent lamp  
300W LED lamp

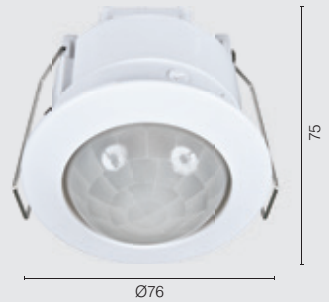

MODEL NO.	COLOUR
18063/05	White

# EYE 360° MICROWAVE

## RECESSED MICROWAVE SECURITY SENSOR



10s  
to 12m  
TIME ON

360°/16m  
DETECTION  
RANGE

Ø65mm

3YR  
WARRANTY

- Automatically activated by motion and light level.
- Ceiling recessed mount.
- Wide detection area, up to 16m in diameter.
- Motion can be detected through plastic, glass and thin non-metal materials.
- Adjustable time, lux level and detection area.
- Time delay 10s – 12min
- Reliable 3-wire design.
- Indoor use only.

HF system: 5.8GHz

Installation height: 1.5-3.5m

Lux control level: 3-2000LUX (adjustable)

Max Load: 1200W Incandescent lamp  
300W Fluorescent lamp  
150W LED lamp



MODEL NO.	COLOUR
20051/05	White

# EYE 360° MINI SERIES II

RECESSED PIR SECURITY SENSOR



**10s  
to 15m**  
TIME ON

**360°/6m**  
DETECTION  
RANGE

**Ø45mm**

**3YR**  
WARRANTY

- Passive Infra-red technology.
- Multi-segmented lens for better detection.
- Reliable 3-wire design.
- Adjustable time and lux level.
- Manual override.
- Ceiling recessed mount.
- Indoor use only.

Resets to AUTO mode after 8 hours.  
Lux control level: 3-2000LUX (adjustable)

Max Load: 800W Incandescent lamp  
400W Fluorescent lamp  
200W LED lamp

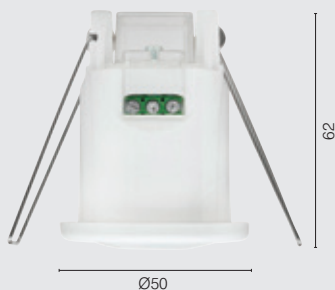

MODEL NO.	COLOUR
21353/05	White

# EZY-SCAN

## 180° PIR SECURITY SENSOR



**10s  
to 15m**  
TIME ON

**180°/12m**  
DETECTION  
RANGE

**IP44**  
RATING

**3YR**  
WARRANTY

- Passive Infra-red technology.
- Multi-segmented lens for better detection.
- Adjustable sensing angle.
- Reliable 3-wire design.
- Adjustable time and lux level.
- Manual override.
- IP44 weather-resistant rated.
- Resets to AUTO mode after 8 hours.
- Wall mount.

Lux control level: 3-2000LUX (adjustable).

Max Load: 800W Incandescent lamp  
400W Fluorescent lamp  
200W LED lamp

- Corner mounting bracket sold separately.

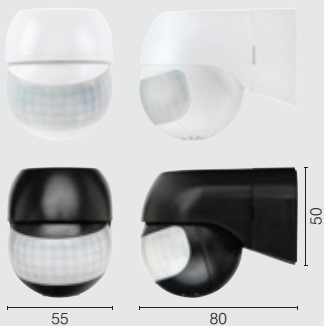

MODEL NO.	PRODUCT	COLOUR
<b>20044/05</b>	PIR Sensor	White
<b>20044/06</b>	PIR Sensor	Black
<b>20243/05</b>	Corner Mount	White
<b>20243/06</b>	Corner Mount	Black

# FLEXISCAN: SERIES II

110° PIR SECURITY SENSOR



**110°/18m**  
DETECTION  
RANGE

**IP66**  
RATING

**5YR**  
WARRANTY

- LED compatible.
- Passive Infra-red technology.
- Flexible adjustable arm.
- Multi-segmented optical lens for better detection.
- Reliable 3-wire design.
- IP66 weather-resistant rated.
- Easy to mount, wall or ceiling installation.
- Heavy duty switching circuitry, suitable for large loads.
- Adjustable time, sensitivity and lux level.
- Time delay 10s – 20min.
- Timer restart function\*.
- Manual override.
- Resets to AUTO mode after 8 hours

Max Load : 2400W Incandescent lamp  
1200W Fluorescent lamp  
300W LED lamp

Power consumption: 0.7W.

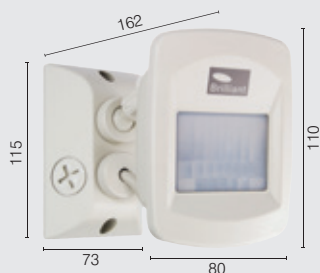

MODEL NO.	COLOUR
18562/06	Black
18562/09	Beige

\*Time restarts after any subsequent detection.

# RETRO-FIT MICROWAVE

## CEILING/WALL LIGHT MICROWAVE SECURITY SENSOR



**180°/15m**  
DETECTION RANGE

**360°/8m**  
DETECTION RANGE

**3YR**  
WARRANTY

WALL | CEILING

- Automatically activated by motion and light level.
- Compact size to retro-fit into most ceiling and wall lights.
- Wide detection area.
- Motion can be detected through plastic, glass and thin non-metal materials.
- Accurate adjustable time, lux level and detection area via DIP switches.
- Reliable 3-wire design.
- Time delay 5s, 30s, 90s, 3min, 5min, 10min.

HF system: 5.8GHz

Lux control level: < 3-2000LUX (adjustable)

Installation height: Wall 1.5-3.5m  
Ceiling 2-6m

Detection range: Wall 180 degrees  
Ceiling 360 degrees

Detection distance: Wall 5-15m (adjustable)  
Ceiling 1-8m radius (adjustable)

Max Load: 1200W Incandescent lamp  
300W Fluorescent lamp  
150W LED lamp

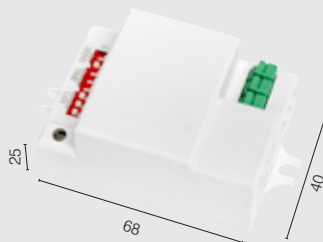

MODEL NO.	COLOUR
20052/05	White



# TECHNO-SCAN 360°

## SURFACE MOUNT PIR SECURITY SENSOR



**10s  
to 30m  
TIME ON**

**360°/6m  
DETECTION  
RANGE**

**3YR  
WARRANTY**

- Passive Infra-red technology.
- Multi-segmented lens for better detection.
- Easy control via remote.
- Reliable 4-wire design (L,N in; L,N out).
- Time adjustable – 10sec – 30min max.
- Adjustable time, lux level and detection range.
- Timer restart function.
- Remote control included.
- Indoor use only.
- Resets to AUTO mode after 8 hours.
- Ceiling flush mount.
- Installation height: 2.2 - 4m (max).
- Lux control level: 3-2000LUX (adjustable).
- Max Load: 2000W Incandescent lamp  
1000W Fluorescent lamp  
500W LED lamp



MODEL NO.	COLOUR
20049/05	White

# THREE-SIXTY: SERIES II

## 360° SURFACE MOUNT PIR SENSOR



**10s  
to 20m**  
TIME ON

**360°/9m**  
DETECTION  
RANGE

**3YR**  
WARRANTY

- Passive Infra-red technology.
- Multi-segmented lens for better detection.
- Reliable 3-wire design.
- Time adjustable – 10sec – 20min max.
- Adjustable time and lux level.
- Manual override.
- Indoor use only.
- Resets to AUTO mode after 8 hours.
- Ceiling surface mount.

Max Load : 1600W Incandescent lamp  
500W Fluorescent lamp  
200W LED lamp



MODEL NO.	COLOUR
18062/05	White

# UNI-SCAN: SERIES II

180° PIR SECURITY SENSOR



**10s  
to 20m**  
TIME ON

**180°/12m**  
DETECTION  
RANGE

**IP44**  
RATING

**3YR**  
WARRANTY

- Passive Infra-red technology.
- Multi-segmented lens for better detection.
- Reliable 3-wire design.
- Adjustable time and lux level.
- Manual override.
- LED Compatible.
- IP44 weather-resistant rated.
- Wall or ceiling surface mount.
- Resets to AUTO mode after 8 hours.
- Timer restart function.

Max Load : 1000W Incandescent lamp  
300W Fluorescent lamp  
150W LED lamp

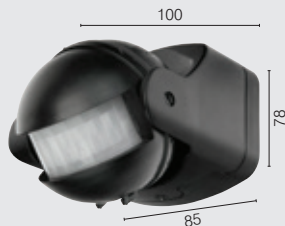

MODEL NO.	COLOUR
<b>18060/05</b>	White
<b>18060/06</b>	Black

# VERSA-SCAN

## 180° PIR SECURITY SENSOR



**10s  
to 15m**  
TIME ON

**180°/12m**  
DETECTION  
RANGE

**IP65**  
RATING

**3YR**  
WARRANTY

- Passive Infra-red technology.
- Multi-segmented lens for better detection.
- Adjustable sensing angle.
- Reliable 3-wire design.
- Adjustable time and lux level.
- Time delay 10s - 15min
- Manual override.
- IP65 weather-resistant rated.
- Resets to AUTO mode after 8 hours
- Wall mount.

Lux control level: 3-2000LUX (adjustable)

Max Load: 1200W Incandescent lamp  
300W Fluorescent lamp  
150W LED lamp

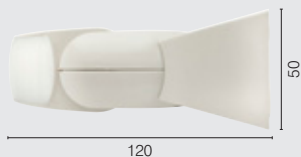

120

50

80

MODEL NO.	COLOUR
20046/08	Grey
20046/09	Beige

### 1. Can we wire two or more Brilliant sensors in parallel?

Yes. Each model in our range of stand alone sensors can be wired in parallel to additional sensors so that one or multiple loads can be turned on by different sensors. Refer basic wiring example below.

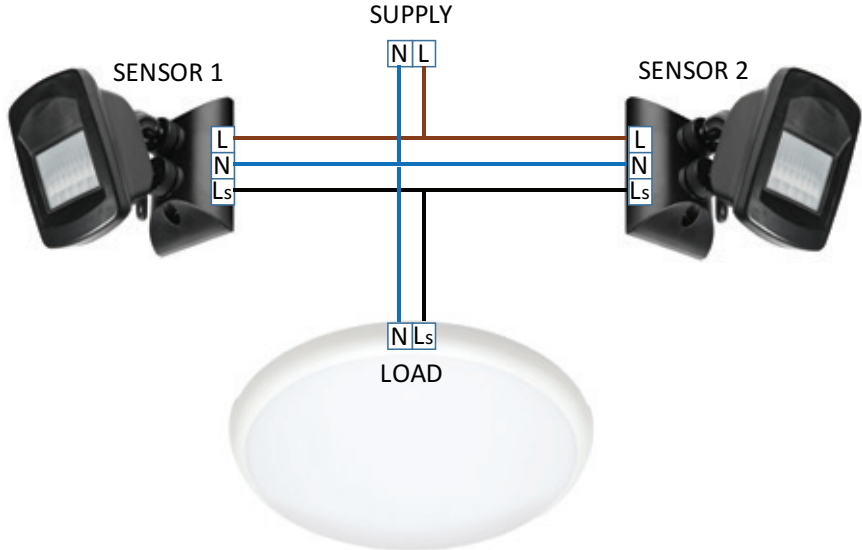

### 2. What is the minimum load of Brilliant sensors?

All Brilliant stand alone sensors have no actual minimum load (due to using a relay to switch the output). But as a guide we recommend at least a 5W load.

### 3. Do Brilliant sensors feature manual override?

Yes. Flexiscan 2, Uni Scan, Eye, Three Sixty 2, Ezy-Scan, Versa-Scan, Techno-Scan and Eye 360.

All feature manual override.

### 4. How to set sensor to manual override.

A – Flexiscan 2, with power already on, turn power switch off then back on within 2-3 seconds.

B – Techno-scan – simply select on via remote control!

C – For all other models, with power already on, turn power switch off then back on then off and back on again within 3 seconds.

### 5. HOW TO RETURN SENSOR INTO AUTOMATIC MODE.

Turn off power to sensor for at least 1 minute, then turn back on.





# GARDEN

We have a large range of garden  
lighting to suit all your needs



# SMART GARDEN RANGE



PACK INCLUDES:



**BOTANIC SMART WIFI RGB 4 PACK GARDEN LIGHT KIT** – 20702/06

**ACCESSORY – BOTANIC BLACK RGB GARDEN LIGHT WITH SPIKE** – 20703/06



RGB  
4 PIN DC  
OUTPUT

SINGLE  
COLOUR  
2 PIN DC  
OUTPUT

12V DC  
INPUT

**BOTANIC SMART WIFI RGB CCT GARDEN CONTROLLER** – 20701/06

 **WiFi**  
**NO HUB  
REQUIRED**

Have full control of your smart devices via the BrilliantSmart App, or via voice control with Google and Alexa.

Go to the BrilliantSmart section on page 4 for more info or visit:

[brilliantlighting.com.au](http://brilliantlighting.com.au)  
or [brilliantsmart.com.au](http://brilliantsmart.com.au)







**PLUG&PLAY**

**12V**

**5W  
300lm**

**WARM  
WHITE**

**IP44  
RATING**

**DIY**

**2YR  
WARRANTY**

- Modern outdoor garden spotlight.
- Heavy-duty spike for quick and easy installation.
- Durable Die-cast construction.
- Energy saving LED.
- Light with 300mm 0.8mm<sup>2</sup> cable and easy-to-use quick-clip connector.
- 5W/300lm Warm White per head.
- IP44 weather resistance.
- 12V AC/DC.
- Requires 12V LED transformer & power cable (sold separately).



Available 12V power supply compatible with this light::

- AC power supply: 60501, 60503, 60505, 60507, 60509, 17913, 17914
- DC power supply: 19915, 19916, 19917
  - Extension cable for DC power supply is 19918

MODEL NO.	COLOUR	DESCRIPTION
19921/06	Black	Garden Spotlight

# SOMERSET

## ECO 12V LED PATH LIGHT

**PLUG&PLAY**

**12V**

**2W  
150lm**

**WARM  
WHITE**

**IP44  
RATING**

**DIY**

**1YR  
WARRANTY**

- Classic outdoor path light.
- Heavy-duty stake for quick and easy installation.
- Durable full-metal construction powder coated.
- Energy saving LED.
- Includes 300mm 0.8mm<sup>2</sup> cable and easy-to-use quick-clip connector.
- 2W/150lm Warm White.
- IP44 weather resistance.
- 12V AC/DC.
- Requires 12V LED transformer & power cable (sold separately).

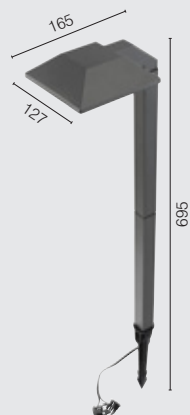

Available 12V power supply compatible with this light::

- AC power supply: 60501, 60503, 60505, 60507, 60509, 17913, 17914
- DC power supply: 19915, 19916, 19917
  - Extension cable for DC power supply is 19918

MODEL NO.	COLOUR	DESCRIPTION
19925/51	Charcoal	Path Light



- Modern outdoor brick, step or stair light.
- Flush mounting system.
- Durable metal construction powder coated.
- Energy saving LED.
- Includes 300mm 0.8mm<sup>2</sup> cable and easy-to-use quick-clip connector.
- LED 1W/20 lumen Cool White.
- IP44 weather resistance.
- Supply: 12V AC/DC.
- Requires transformer & power cable (sold separately).

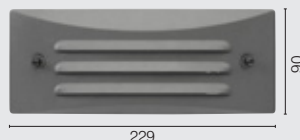

Available 12V power supply compatible with this light::

- AC power supply: 60501, 60503, 60505, 60507, 60509, 17913, 17914
- DC power supply: 19915, 19916, 19917
  - Extension cable for DC power supply is 19918

MODEL NO.	COLOUR	DESCRIPTION
19923/51	Charcoal	Step light



- Contemporary outdoor step or stair light.
- Concealed universal surface mounting system.
- Durable Die-cast Aluminium construction.
- Energy saving LED.
- Includes 300mm 0.8mm<sup>2</sup> wire and easy-to-use quick-clip connector.
- 2W/50lm Warm White.
- IP44 weather resistance.
- 12V AC/DC.
- Requires 12V transformer & power cable (sold separately).



MODEL NO.	COLOUR	DESCRIPTION
19924/51	Charcoal	Step light

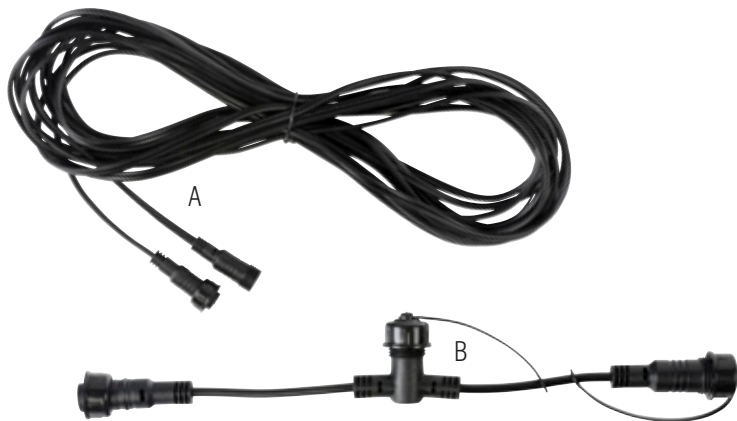

**PLUG&PLAY**

**12V** **DIY**

### EXTRA LOW VOLTAGE GARDEN LIGHT CABLE – 10m

- Standard duty 0.8mm<sup>2</sup>.
- With male/female connector.
- Female side with end cap.
- To be used with the transformer 60W and under.

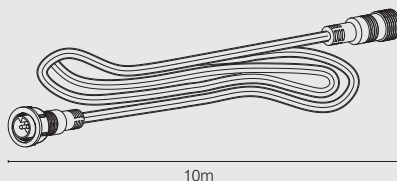

### EXTRA LOW VOLTAGE GARDEN LIGHT CABLE 2 WAY SPLITTER

- Standard duty 0.3mm<sup>2</sup> 300mm.
- With one male & two female connectors.

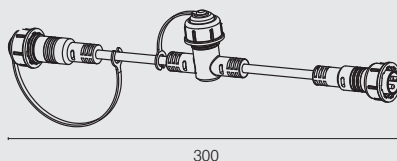

MODEL NO.	LENGTH	DESCRIPTION	IMAGE
19918/06	10m	Cable	A
19919/06	30cm	2-Way Splitter Cable	B

# DRIVER 12V DC

EXTERIOR/GARDEN



24W



36W



19915/06

19916/06

- ELV 240V/12V DC LED transformer.
- Suitable for indoor & outdoor use.
- Ideal for use with low-voltage LED garden lighting.
- Easy DIY installation via quick connector.
- IP68 weather resistance.
- Input: 100-240V AC 50/60Hz.
- Output: 12V DC, 2A/24W; 3A/36W; 5A/60W.
- Including plug and 2m flex.
- Supplied with 200mm 0.5mm<sup>2</sup> garden cable stripped.

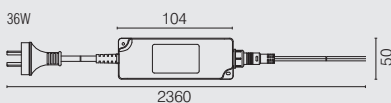
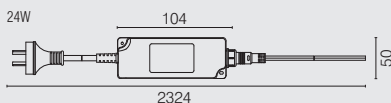

MODEL NO.	OUTPUT 12 DC	DESCRIPTION	IMAGE
19915/06	2A/24W	Transformer	A
19916/06	3A/36W	Transformer	B

# TRANSFORMER 12V AC

EXTERIOR/GARDEN SUITABLE FOR 12V



**150W  
MAX**

**200W  
MAX**

**300W  
MAX**

**400W  
MAX**

**500W  
MAX**

**IP66  
RATING**

**DIY**

**3-5YR  
WARRANTY**

60501 | 60503 | 60505 | 60507 | 60509

- ELV 12V transformer with IP66 weatherproof rating. 240V 2.0m lead with plug. Suitable for outdoor use, all types of garden, pond and entertainment areas. No electrician needed. Self resetting thermal overload protection.
- Comes with 2 x 5mm<sup>2</sup> 250mm long secondary cable and 2 x 16mm<sup>2</sup> terminal block.

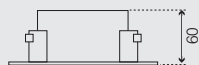

60501

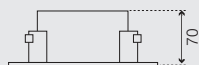
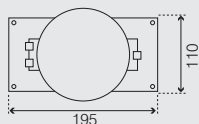

60503/60505

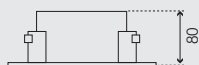
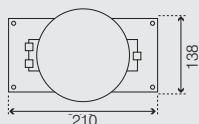

60507/60509

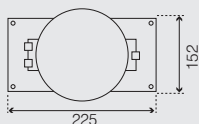

MODEL NO.	VA(W)	DESCRIPTION
60501	150	Transformer
60503	200	Transformer
60505	300	Transformer
60507	400	Transformer
60509	500	Transformer

# TRANSFORMER 12V AC

EXTERIOR/GARDEN SUITABLE FOR 12V



- ELV 12V transformer with IP65 weatherproof rating. 240V 2.0m lead with plug. Ideal for use with low-power LED garden lighting. Suitable for indoor and outdoor use, for all types of garden, pond and entertainment areas. No electrician needed. Self resetting thermal overload protection.
- Comes with 0.25m long 2 x 0.8mm<sup>2</sup> connection cable fitted with 2 x 4mm<sup>2</sup> terminal block.

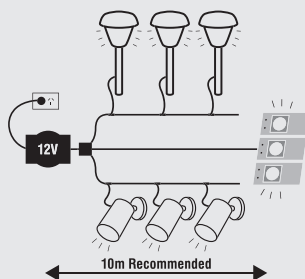

MODEL NO.	VA(W)	DESCRIPTION
17913	30	Transformer
17914	60	Transformer





# DENVER-II

## ECO GARDEN SPIKE



- Extra low voltage garden spikes.
- Modern round design.
- IP44 Weather resistant rated.
- 304 stainless steel finish.
- Requires 12V transformer and MR16 20W max. globe (not included).



MODEL NO.	DESCRIPTION	COLOUR
19399/16	Spike Single	Stainless Steel 304
19400/16	Spike Twin	Stainless Steel 304



- Stylish low voltage garden spotlight. Constructed of die-cast aluminium with a non-corroding polycarbonate spike.
- IP44 Weather-resistant rated.
- Adjustable head.
- 12V 50W MR16.
- 2-core 0.9m cable.
- Requires a 12V transformer (not included).
- Junction box for serial connection available separately from retailer.



MODEL NO.	COLOUR	DESCRIPTION
73120/06	Black	Garden Spike



- Modern adjustable garden spike, made from high quality 304 stainless steel.
- 2 x 1mm<sup>2</sup> cable, 0.4m length (included)
- Requires a 12V transformer (not included).



MODEL NO.	COLOUR	DESCRIPTION
60600/16	Stainless Steel (304)	Spike



- Low voltage adjustable garden spike with an IP65 weatherproof rating.
- Comes with 0.3m cable and junction box fitted with terminal block.
- Requires a 12V transformer (not included).



MODEL NO.	COLOUR	DESCRIPTION
60100/20a	Anodised Aluminium	Spike



**240V**

**22W  
MAX**

**E27**  

**IP44  
RATING**

**2YR  
WARRANTY**

- 600mm bollard.
- 304 stainless steel construction.
- Tough opal polycarbonate diffuser.
- IP44 weatherproof protection.
- Uses E27 22W max globe (not included).

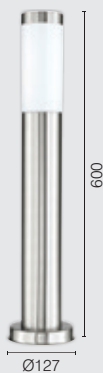

MODEL NO.	COLOUR	DESCRIPTION
<b>18043/16</b>	Stainless Steel (304)	Bollard



240V

22W  
MAX

E27  

IP44  
RATING

2YR  
WARRANTY

- Stainless steel construction.
- Louvred design with a tough polycarbonate diffuser.
- Energy saver globe compatible.
- IP44 weatherresistant rating.
- Uses E27 candle or fancy round 22W max globe (Max 50mm diameter. Globe not included).



MODEL NO.	COLOUR	DESCRIPTION
18051/16	Stainless Steel	Bollard







# CEILING & WALL

Create ambience in any  
room with our Brilliant  
range of lights to  
suit all decor



# SMART CEILING LIGHT RANGE



**CORDIA SMART WIFI CCT OYSTER**  
20717/05

 **WiFi**  
**NO HUB  
REQUIRED**

Have full control of your smart devices  
via the BrilliantSmart App, or via  
voice control with Google and Alexa.

Go to the BrilliantSmart section  
on page 4 for more info or visit:

[brilliantlighting.com.au](http://brilliantlighting.com.au)  
or [brilliantsmart.com.au](http://brilliantsmart.com.au)





**18W**  
1250lm

**IK08**

**4200K**  
COOL  
WHITE

**IP44**  
RATING

**3YR**  
WARRANTY

- Ideal for kitchens, hallways and high traffic areas
- Surface mounted LED ceiling light.
- Simple, round design.
- Provides a uniform light-output using SMD LED technology.
- IP44 water-resistant.
- Steel base with toughened acrylic diffuser.
- Microwave Sensor with adjustable settings.
- Lux level sensing (5lux, 30lux, 150lux, 2000lux).
- Detection range (2m, 5m, 8m).
- Timer setting (5sec, 30sec, 90sec, 3min, 5min, 10min).
- Detection: 360° x 8m, lux setting, time on: 5s to 10m.



MODEL NO.	WATT (W)	LUMENS (LM)	COLOUR
19650/05	18	1250	White

# ALLORA LED

## DIMMABLE CEILING LIGHT



**12W**  
**1200lm**

**18W**  
**1800lm**

**25W**  
**2400lm**

**4200K**  
**COOL  
WHITE**

  
**DIMMABLE**

**3YR**  
**WARRANTY**

- Surface mounted LED ceiling light.
- Slim, modern and stylish design.
- Provides a uniform light-output using SMD LED technology.
- Polycarbonate diffuser.
- Integrated dimmable driver.
- Indoor use only.

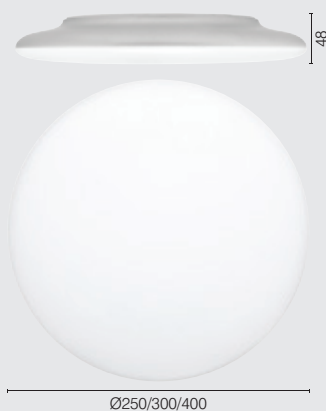

MODEL NO.	WATTAGE (W)	LUMENS (lm)	COLOUR
20093/11	12	1200	Silver
20094/11	18	1800	Silver
20095/11	25	2400	Silver

# CAPELLA CCT LED

CEILING LIGHT IP54

## TUNEABLE CCT

3000K — 6500K



18W

3000K  
4200K  
6500K

IP54  
RATING

3YR  
WARRANTY

- Switchable between 3000K, 4200K & 6500K via switch on back of light.
- IP54 Weather-resistant.
- Surface or wall mountable LED light.
- Modern, round design.
- Provides a uniform light-output using SMD LED technology.
- Polycarbonate diffuser.
- Silver front ring available separately.
- Integrated non-dimmable driver.
- Lifetime of 30,000 hours @ 40°C.



MODEL NO.	WATT (W)	LUMENS @ 3000K (lm)	LUMENS @ 4200K (lm)	LUMENS @ 6500K (lm)	COLOUR	DESCRIPTION
20096/05	18	1600	1700	1600	White	Surface Mount

# CORDIA CCT

COLOUR TEMPERATURE / CHANGING CEILING LIGHT

TUNEABLE CCT

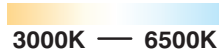

<b>12W</b> 950lm	<b>18W</b> 1350lm	<b>24W</b> 1750lm	<b>3000K</b> 4200K 6500K	<b>3YR</b> WARRANTY
---------------------	----------------------	----------------------	--------------------------------	------------------------

- Switchable between Warm White (3000K), Cool White (4200K) & Daylight (6500K) via switch inside light fitting.
- Surface mount LED ceiling light.
- Simple, round and unobtrusive design.
- Provides a uniform light-output using SMD LED technology.
- Toughened acrylic diffuser.
- Complete with integrated driver.
- Lifetime of 40,000 hours.



MODEL NO.	WATT (W)	LUMENS @ 3000K (lm)	LUMENS @ 4200K (lm)	LUMENS @ 6500K (lm)	COLOUR	SIZE
20460/05	12	850	950	900	White	Ø280mm x 80mm
20461/05	18	1250	1350	1300	White	Ø340mm x 90mm
20462/05	24	1600	1750	1680	White	Ø400mm x 95mm



12W

24W

3000K  
WARM  
WHITE

3YR  
WARRANTY

- Surface mounted LED ceiling light.
- Slim and modern ceiling fitting.
- Provides a uniform light-output using SMD LED technology.
- Toughened acrylic diffuser.
- Lifetime of 40,000 hours.



MODEL NO.	WATTAGE (W)	COLOUR TEMP (K)	LUMENS (lm)	COLOUR
19527/05	12	3000	750	White
19529/05	24	3000	1550	White

# OLSEN LED

## DIMMABLE SLIMLINE CEILING LIGHT



- Surface or wall mountable LED light.
- Modern, round design.
- IP54 Weather-resistant.
- Provides a uniform light-output using SMD LED technology.
- Acrylic diffuser with ABS front cover.
- Silver front face plate available separately.
- Integrated dimmable driver.
- Lifetime of 30,000 hours @ 25°C Ambient.



MODEL NO.	WATTAGE (W)	LUMENS (lm)	COLOUR
20084/05	25	2400	White





**42W  
MAX**

**DIY**

**1YR  
WARRANTY**

- Spherical Do-It-Yourself ceiling fittings with a gloss opal glass diffuser and brushed chrome fitting.
- Fits standard B22 batten holders typically installed in Australian homes.

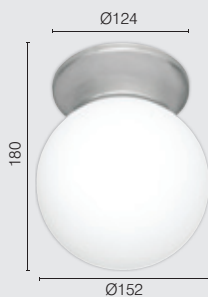

MODEL NO.	COLOUR
81000/13	Brushed Chrome

# SPIRELET

## CEILING LIGHT



- 30cm Classic ceiling fitting with alabaster style glass and decorative satin chrome clips.
- E27 60W max - globe not included.



MODEL NO.	COLOUR
17950/13	Brushed Chrome



**20W  
MAX**

100407/13

**2x20W  
MAX**

100408/13

**E27**

**1YR  
WARRANTY**

- Classic styled ceiling fittings with opal glass and chrome clips and metalware.
- To be installed by qualified electrician.
- E27 20W max - globes not included.



MODEL NO.	SIZE (CM)	COLOUR
100407/13	30	Brushed Chrome
100408/13	40	Brushed Chrome





**18W  
MAX**

**E27**  

**2YR  
WARRANTY**

- Simple, elegant angled design wall sconce with frosted glass diffuser.
- To be installed by electrician.
- Uses E27 18W max globe (not included).



MODEL NO.	FITTING COLOUR
18072/15	White/Chrome





# DOWNLIGHT

We have an extensive range of stylish and energy efficient downlights to suit any ceiling



# SMART DOWNLIGHT RANGE



**AMOUNT OF DEVICES IS LIMITED TO YOUR WIFI ROUTER**

**TRILOGY**  
SMART WIFI CCT LED DOWNLIGHT – 20695/05



**AMOUNT OF DEVICES IS LIMITED TO YOUR WIFI ROUTER**

**PRISM**  
SMART WIFI RGB+CCT LED DOWNLIGHT – 20716/05

 **WiFi**  
**NO HUB REQUIRED**

Have full control of your smart devices via the BrilliantSmart App, or via voice control with Google and Alexa.

Go to the BrilliantSmart section on page 6 for more info or visit:

[brilliantlighting.com.au](http://brilliantlighting.com.au)  
or [brilliantsmart.com.au](http://brilliantsmart.com.au)





## GIMBAL LED DOWNLIGHT



<b>3000K</b> WARM WHITE	<b>4000K</b> COOL WHITE	<b>40°</b> BEAM ANGLE	<b>DIMMABLE</b>	<b>70-93mm</b>	<b>97mm</b>	<b>5YR</b> WARRANTY
17678 17716 17717	17679			11W 13W	8W	

- COB LED for superior light output.
- High-grade aluminium construction with gimbal design and white powdercoated finish.
- Deep recessed design of light source, anti-glare light control, creating a comfortable light environment.
- Dimmable LED driver with 1.2m flex& plug.
- Long lasting, up to 35,000 hours<sup>1</sup>.
- CRI >80
- Power factor 0.82
- 8W rated 9W with driver,  
11W rated 14W with driver,  
13W rated 16W with driver

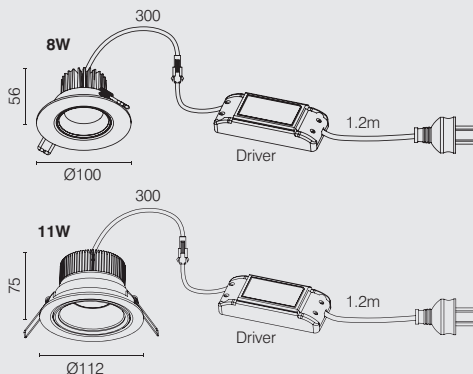

MODEL NO.	WATT (W)	LUMINOUS FLUX (lm)	COLOUR TEMP (K)	COLOUR
<b>17678/05</b>	8	650	3000	White
<b>17679/05</b>	8	700	4000	White
<b>17716/05</b>	11	750	3000	White

<sup>1</sup> At 40°C ambient temperature. Actual life may vary depending on individual circumstances.

# LUMASCAN

## COLOUR TEMPERATURE CHANGING LED DOWNLIGHT WITH SENSOR

### TUNEABLE CCT

3000K — 5000K



FRONT ONLY

- Switchable between Warm White (3000K), Cool White (4000K) & Natural White (5000K).
- Rated for IC-4/IC-F Abutted and Covered usage to allow for covering with thermal insulation.
- Fixed head downlight.
- Moulded polycarbonate body.
- Wide 100 degree beam angle.
- Integrated driver.
- 0.6mm flex & plug fitted.
- Terminals for hard wiring.
- Detection: 360° x 4m, lux sensor, time on: 1 min.

### SENSOR

PIR Motion sensor

Detection Range: 4m

Detection Angle: 360 degrees

Duration Time: 1 minute, subsequent detection will restart the minute timer.

DAYLIGHT SENSOR ENSURES THAT DETECTION ONLY OCCURS WITH LOW AMBIENT LIGHT

### APPLICATIONS

All interior residential rooms.

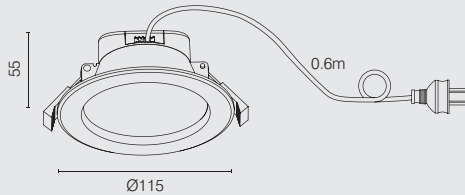

MODEL NO.	WATTAGE (W)	LUMENS @ 3000K(lm)	LUMENS @ 4000K (lm)	LUMENS @ 5000K (lm)
20214/05	9	760	840	760



# LUXOR CCT

## COLOUR TEMPERATURE CHANGING GIMBAL DOWNLIGHT

TUNEABLE CCT

3000K — 6500K



FRONT ONLY

- CCT Switchable between Warm White (3000K), Cool White (4200K) & Daylight (6500K).
- Rated for ICF/IC-4 Abutted and Covered usage to allow for covering with thermal insulation.
- Gimbal head downlight 22°
- Diecast aluminium construction.
- White powder coated finish.
- COB LED technology for superior light output.
- External dimmable LED driver.
- Flex & plug (Total length 1m).
- Long lasting up to 30,000 hours<sup>1</sup>.
- Cut-out 70-93mm.

### APPLICATIONS

All interior residential rooms.

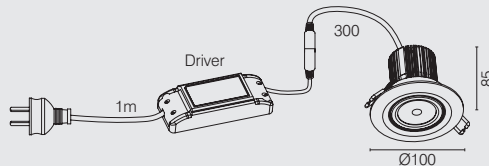

MODEL NO.	WATT (W)	LUMENS @ 3000K(lm)	LUMENS @ 4200K(lm)	LUMENS @ 6500K(lm)	COLOUR
20203/05	10	800	900	880	White

<sup>1</sup> At 40°C ambient temperature. Actual life may vary depending on individual circumstances.

# MINI TRIM II

## COLOUR TEMPERATURE CHANGING GIMBAL DOWNLIGHT

### TUNEABLE CCT

3000K — 6500K



- CCT Switchable between Warm White (3000K), Cool White (4200K) & Daylight (6500K).
- Rated for IC-F/IC-4 abutted and covered usage to allow for covering with thermal insulation.
- Gimbal head downlight.
- Diecast aluminium construction.
- White or black powder coated finish.
- COB LED technology for superior light output.
- External dimmable LED driver.
- Flex & plug (Total length 1.0m).
- Long lasting up to 30,000 hours<sup>1</sup>.
- Cut-out 90mm.

### APPLICATIONS

All interior residential rooms.

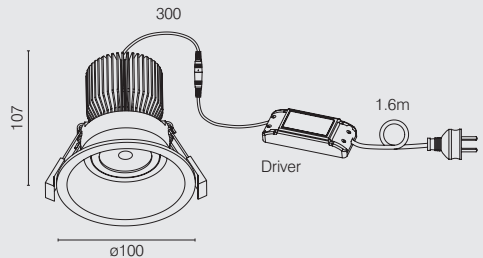

MODEL NO.	WATT (W)	LUMENS @ 3000K (lm)	LUMENS @ 4200K (lm)	LUMENS @ 6500K (lm)	COLOUR
20454/05	10	750	860	880	White
20454/06	10	700	800	820	Black

<sup>1</sup> At 40°C ambient temperature. Actual life may vary depending on individual circumstances.

# QUATTRO

## LED DOWNLIGHT WITH FOUR INTERCHANGEABLE TRIMS

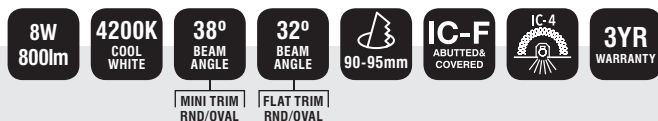

- 4 configurations in 1.
- Rated for IC-F/IC-4 Abutted and covered usage to allow for covering with thermal insulation.
- Gimbal head downlight.
- Diecast aluminium trims and heatsink.
- Includes 4 trims (2 x round & 2 x oval).
- Multiple beam angles depending on engine position and trim.
- High efficiency LED SMD Array.
- External dimmable LED driver.
- Long lasting up to 30,000 hours<sup>1</sup>.
- 1m flex & plug fitted.

### APPLICATIONS

All interior residential rooms.

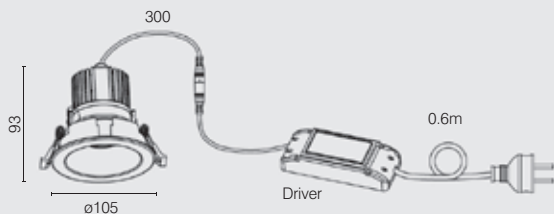

MODEL NO.	WATTAGE (W)	LUMENS MINI TRIM (RND/OVAL) (lm)	LUMENS FLAT TRIM (RND/OVAL) (lm)	COLOUR
19909/05	8	780	820	White

<sup>1</sup> At 40°C ambient temperature. Actual life may vary depending on individual circumstances.

## LARGE COLOUR TEMPERATURE CHANGING LED DOWNLIGHT

TUNEABLE CCT

3000K — 6500K



- Change between Warm White (3000K), Cool White (4200K) & Daylight (6500K) via a switch on the back of the downlight.
- Rated for IC-F/IC-4 abutted and covered usage to allow for covering with thermal insulation.
- Wide 100 degree beam angle.
- SAA approved with external dimmable LED driver.
- Long lasting up to 30,000 hours<sup>1</sup>.
- 1m flex & plug fitted.
- IP44 (front only).
- Four common cut-out sizes to suit most retrofit applications.

### APPLICATIONS

All interior domestic and commercial rooms.

VEET: 7054

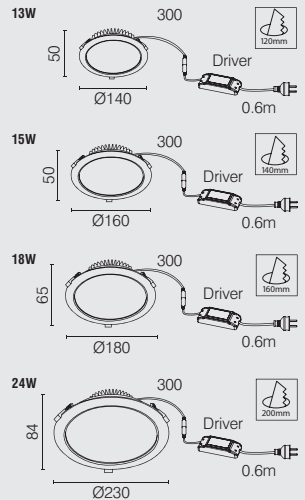

MODEL NO.	WATTAGE (W)	LUMENS @ 3000K (LM)	LUMENS @ 4200K (LM)	LUMENS @ 6500K (LM)	CUT-OUT (MM)	COLOUR
19761/05	13	820	920	820	120	White
19762/05	15	1150	1300	1150	140	White
19763/05	18	1300	1500	1300	160	White
19764/05	24	1800	2000	1800	200	White

<sup>1</sup> At 40°C ambient temperature. Actual life may vary depending on individual circumstances.

# THE DUET

## COMBINATION RECESSED OR SURFACE MOUNT CCT DOWNLIGHT

### TUNEABLE CCT

3000K — 6000K

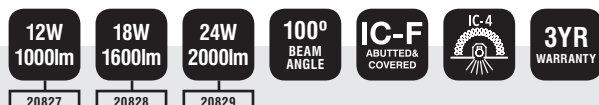
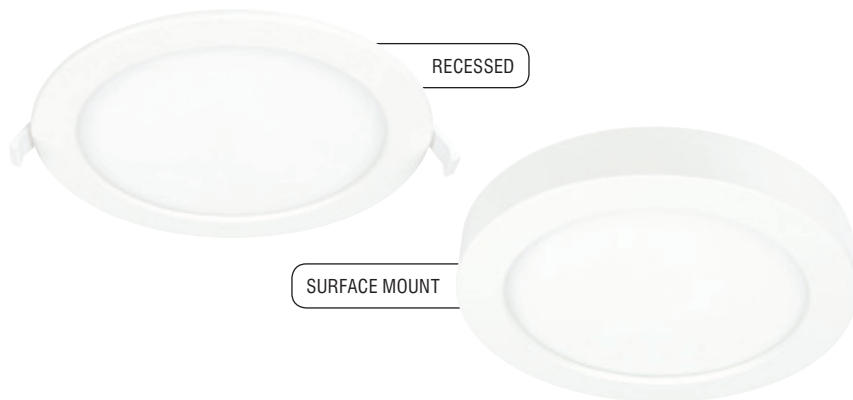

- Warm White (3000K), Cool White (4000K) & Daylight (6000K) via a switch.
- Rated for IC-F Abutted and Covered usage.
- Wide 100 degree beam angle.
- Super slim SAA approved internal non-dimmable LED driver.
- Long lasting up to 30,000 hours<sup>1</sup>.
- 0.6m flex & plug fitted.
- 3 x cut-out sizes to suit most Retrofit applications.
- Includes all fittings to convert to either recessed or surface mount.

### APPLICATIONS

All interior domestic and commercial rooms, shops, hotels and offices.

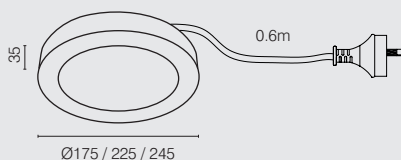
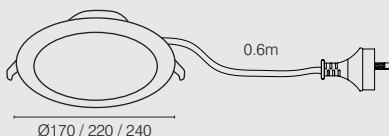

MODEL NO.	WATTAGE (W)	LUMENS @ 3000K (LM)	LUMENS @ 4200K (LM)	LUMENS @ 6000K (LM)	CUT-OUT (MM)	COLOUR
20827/05	12	800	1000	900	145	White
20828/05	18	1400	1600	1600	195	White
20829/05	24	1600	2000	1800	215	White





**4000K**  
COOL  
WHITE

**DIMMABLE**

**10W**  
770lm

**90mm**

**IC-F**  
ABTITTED&  
COVERED

**IC-4**

**5YR**  
WARRANTY

- Round design with glass surround.
- 4000K Cool White.
- Input: 200/240VAC 50/60Hz.
- Output: 21/42VDC, 280mA 10W
- Dimmable LED driver with 0.6m flex & plug.
- 10W rated (with driver).

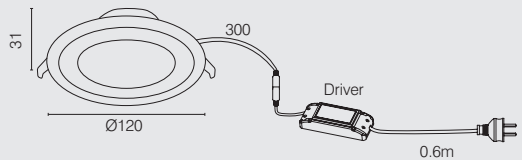

MODEL NO.	WATTAGE (W)	LUMENS (lm)	COLOUR TEMP (K)	COLOUR
20757/05	10	770	4000	White

# TRILOGY

## COLOUR TEMPERATURE CHANGING DOWNLIGHT

### TUNEABLE CCT

3000K — 5000K



FRONT ONLY

- Switchable between Warm White (3000K), Cool White (4000K) & Natural White (5000K).
- Rated for IC-F/IC-4 Abutted and Covered usage to allow for covering with thermal insulation.
- Fixed head downlight.
- Moulded plastic body.
- Wide 100 degree beam angle.
- High efficiency SMD LED Array.
- Integrated dimmable LED driver.
- Long lasting up to 30,000 hours<sup>1</sup>.
- 0.6m flex & plug plus terminals for hardwiring.
- IP44 (front only).

### APPLICATIONS

All interior residential rooms.

**VEET: 7102**

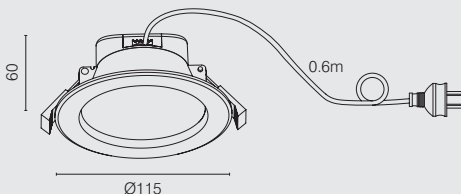

MODEL NO.	WATTAGE (W)	LUMENS @ 3000K (lm)	LUMENS @ 4000K (lm)	LUMENS @ 5000K (lm)	COLOUR
20429/05	8	780	900	880	White

<sup>1</sup> At 40°C ambient temperature. Actual life may vary depending on individual circumstances.

# UMBRA CCT

## COLOUR TEMPERATURE CHANGING DOWNLIGHT

### TUNEABLE CCT

3000K — 6500K



FRONT ONLY

- CCT Switchable between Warm White (3000K), Cool White (4200K) & Daylight (6500K).
- Rated for IC-4 Abutted and Covered usage to allow for covering with thermal insulation.
- Fixed head downlight.
- Diecast aluminium construction.
- White powder coated finish.
- High efficiency LED SMD Array.
- External dimmable LED driver.
- Flex & plug (Total length 0.6m).
- Long lasting up to 30,000 hours<sup>1</sup>.
- IP44 (front only).

### APPLICATIONS

All interior residential rooms.

VEET: 7178

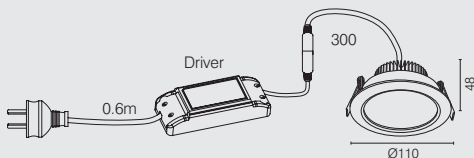

MODEL NO.	WATTAGE (W)	LUMENS @ 3000K (lm)	LUMENS @ 4200K (lm)	LUMENS @ 6500K (lm)	COLOUR
20204/05	10	820	900	860	White

<sup>1</sup> At 40°C ambient temperature. Actual life may vary depending on individual circumstances.





# LED STRIP LIGHTING

An easy and effective way to  
illuminate and accent any area

# LED STRIP LIGHT KIT

## 2.4M MODULAR



- 2.4m LED Strip
  - 3 x 60cm
  - 2 x 30cm
  - 3 x Corner Joiners
  - 2 x T Joiners
  - 8 x 4-Pin Connectors.
- Extra low voltage 12V driver
- 1.8m of cable with an inline switch.
- 60 LEDs per metre.
- Extra low voltage driver included with flex & plug.
- Pre-fitted with 3M™ self adhesive tape.
- Inline switch.
- Can cut every 5cm or every 3 LEDs.
- Available in Warm White or Cool White.

### APPLICATIONS

All interior residential rooms

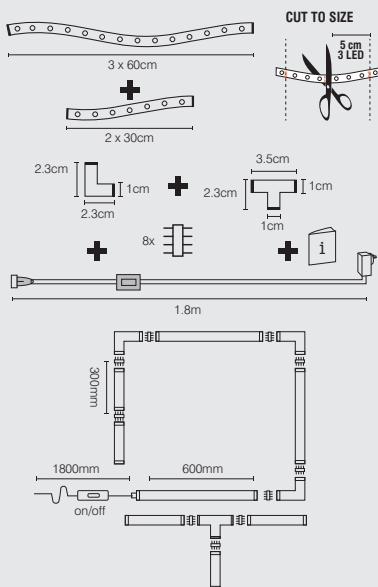

MODEL NO.	LENGTH (m)	WATTS PER METRE (W/m)	LUMENS PER METRE (lm/m)	STRIP ONLY IP RATING	COLOUR
17558/01	2.4	5	400	IP65	Warm White
17559/01	2.4	5	430	IP65	Cool White

# LED STRIP LIGHT KIT

RGB + WHITE DIY 2.4M MODULAR KITS

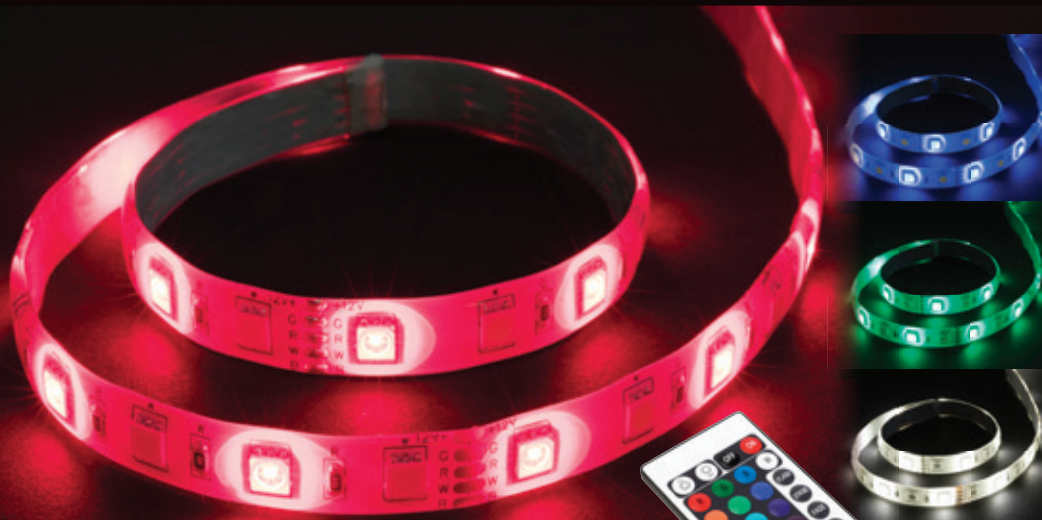

STRIP ONLY

- RGB colours + White 4200K LED Strip Kit.
- 2.4m LED Strip.
- 3 x 60cm.
- 2 x 30cm.
- 3 x Corner Joiners.
- 2 x T Joiners.
- 8 x 5-Pin Connectors.
- 60 LEDs per metre.
- Extra low voltage driver included with flex & plug.
- 1.8m of cable with an inline switch.
- RGB controller & IR remote.
- Pre-fitted with 3M™ self adhesive tape.
- Inline switch.
- Can cut every 10cm or every 6 LEDs.

## APPLICATIONS

All interior residential rooms.

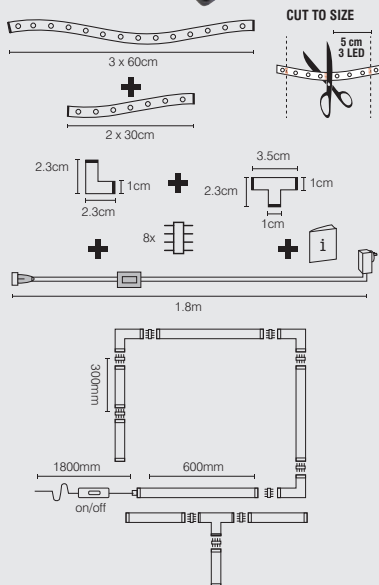

MODEL NO.	LENGTH (M)	WATTS PER METRE(W/m)	DIMMABLE	LUMENS PER METRE (lm/m)	MAX LUMEN(lm)	IP RATING STRIP ONLY	OPERATING MODES	COLOUR COMBINATIONS RGB + WHITE
20115	2.4	6	YES	400	930	IP65	5	16

# LED STRIP LIGHT KIT

5M & 10M ROLLS

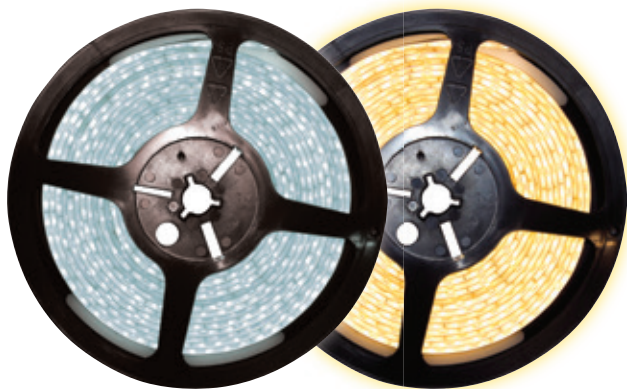

<b>12V</b>	<b>24V</b>	<b>DIY</b>	<b>IP65 RATING</b>	<b>1YR WARRANTY</b>
5M ROLL	10M ROLL		STRIP ONLY	

- Do-It-Yourself Installation.
- 60 LEDs per metre.
- Extra low voltage driver included with flex & plug.
- Pre-fitted with 3M™ self adhesive tape.
- 5m LED strip with extra low voltage 12V driver.
- 10m LED strip with extra low voltage 24V driver.
- 1.8m of cable with an inline switch.
- Can cut every 5cm or every 3 LEDs.
- Available in Warm White or Cool White.
- Comes in 5m or 10m Rolls.
- Supplied with 4 link cables.

## APPLICATIONS

All interior residential rooms.

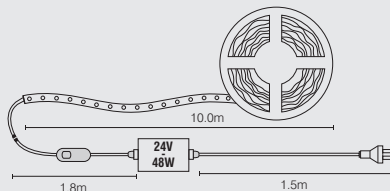
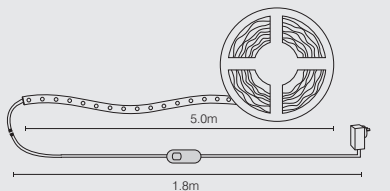
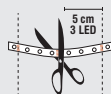

MODEL NO.	LENGTH (m)	WATTS PER METRE (W/m)	LUMENS PER METRE (lm/m)	STRIP ONLY IP RATING	COLOUR
17879	5	4.5	320	IP65	Warm White
17880	5	4.5	340	IP65	Cool White
19530	10	4.5	350	IP65	Warm White
19531	10	4.5	400	IP65	Cool White



# LED STRIP LIGHT KIT

RGB + WHITE DIY 5M & 10M ROLLS



- 12V DC**
- DIMMABLE**
- DIY**
- IP65 RATING**
- 1YR WARRANTY**

STRIP ONLY

- RGB colours + White 4200K.
- Do-It-Yourself Installation.
- 36 LEDs per metre.
- Extra low voltage driver included with flex & plug.
- Pre-fitted with 3M™ self adhesive tape.
- Inline switch.
- Can cut every 16.8cm or every 6 LEDs.
- Comes in 5m or 10m Rolls.
- 1.8m of cable.
- Supplied with 4 link cables
- Includes Infra-red remote control.

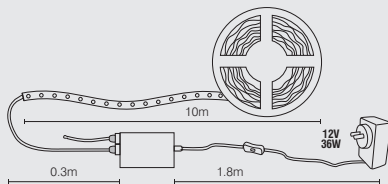
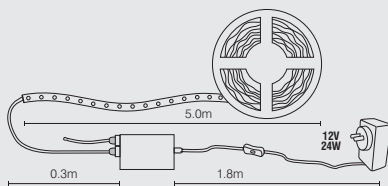

## APPLICATIONS

All interior residential rooms.



MODELNO.	LENGTH(M)	WATTS PER METRE(W/m)	DIMMABLE	LUMENS PER METRE (lm/m)	MAX LUMEN(lm)	IP RATING STRIP ONLY	OPERATING MODES	COLOUR COMBINATIONS RGB + WHITE
20111	5	2.6	YES	210	1000	IP65	5	16
20114	10	1.7	YES	135	1400	IP65	5	16



KEEP THIS  
DOOR  
SHUT  
ALWAYS  
PLS

WELCOME TO  
OUR CAFE  
PLEASE ENJOY  
YOUR VISIT  
AND THANK YOU  
FOR CHOOSING  
US



# GLOBES

Brilliant have an extensive range of globes for domestic, business, commercial and decorative uses



# SMART GLOBE RANGE



**A60 SMART WIFI CCT LED GLOBE**  
E27 & B22 – 20696/05, 20697/05



**A60 SMART WIFI RGBW LED GLOBE**  
E27 & B22 – 20698/05, 20699/05



**GU10 SMART WIFI CCT LED GLOBE**  
21468



**GU10 SMART WIFI RGBW LED GLOBE**  
21469

 **WiFi**  
**NO HUB  
REQUIRED**

Have full control of your smart devices  
via the BrilliantSmart App, or via  
voice control with Google and Alexa.

Go to the BrilliantSmart section  
on page 4 for more info or visit:

[brilliantlighting.com.au](http://brilliantlighting.com.au)  
or [brilliantsmart.com.au](http://brilliantsmart.com.au)





Wyatt suspension kit shown with globes.



- Gentle mood and warm ambience to any space.
- Opal finish.
- Non-dimmable and long-lasting.
- Lifespan: Up to 10,000 hours<sup>†</sup>.

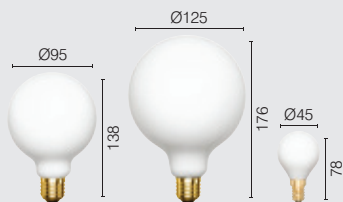

MODEL NO.	STYLE	WATTAGE (W)	LUMENS (LM)	BASE	SIZE
20333	G95 BALL	4W	300	E27 SCREW	Ø95 x 138mm
20334		4W	300	B22 BAYONET	
20239		5W	360	E27 SCREW	
20335	G125 BALL	4W	300	E27 SCREW	Ø125 x 176mm
20336		4W	300	B22 BAYONET	
20240		5W	360	E27 SCREW	
20332	G45 BALL	4W	280	E14 SCREW	Ø45 x 78mm
20241		5W	320	E14 SCREW	

<sup>†</sup> Actual life may vary depending on individual circumstances.

# COSMOS

## MAXI AMBER COATED FLEXIBLE FILAMENTLED GLOBES



Andy suspension kit shown with globes.



- Add some interest and atmosphere to your home.
- Dimmable and long-lasting.
- Lifespan: Up to 10,000 hours<sup>†</sup>.

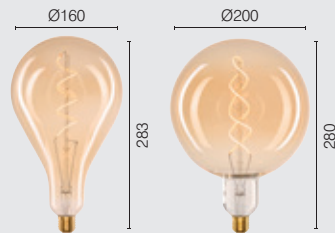

MODEL NO.	STYLE	WATTAGE (W)	LUMENS (LM)	BASE	SIZE	DIMMABLE
20297	PS160	4W	280	E27 SCREW	Ø160 x 283mm	Yes
20298	G200	4W	280	E27 SCREW	Ø200 x 280mm	Yes

<sup>†</sup> Actual life may vary depending on individual circumstances.



# LED CAPSULES

## G9 & G4 GLOBE TWIN PACKS / + SINGLES



**240V**  
50Hz

**12V**  
AC/DC

G9

G4

- G9 3W LED Lamp is commonly used in chandeliers and pendant lights, downlights, wall lights, security lighting and under cabinet downlights.
- G4 3.5W LED Lamp is commonly used in downlights, cookers, rangehoods, motorhomes, boats and caravans.
- Direct replacement for halogen G9 and G4 capsules.
- No UV, no mercury or IR radiation.
- UV radiation free.
- G9 Lifespan: Up to 8,000 hours<sup>†</sup>.
- G4 Lifespan: Up to 5,000 hours<sup>†</sup>.

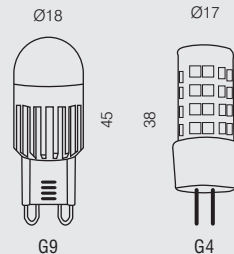

MODEL NO.	WATTAGE (W)	LUMENS (LM)	COLOUR TEMP	BASE	DIMMABLE	SIZE
18552	3	200	3000K Warm White	G9 BI-PIN	No	Ø18.2 x 45mm
18862	3.5	330	2700K Warm White	G4 BI-PIN	No	Ø17.5 x 38mm
19096	3	200	3000K Warm White	G9 BI-PIN	No	Ø18.2 x 45mm
19098	2	180	2700K Warm White	G4 BI-PIN	No	Ø15 x 29mm

<sup>†</sup> Actual life may vary depending on individual circumstances.



# LED CANDLE 4W

## CANDLE SHAPED GLOBE



- Decorative lighting purposes.
- High-powered SMD array technology.
- Brilliant Candle LED globes last up to 15,000 hours.<sup>†</sup>

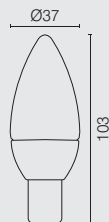

MODEL NO.	WATTAGE (W)	LUMENS (LM)	COLOUR TEMP	BASE	DIMMABLE	SIZE
<b>18545</b>	4	250	3000K Warm White	E14 Small Screw	No	Ø37 x 103mm
<b>18546</b>	4	250	3000K Warm White	B22 Bayonet	No	Ø37 x 103mm
<b>18547</b>	4	250	3000K Warm White	E27 Screw	No	Ø37 x 103mm

\* Replacement wattages and lumens are approximates and are to be used as a guide only.

<sup>†</sup> Actual life may vary depending on individual circumstances.

# LED CLASSIC

## A60 SHAPED NON-DIMMABLE GLOBE



**240°**  
BEAM  
ANGLE

**CRI**  
> 80

**3000K**  
WARM  
WHITE

**4200K**  
COOL  
WHITE

**6500K**  
DAY  
LIGHT

- Perfect LED retro-fit solution to incandescent, halogen or compact fluorescent A60 shaped globes.
- High-powered SMD array technology.
- Features a high impact resistance for greater durability.
- Brilliant Classic A60 LED globes last up to 20,000 hours.<sup>†</sup>

MODEL NO.	WATTAGE (W)	LUMENS (LM)	COLOUR TEMP	BASE	DIMMABLE	SIZE
19854	5W	450	3000K Warm White	E27 Screw	No	Ø60 x 110mm
20356	7W	600	3000K Warm White	E27 Screw	No	Ø60 x 110mm
20357	7W	600	3000K Warm White	B22 Bayonet	No	Ø60 x 110mm
19857	7W	620	4200K Cool White	E27 Screw	No	Ø60 x 110mm
19858	7W	620	4200K Cool White	B22 Bayonet	No	Ø60 x 110mm
20360	9W	820	3000K Warm White	E27 Screw	No	Ø60 x 110mm
20361	9W	820	3000K Warm White	B22 Bayonet	No	Ø60 x 110mm
19862	9W	840	4200K Cool White	B22 Bayonet	No	Ø60 x 110mm
19863	9W	860	6500K Daylight	E27 Screw	No	Ø60 x 110mm
20365	12W	1200	3000K Warm White	E27 Screw	No	Ø60 x 119mm
20366	12W	1200	3000K Warm White	B22 Bayonet	No	Ø60 x 119mm
19866	12W	1220	4200K Cool White	E27 Screw	No	Ø60 x 119mm
19867	12W	1220	4200K Cool White	B22 Bayonet	No	Ø60 x 119mm
19868	12W	1250	6500K DAYLIGHT	E27 Screw	No	Ø60 x 119mm

<sup>†</sup> Actual life may vary depending on individual circumstances.

# LED CLASSIC

## A60 SHAPED DIMMABLE GLOBE



- Perfect LED retro-fit solution to incandescent, halogen or compact fluorescent A60 shaped globes.
- High-powered SMD array technology.
- Features a high impact resistance for greater durability.
- Brilliant Classic A60 LED globes last up to 20,000 hours.<sup>†</sup>

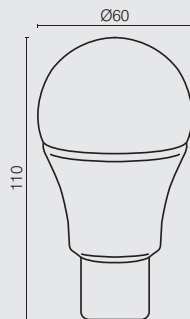

MODEL NO.	WATTAGE (W)	LUMENS (LM)	COLOUR TEMP	BASE	DIMMABLE	SIZE
19871	9W	860	4200K Cool White	E27 Screw	Yes <sup>2</sup>	Ø60 x 110mm
19872	9W	860	4200K Cool White	B22 Bayonet	Yes <sup>2</sup>	Ø60 x 110mm

<sup>†</sup> Actual life may vary depending on individual circumstances.

<sup>2</sup> Compatibility may vary depending on dimmer used.

# LED CLASSIC 4 PACK

## A60 SHAPED NON-DIMMABLE GLOBE



7W

9W

265°  
BEAM  
ANGLE

CRI  
> 80

3000K  
WARM  
WHITE

- 7W/600 lumens or 9W/820 lumens.
- Convenient 4 pack.
- Colour temperature 3000K warm white.
- 265° beam angle.
- UV safe.
- High grade plastic construction.
- Up to 20,000 hour lifetime<sup>†</sup>
- Non-dimmable.

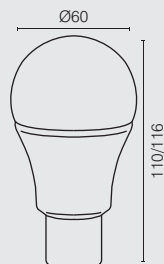

MODEL NO.	WATTAGE (W)	LUMENS (LM)	COLOUR TEMP	BASE	DIMMABLE	SIZE
20480	7W	600	3000K WARM WHITE	E27 SCREW	No	Ø60 x 110mm
20481	7W	600	3000K WARM WHITE	B22 BAYONET	No	Ø60 x 110mm
20482	9W	820	3000K WARM WHITE	E27 SCREW	No	Ø60 x 116mm
20483	9W	820	3000K WARM WHITE	B22 BAYONET	No	Ø60 x 116mm

<sup>†</sup> Actual life may vary depending on individual circumstances.

# LED FANCY ROUND 3W

FANCY ROUND SHAPED GLOBE



- Decorative and general-purpose lighting.
- Fancy Round Frosted LED globes are great for mood or ambient lighting.
- High-powered SMD array technology.
- Brilliant Fancy Round LED globes last up to 15,000 hours\*.

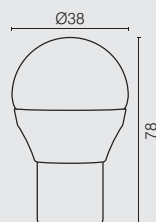

MODEL NO.	WATTAGE (W)	LUMENS (LM)	COLOUR TEMP	BASE	DIMMABLE	SIZE
18880	3	250	3000K Warm White	B15 Small Bayonet	No	Ø38 x 78mm
18550	3	250	3000K Warm White	E27 Screw	No	Ø38 x 78mm

\* Actual life may vary depending on individual circumstances.

# ANTI INSECT

## COMPACT FLUORESCENT GLOBE



**20W**

- 20W max E27 and B22 globe.
- Yellow spiral design.
- Keeps bugs away.
- Lifespan: Up to 6000 hours<sup>†</sup>.



MODEL NO.	BASE
<b>19185</b>	E27
<b>19186</b>	B22

<sup>†</sup> Actual life may vary depending on individual circumstances.

# LED ANTI-INSECT

## A60 SHAPED NON-DIMMABLE GLOBE



9W

- 600 lumens.
- Lifespan: Up to 15,000 hours†.
- Less attractive to insects.
- 240 Volt, 50Hz.



MODEL NO.	WATTAGE (W)	LUMENS (LM)	BASE	DIMMABLE	SIZE
20524	9	600	E27	No	Ø60 x 110mm
20525	9	600	B22	No	Ø60 x 110mm

† Actual life may vary depending on individual circumstances.

# LED PAR38

## COLOURED REFLECTOR GLOBE



- Hard glass construction.
- Prismatic diffuser.
- Non-dimmable.
- Lasts up to 20,000 hours<sup>†</sup>.
- IP65 weather-resistant rating<sup>^</sup>.
- Suitable for most PAR38 fixtures.
- Coloured glass diffuser helps keep bugs away.

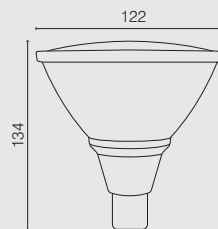

MODEL NO.	WATTAGE (W)	LUMENS (LM)	COLOUR	BASE	DIMMABLE	CRI (RA)	SIZE
19705/01	15W	150	Red	E27 SCREW	No	≤51	Ø122 x 134mm
19705/02	15W	1050	Yellow	E27 SCREW	No	≤59	Ø122 x 134mm
19705/03	15W	60	Blue	E27 SCREW	No	≤10	Ø122 x 134mm
19705/04	15W	250	Green	E27 SCREW	No	≤12	Ø122 x 134mm

<sup>†</sup> Actual life may vary depending on individual circumstances.

<sup>^</sup> To achieve this rating the fitting must seal the lamp clamp.



# LED PAR38

## REFLECTOR GLOBE



**IP66**  
RATING

**100°**  
BEAM  
ANGLE

**CRI**  
**>83**

- PAR38 replacements that look and light the way consumers expect.
- 10W version is made from high grade UV stabilised plastic with an opaque polycarbonate diffuser and lasts up to 30,000 hours<sup>†</sup>.
- 13W utilises the same textured hard glass of traditional halogen PAR38 globes and lasts up to 20,000 hours<sup>†</sup>.
- Suitable for use outdoors with their IP66 weather-resistant rating.

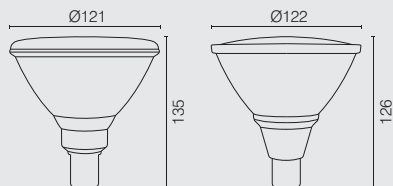

MODEL NO.	WATTAGE (W)	LUMENS (LM)	COLOUR TEMP	BASE	DIMMABLE	SIZE
<b>19408</b>	10	850	4200K Cool White	E27 Screw	No	Ø121 x 135mm
<b>18486</b>	13	1050	4000K Cool White	E27 Screw	No	Ø122 x 126mm

<sup>†</sup> Actual life may vary depending on individual circumstances.

# LED MR16/GU10

4W & 5W GLOBE



**60°**  
BEAM  
ANGLE

**CRI**  
**> 80**

- Brilliant's MR16 & GU10 LED Globes are cost efficient and energy saving.
- Output of 300 to 400 lumens.
- 60 degree beam spread.
- Available in warm white or cool white.
- With an average life of 10,000 hours, they are long lasting and save you money.

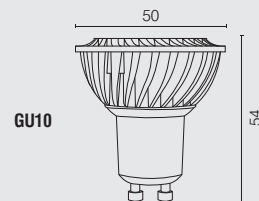
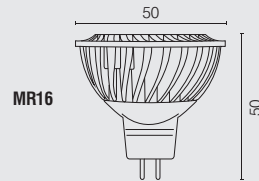

MODEL NO.	WATTAGE (W)	LUMENS (LM)	COLOUR TEMP	BASE	DIMMABLE	SIZE
20963	4	300	3000K Warm White	GU10	No	Ø50 x 54mm
20964	4	300	4000K Cool White	GU10	No	Ø50 x 54mm
20965	5	400	3000K Warm White	MR16	No	Ø50 x 50mm
20966	5	400	4000K Cool White	MR16	No	Ø50 x 50mm

<sup>†</sup> Actual life may vary depending on individual circumstances.

# LED R80

## REFLECTOR GLOBE



**100°**  
BEAM  
ANGLE

**CRI**  
>83

- Replacements for incandescent/halogen/CFL R63 & R80 lamps.
- Utilises the same shape as traditional bulbs.
- Wide diffused beam angle.
- Lasts up to 25,000 hours<sup>†</sup>.

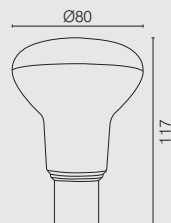

STYLE	MODEL NO.	WATTAGE (W)	LUMENS (LM)	COLOUR TEMP	BASE	DIMMABLE	SIZE
R80	20403	9	850	4200K Cool White	E27 Screw	No	Ø80 x 117mm

<sup>†</sup> Actual life may vary depending on individual circumstances.

# LED T8 TUBE

ACRYLIC

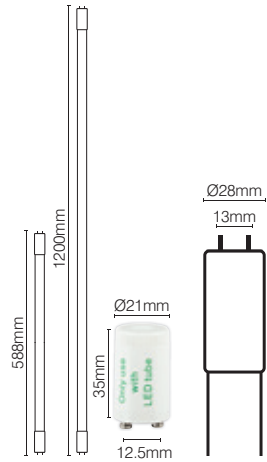

**CRI**  
**> 84**

**UV**  
**SAFE**

- Ideal retrofit solution for traditional T8 fluorescent lamps.
- Features an acrylic diffuser, making it safe for use in commercial kitchens.
- Lifespan: Up to 20,000 hours<sup>†</sup>.

APPROVALS (18W only)

VEET (ESC) 3904

MODEL NO.	WATTAGE (W)	LUMENS (LM)	COLOUR TEMP	BASE	DIMMABLE	STARTER LINK SUPPLIED	SIZE
<b>19273</b>	9	900	6500K Daylight	G13	No	Yes	Ø28 x 600mm
<b>18533</b>	18	1690	4200K Cool White	G13	No	Yes	Ø28 x 1200mm
<b>18534</b>	18	1750	6500K Daylight	G13	No	Yes	Ø28 x 1200mm

<sup>†</sup> Actual life may vary depending on individual circumstances.  
Please note: Only suitable with iron-core magnetic ballast. DO NOT USE with electronic ballast.  
Ensure conventional starter is removed and replaced with LED starter link, supplied in box.



**275W**

- Commonly used in bathroom heaters and in restaurants in food warmers.
- E27 (standard edison screw) 240V base.
- Instant Heat and start-up.
- Clear glass finish.
- R125 reflector globe.
- Anti-blast hard glass for durability.
- Lifespan: Up to 5000 hours<sup>†</sup>.



MODEL NO.	BASE
18782	E27

Bathroom Mate used for illustrative purposes only.

<sup>†</sup> Actual life may vary depending on individual circumstances.

# MOON BEAM

## LED FILAMENT ANTIQUE STYLE GLOBE



Suspension kits for illustrative purposes only.

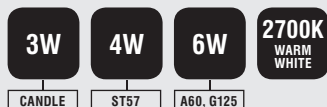

- Suitable for a multi-globe pendant light, as well as discreet lighting.
- New form LED (Light-emitting diode) with modern high efficiency LED technology.

**A60** Shaped like a classic globe and fits regular light fittings with 6 pieces of 37.5mm filament LED.

**G125** Shaped like a traditional round globe and fits regular light fittings with 4 pieces of 41mm filament LED.

**CANDLE** Shaped like a classic candle globe and fits small screw light fittings with 2 pieces of 37.5mm filament LED.

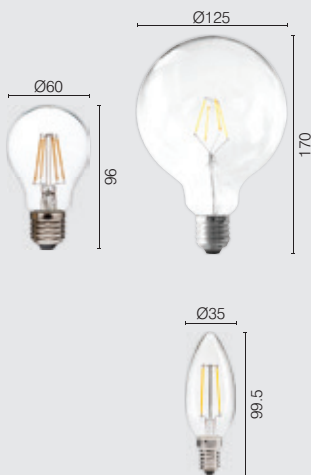

STYLE	MODEL NO. (BASE)			LUMENS (LM)
	E14	B22	E27	
A60	-	18612	18614	600
G125	-	-	18618	600
Candle	18616	-	-	300

# STAR GLOW

## LED ANTIQUE STYLE GLOBE



Suspension kits for illustrative purposes only.

**3W**

**2400K**  
WARM  
WHITE

- Fantastic for atmospheric lighting, as well as discreet lighting.
- This new form LED (Light-emitting diode) with modern high efficiency LED technology.
- Lifespan: Up to 10,000 hours\*.

**A60** Shaped like a classic globe and fits regular light fittings with 30 individual LEDs.

**G95** Shaped like a traditional standard round and fits regular light fittings with 47 individual LEDs.

**ST57** Shaped like the original Edison globe and fits regular light fitting with 47 individual LEDs.



STYLE	MODEL NO. (BASE)		LUMENS (LM)
	B22	E27	
A60	18621	18622	115
G95	18623	18563	152
ST57	18625	18626	150

\* Actual life may vary depending on individual circumstances.

# VINTAGE FILAMENT

## ANTIQUE STYLE GLOBE



Suspension kits for illustrative purposes only.

25W

- Antique-style globes add a bright warm glow to any vintage or contemporary decor.
- Lifespan: Up to 1000 hours<sup>†</sup>.

**G125** These Edison inspired globes are a favourite with their glowing cage-shaped filament surrounding a central glass support.

**ST18** The circa 1912 design is a favourite with its glowing cage-shaped tungsten filament surrounding a central glass support, which burns three times brighter than its carbon filament precursors. A popular choice for exposed socket pendants, sconces and chandeliers.



STYLE	MODEL NO. (BASE)	
	B22	E27
G125	17927	-
ST18	17925	-

<sup>†</sup> Actual life may vary depending on individual circumstances



# VINTAGE SPIRAL

## ANTIQUÉ STYLE GLOBE



Jedd suspension kit shown with globes.

25W

- Create atmosphere rather than light the entire room.
- Perfect for creating an intimate pool of light.
- Spiral design provides an elegant and detailed look to any fixture.
- Lifespan: Up to 1000 hours<sup>†</sup>.

**G95:** Edison inspired globes are a fantastic designer feature bulb for large fittings where you can see the bulb. They will certainly add a special touch of interest to any room. Features an amber coating.

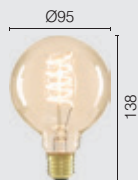

PRODUCT	MODEL NO. (BASE)	
	B22	E27
G95	19284	19286

<sup>†</sup> Actual life may vary depending on individual circumstances





# TABLE, TASK & FLOOR LAMPS

Create mood lighting with  
our stylish range of lamps

# AUGGIE

## MAGNIFIER LED LAMP



2.25 MAGNIFYING LENS  
DIOPTRÉ X5 MAGNIFYING



- Functional magnifying lamp. Ideal for reading and crafting.
- 2.25 Magnifying lens - dioptre x5 magnifying.
- Integrated LED.
- 4 Step dimmable.
- In-line switch.



MODEL NO.	TYPE	COLOUR
21425/05	Table	White



**12W  
MAX**



**6400K  
DAY  
LIGHT**

**1YR  
WARRANTY**

- All purpose magnifying lamp that is perfect for day to day use that features a powerful 90mm lens that offers a 3-diopter lens plus a 12-diopter lens for intricate activities.



MODEL NO.	TYPE	COLOUR
99201/55	Table	White

# SAMMY

## TASK & TABLE LAMP



- Retro style lamp, ideal for reading and working.
- Adjustable chrome neck
- Flexible neck.
- In-line switch
- Classic design
- Metal
- Uses E27 globe 28W max (globe not included)

### Brilliant recommends:



LED  
A60

Globes not included



MODEL NO.	TYPE	COLOUR
21414/03	Task	Matt Blue
21414/05	Task	Matt White
21414/06	Task	Matt Black
21414/08	Task	Matt Grey
21414/44	Task	Matt Pink



**28W  
MAX**

**E27**  

**2YR  
WARRANTY**

- Retro style clamp lamp, that can be placed anywhere. Ideal for reading, studying and working.
- Retro floor lamp, classic design, functional and ideal for the study or work station.
- Adjustable chrome neck
- In line switch
- Classic design
- Metal
- Uses E27 globe 28W max (globe not included)

### Brilliant recommends:



LED  
A60

Globes not included

MODEL NO.	TYPE	COLOUR
21419/05	Clamp	Matt White
21419/06	Clamp	Matt Black
21421/05	Floor	Matt White
21421/06	Floor	Matt Black









**7W**  
400lm

**4200K**  
COOL  
WHITE

**2YR**  
WARRANTY

- Desk task lamp, with a modern design.
- Functional and ideal for the study or work station.
- Three dimming modes
- Adjustable head

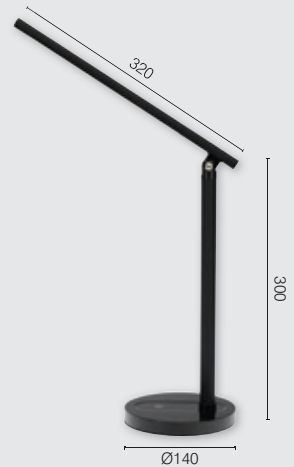

MODEL NO.	TYPE	COLOUR
21423/05	Task	White
21423/06	Task	Black

# PLUTO

## TASK & FLOOR LED LAMP



- Clean design with adjustable gooseneck to manoeuvre light where required.
- The floor lamp features 48 x SMD LED chips with an output of 300 lumens.



MODEL NO.	TYPE	COLOUR
18842/05	Floor	White

3x28W  
MAX

E14  

1YR  
WARRANTY

- Three light floor lamp in a matt finish.
- Great for use in a lounge room. Doubles for use as ambient or task lighting.



### Brilliant recommends:



Fancy Round  
LED



Fancy Round  
Halogen

Globes not included

MODEL NO.	TYPE	COLOUR
19604/06	Floor	Black



**28W  
MAX**

**E27**

**1YR  
WARRANTY**

- A unique interpretation of Retro revival.
- Inspired by the iconic 1947 silhouette of the grasshopper lamp. The Kyoto exaggerates these lines by mirroring the sharp angles of the tripod legs in the upper section.
- Finished with a rounded cut away shade. Coordinating black details have been used throughout to highlight integral junctions of this piece.

### Brilliant recommends:



Fancy Round  
LED



Fancy Round  
Halogen

Globes not included

MODEL NO.	TYPE	COLOUR
18991/06	Table	Black
18992/06	Floor	Black





**70W  
MAX**

**E27**  

**1YR  
WARRANTY**

- Sleek and stylish floor lamp in a brilliant chrome finish with an adjustable dome shade.

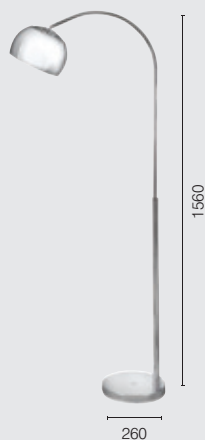

**Brilliant recommends:**



Silver  
Crown



LED  
A60



Halogen  
G95

Globes not included

MODEL NO.	TYPE	COLOUR
22074/15	Floor	Chrome

M T W  
6 7 8  
13 14 15  
20 21 22  
27 28

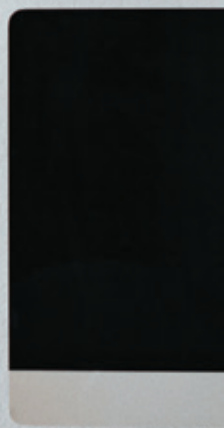



**28W  
MAX**

**E14**  

**1YR  
WARRANTY**

- Refined, industrial table lamps with clean lines and satin finishes.
- Slim line steel base, minimalist post and metalware simplify the industrial form.
- Matching pendants also available.

**Brilliant recommends:**



Fancy Round  
LED

Globes not included



MODEL NO.	TYPE	COLOUR
<b>18985/05</b>	Table	White
<b>18985/06</b>	Table	Black

# JACOBSON

## TABLE LAMP



- The unique stance of the Jacobsen legs are cut straight from the Modernist movement of the mid-century.
- Darkening the recently popular beech timber into a teak finish strengthens the lines of the classic stance. Topped with a matt metal shade. A strong, sharp finish that balances and frame the angular legs.
- The timber has a depth of grain. A bold and beautifully balanced occasional lamp.



### Brilliant recommends:



Fancy Round  
LED

Globes not included

MODEL NO.	TYPE	COLOUR
18979/06	Table	Black/Walnut





**42W  
MAX**

**E14**  

**1YR**  
WARRANTY

- The Pip glass table lamp is a cheerful and fun way to brighten your room.

### Brilliant recommends:



Fancy Round  
LED



LED Candle

Globes not included



MODEL NO.	TYPE	COLOUR
18953/02	Table	Yellow
18953/03	Table	Blue
18953/05	Table	White

# BRUNSWICK

## TABLE LAMP



28W  
MAX



1YR  
WARRANTY

- Inspired by vintage radio, constructed from timber, a waxed paper diffuser and features an adjustable timber handle.

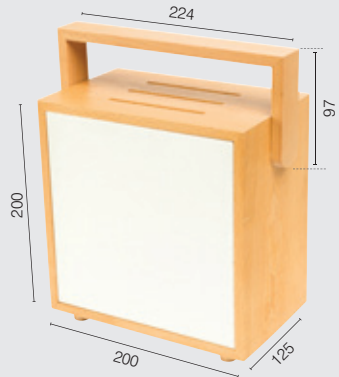

### Brilliant recommends:



Fancy Round  
LED



LED Candle

Globes not included

MODEL NO.	TYPE	COLOUR
19164/37	Table	Natural



**42W  
MAX**

**E27**  

**1YR  
WARRANTY**

- Sculpted, rounded glass shade echoes the pop art movement of the early 1950s, finished with a timber stand – perfectly balanced.
- The clear glass of the shapely, bold shade creates an inspiring mood and also presents as an opportunity to frame a decorative globe.

### Brilliant recommends:



Vintage  
ST57



Vintage  
G95



Star Glow  
G95

Globes not included



MODEL NO.	TYPE	COLOUR
18980/07	Table	Clear/Timber





# PENDANTS

Complete your look with classic  
and contemporary pendants

# DRAKE LED

## INDUSTRIAL STYLE PENDANT



**20W**  
900lm

**4200K**  
COOL  
WHITE

**DIY**  
PLUG-IN

**1YR**  
WARRANTY

- Industrial edge.
- high lumen output makes this pendant ideal for kitchens.
- Integrated LED.
- Plugs into existing B22 batten holders.



MODEL NO.	COLOUR
18138/05	White
18138/06	Black
18138/11	Silver



**42W  
MAX**

**E27**  

**1YR  
WARRANTY**

- High gloss finish.
- Uses E27 42W max globe (not included).

**Brilliant recommends:**



LED  
A60



Helix  
CFL

Globes not included

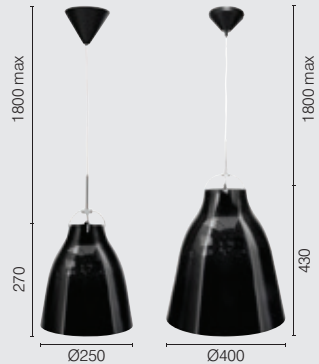

MODEL NO.	DIAMETER	COLOUR
<b>18675/05</b>	Ø250	Gloss White
<b>18675/06</b>	Ø250	Gloss Black
<b>18677/05</b>	Ø400	Gloss White
<b>18677/06</b>	Ø400	Gloss Black

# LISSER

## GLASS PENDANT





**42W  
MAX**

**E27**  

**1YR  
WARRANTY**

- Unique method of the suspension adds to the subtle elegance of this pendant.
- Clear glass or smoke.

**Brilliant recommends:**

		
Helix CFL	Star Glow LED	Vintage G125

Globes not included

MODEL NO.	COLOUR
18653/07	Clear







**60W  
MAX**

**E27**  

**1YR  
WARRANTY**

- Brilliant chrome finish with a red fabric sheathed cord.
- Adjustable to suit ceiling height variations.

**Brilliant recommends:**



Moonbeam  
ST57



Moonbeam  
ST57

Globes not included

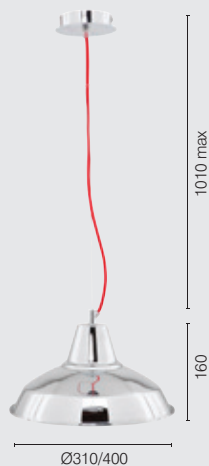

MODEL NO.	SIZE	COLOUR
<b>100376/15</b>	310mm	Chrome/Red
<b>100375/15</b>	400mm	Chrome/Red

# SYPHON

## 3 LIGHT PENDANT



3x28W  
MAX



1YR  
WARRANTY

- Slim line steel base, minimalist wire suspension and metalware simplify the industrial form.
- Coordinating table lamps available.

### Brilliant recommends:



Classic A60  
LED

Globes not included

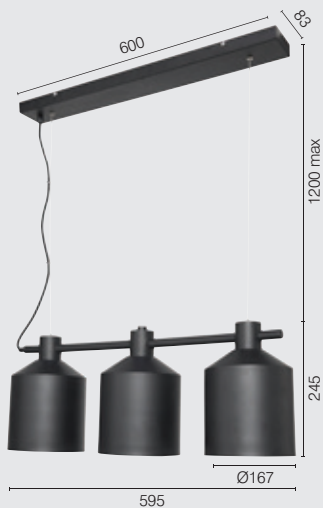

MODEL NO.	COLOUR
18989/05	White
18989/06	Black



Plastic



Metal

**60W  
MAX**

**B22**  

**DIY**  
PLUG-IN

- **Do-It-Yourself** pendant cord sets in white and black finishes.
- Plugs into existing B22 Batten holders.
- Max shade weight of 1.5kg can be attached.

MODEL NO.	COLOUR	DESCRIPTION	MAX CORD LENGTH
00120/05	White	Plastic canopy	690mm
11640/06	Black	Metal canopy	600mm



# Brilliant

## **Brilliant Lighting**

956 Stud Road  
Rowville VIC 3178 Australia

[www.brilliantlighting.com.au](http://www.brilliantlighting.com.au)

## **Australia Sales**

**T** 03 9765 2555

**T** 1800 817 754 (Interstate only)

**F** 03 9763 0277

**E** [sales@brilliantlighting.com.au](mailto:sales@brilliantlighting.com.au)

## **New Zealand Sales**

**T** 09 9749618

**E** [sales@brilliantlighting.co.nz](mailto:sales@brilliantlighting.co.nz)

[www.brilliantlighting.co.nz](http://www.brilliantlighting.co.nz)



[/BrilliantLighting](https://www.facebook.com/BrilliantLighting)



[/brilliant\\_au](https://www.instagram.com/brilliant_au)



[/brilliant-lighting](https://www.linkedin.com/company/brilliant-lighting)



[/brilliant\\_au](https://www.youtube.com/channel/UC...)