



WITH *you* IN MIND

—240V/50Hz—

*Hunter*  
SINCE 1886





50617 Nova



Fan featured on cover: Contempo 50612

EACH AND EVERY IMPROVEMENT MADE  
**WITH YOU IN MIND**

We're never satisfied. Our newest collection not only showcases all the innovative design, quality craftsmanship, and unmatched performance you expect from Hunter®; it also features a variety of improvements designed to give our customers better products, more flexibility, easier installation, and the best possible experience.



We stand behind the quality and craftsmanship of each and every fan with our Lifetime Limited Motor Warranty. Backed by the only fan company that's been around for over 125 years, it's a guarantee that you can trust.



With Hunter's new hanging system, installation is easier than ever. Our patented triangular hanger-ball system reduces torque for maximum stability and unmatched performance, and our improved owner's manual puts you in control.



Our latest universal controls come loaded with new innovative features: automatic pairing, secure programming to eliminate interference, and longer range (up to 23m). And they're damp rated for use on covered porches.

*Hunter*  
SINCE 1886

# IT'S ALWAYS BEEN ALL ABOUT YOU

This year's improvements aren't part of a new strategy. Taking care of our customers has always been our focus. Here are a couple more reasons you should consider purchasing a Hunter® fan.

## Craftsmanship

It's what sets Hunter apart. It's at the heart of everything we put into our products – better motors, better materials, and innovative designs.

## Energy Efficiency

We don't just strive to give you a great value for your fan. We also work hard to create fans that will save you money every month on your utility bill.

To make it more convenient, we've included an informational energy chart for every ceiling fan. Please note that the energy data provided is for fans running at high speed.

Airflow <b>X,XXX</b> cfm	Electricity Use <b>XX</b> watt	Airflow Efficiency <b>XX</b> cfm/watt
-----------------------------	-----------------------------------	--

91 to 122cm ceiling fans have airflow efficiencies ranging from approximately 71 to 86 cubic feet per minute (CFM) per watt at high speed.

124 to 152cm ceiling fans have airflow efficiencies ranging from approximately 51 to 176 cubic feet per minute per watt at high speed.

### HUNTER® TIP

Remember, ceiling fans cool people, not rooms.  
So, turn the fan off when you leave the room to save energy.

## LEGEND



ETL Wet Rated



ETL Damp Rated



Low Ceiling

# FIND THE PERFECT FAN

We want you to be happy. This guide will help ensure you find the Hunter® fan that's just right for you.

## 1. Determine the fan that's best for your space.

---

Decide whether you need a fan for an indoor room, a covered porch, or an outdoor area.

Then, select your room size.

Room Size	Fan Size
Small rooms up to 3m x 3m	76cm to 122 cm fan
Large rooms up to 6m x 6m	127cm to 137 cm fan
Great rooms over 6m x 6m	142cm or larger fan

*If you're unsure about room dimensions, choose a larger fan to maximize your comfort at low or medium speed.*

## 2. Select a style.

---

For a coordinated look, match the blade finish to a room's furniture or wood molding.

Or, choose a fan body finish that matches door or cabinet hardware.

## 3. Choose the appropriate fan mount and accessories based on ceiling height.

---

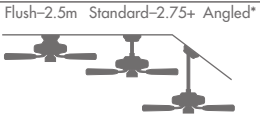
Low ceilings (2.5m)	Hunter® Low Profile® fans with motor housings that fit flush to the ceiling	
Standard ceilings (up to 2.75m)	Most Hunter® fans with the Installer's Choice® Three-Position Mounting System	
High or angled ceilings (2.75m)	Add an extension downrod (sold separately)	

## 4. Get the light right.

---

Choose a fan with a coordinated light fixture, or customize the fan with your choice of accessory light kit.

## 5. Pick out a fan control.

---

For convenient control of your Hunter® ceiling fan, choose a fan control that meets your needs.

- Select a wall control for easy operation from a single switch plate.
- Select a handheld remote control for easy operation anywhere in the room.

# TABLE OF CONTENTS

## HUNTER CEILING FANS

### MODERN

Central Park	8
Contempo	9
Lugano	10
Sonic	11
Merced	12

### LOFT

Eurus	12
Avalon	13
Tribeca	14
Flight	15
Carera	16
Soho	17
Industrie II	18
Nova	19
Galileo	20

### TROPICAL

Kohala Bay	21
Caribbean Breeze	21

## TRADITIONAL

Hunter Original	22
Savoy	23-24
Low Profile III	25
Seville II	26
Builder Elite	27
Builder Plus	28
Builder Deluxe	29
Bayport	30

## OUTDOOR

Cabo Frio	31
Maribel	32
Outdoor Elements II	33-34

SPECIFICATIONS	35-36
----------------	-------

## ACCESSORIES

Remote Controls/ Wall Controls	38
Globe Adapters & Glass	38
Accessory Light Kits	39
Extension Downrods	40
Blade Finishes	41

INDEX	42
-------	----





**50685**  
Hunter Original

# HUNTER

STAYING TRUE TO OUR NAME

From modern and hip to traditional and elegant, our mainstream collection has something for everyone. Every Hunter® design carries the same promise of quality and functionality.

# CENTRAL PARK NEW

- Motor size 172 mm x 12 mm
- 42 in or 107 cm blade span
- Two E27 sockets. Rated max. 20-Watt
- Wall control operated (included)
- Limited lifetime motor warranty



**50618**  
42"/107 cm Aged Steel with four  
Dark Walnut/Gray Walnut blades



**50619**  
42"/107cm Pewter Revival with four  
Black Oak/Roasted Oak blades

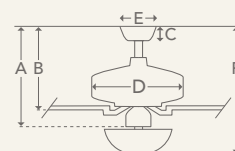

Dimensions (in)		Dimensions (cm)		Airflow
A:	9.54	A:	24.23	3,603 cfm
B:	9.36	B:	23.77	Electricity Use
C:	2.75	C:	6.98	48-watt
D:	—	D:	—	Airflow Efficiency
E:	6.49	E:	16.48	75 cfm/watt
F:	14.01	F:	35.59	



# CONTEMPO NEW

- Motor size 172 mm x 12 mm
- 52 in or 132 cm blade span
- Two E27 Sockets. Rated max 14-watt
- Wall control operated (included)
- Limited lifetime motor warranty

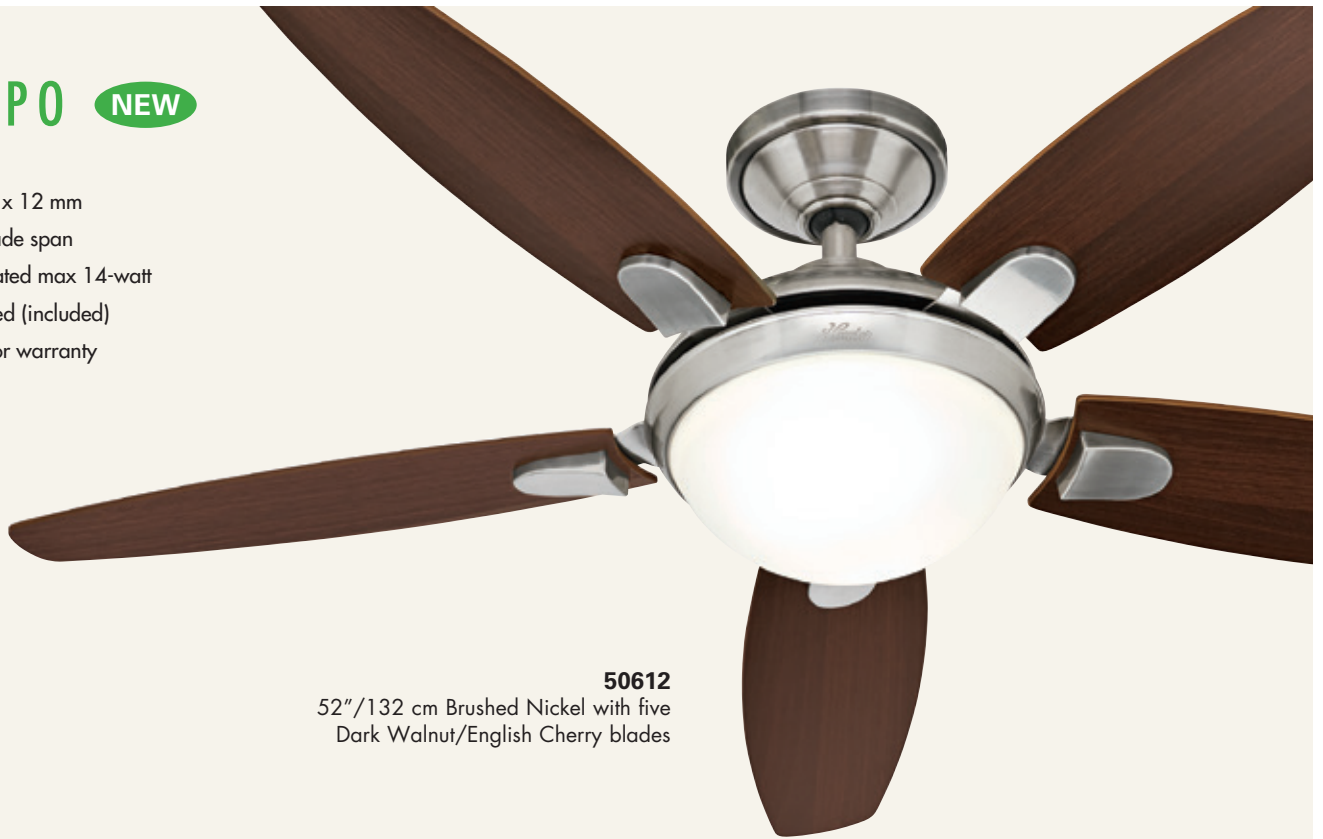

**50612**  
52"/132 cm Brushed Nickel with five  
Dark Walnut/English Cherry blades



**50613**  
52"/132 cm White with five  
White/Light Oak blades

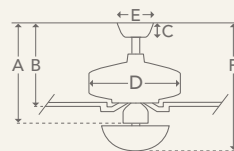

Dimensions (in)	Dimensions (cm)	Airflow
A: —	A: —	<b>3,937</b> cfm
B: <b>10.08</b>	B: <b>25.60</b>	Electricity Use
C: <b>2.75</b>	C: <b>6.98</b>	<b>51</b> -watt
D: <b>11.59</b>	D: <b>29.43</b>	Airflow Efficiency
E: <b>6.49</b>	E: <b>16.48</b>	<b>76</b> cfm/watt
F: <b>14.37</b>	F: <b>36.02</b>	

# LUGANO

- Motor Size: 188 mm x 20 mm
- 52 in or 132 cm blade span
- Uses one R7S 100-watt halogen bulb (not included)
- Wall control operated (included)
- Limited lifetime motor warranty

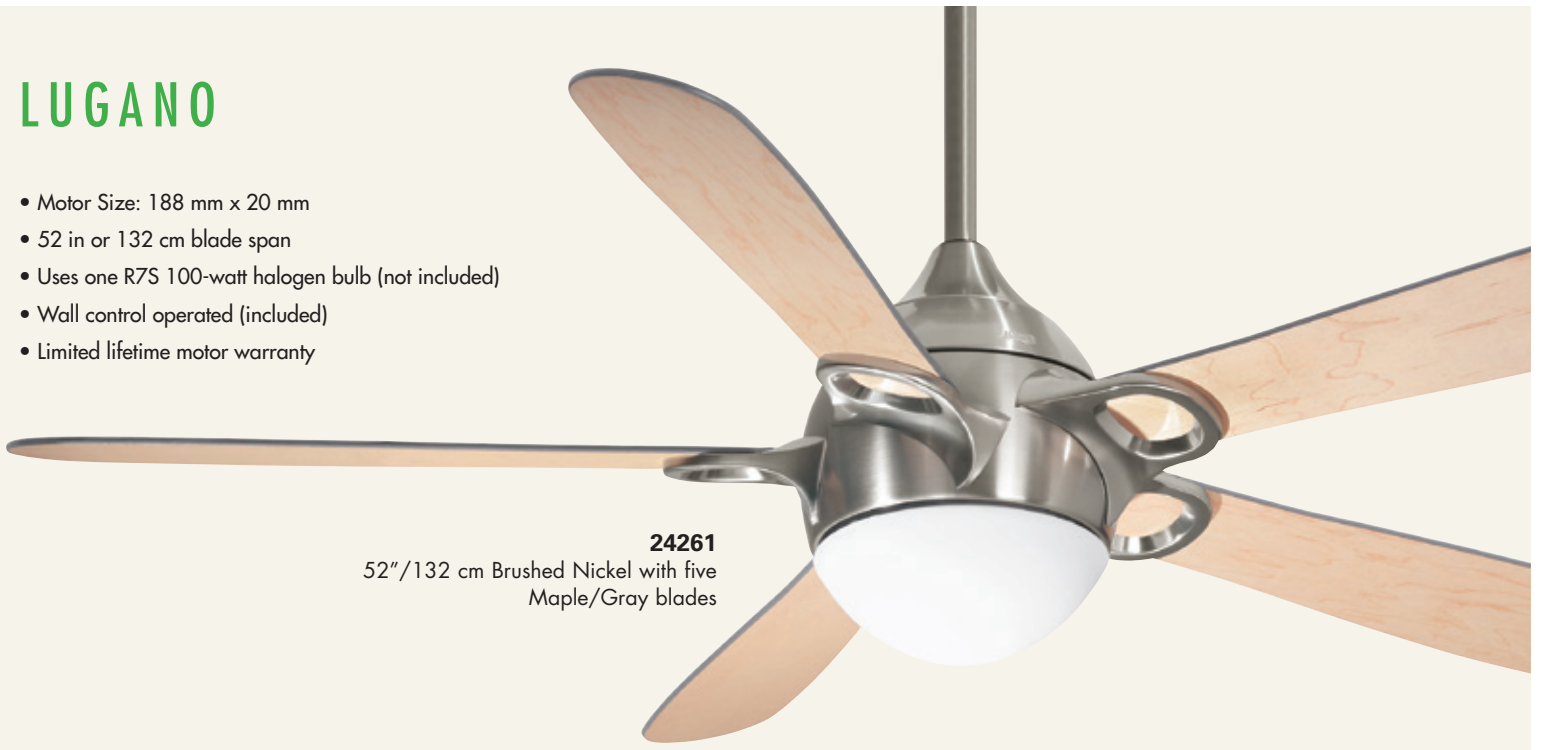

**24261**  
52"/132 cm Brushed Nickel with five  
Maple/Gray blades



**24266**  
52"/132 cm White with five  
White/Maple blades

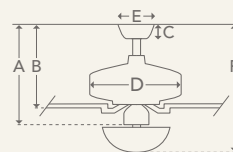

Dimensions (in)	Dimensions (cm)	Airflow
A: <b>13.20</b>	A: <b>33.53</b>	<b>5,374</b> cfm
B: <b>9.20</b>	B: <b>23.37</b>	Electricity Use
C: <b>3.25</b>	C: <b>8.26</b>	<b>64</b> -watt
D: <b>15.38</b>	D: <b>39.07</b>	Airflow Efficiency
E: <b>6.20</b>	E: <b>15.75</b>	<b>84</b> cfm/watt
F: <b>18.11</b>	F: <b>46.00</b>	

# SONIC

- Motor size: 172 mm x 20 mm
- 52 in or 132 cm blade span
- WhisperWind motor
- One E27 Socket. Rated max 13-watt
- Wall control operated (included)
- Limited lifetime motor warranty



**50666**  
52"/132 cm White with four  
White blades



**50665**  
52"/132 cm Brushed Nickel with four  
Gray blades

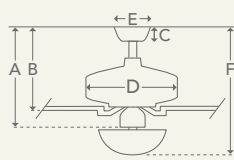

Dimensions (in)	Dimensions (cm)	Airflow
A: —	A: —	<b>5,456</b> cfm
B: <b>10.40</b>	B: <b>25.47</b>	Electricity Use
C: <b>2.81</b>	C: <b>7.13</b>	<b>61</b> -watt
D: <b>10.64</b>	D: <b>27.02</b>	Airflow Efficiency
E: <b>6.50</b>	E: <b>16.51</b>	<b>90</b> cfm/watt
F: <b>14.60</b>	F: <b>37.08</b>	

# MERCED

- Motor size: 153 mm x 20 mm
- 44 in or 112 cm blade span
- Uses one R7S 100-watt halogen bulb (not included)
- Limited lifetime motor warranty



**24086**

44"/112 cm Chalk White with three White/Beech blades

**24085**

44"/112 cm Brushed Nickel with three Gray/Maple blades

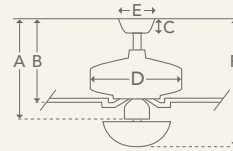

Dimensions (in)	Dimensions (cm)	
A: 12.25	A: 31.12	Airflow
B: 8.50	B: 21.59	4,056 cfm
C: 3.25	C: 8.26	Electricity Use
D: 7.00	D: 17.78	49-watt
E: 6.20	E: 15.75	Airflow Efficiency
F: 14.50	F: 36.83	83 cfm/watt

# EURUS NEW

- Motor size 172 mm x 20 mm
- 54 in or 137 cm blade span
- One E27 socket. Rated at max 20-watt
- Wall control operated (included)
- Limited lifetime motor warranty



**50611**

54"/137 cm Brushed Nickel with three Coffee Beech blades

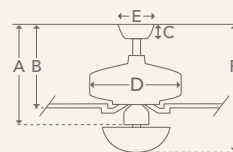

Dimensions (in)	Dimensions (cm)	
A: —	A: —	Airflow
B: 11.38	B: 28.91	6,402 cfm
C: 2.75	C: 6.98	Electricity Use
D: 9.66	D: 24.54	64-watt
E: 6.50	E: 16.51	Airflow Efficiency
F: 17.26	F: 43.84	99 cfm/watt

# AVALON

- Motor size: 172 mm x 15 mm
- 60 in or 152 cm blade span
- Three sailcloth blades (not reversible)
- Light kit adaptable
- Remote control operated (included)
- Limited lifetime motor warranty



**24282**  
60"/152 cm Brushed Nickel with three  
Gray Sailcloth blades

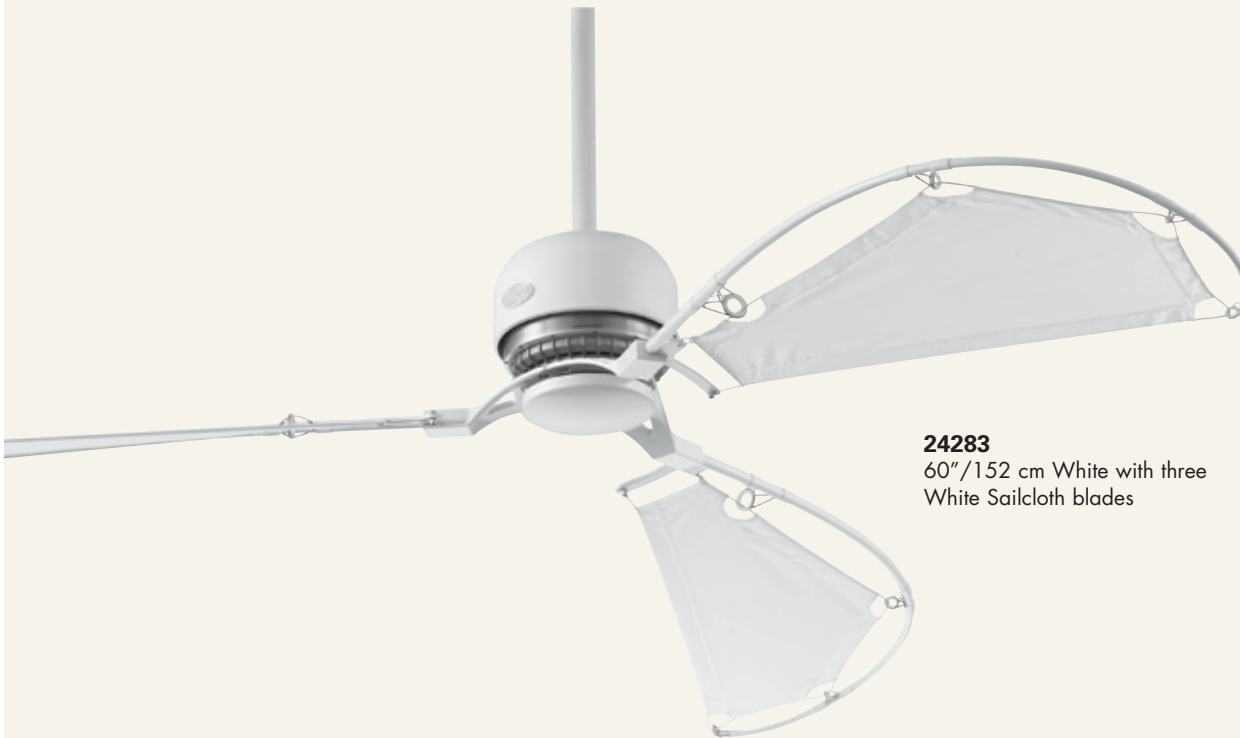

**24283**  
60"/152 cm White with three  
White Sailcloth blades

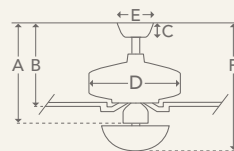

Dimensions (in)	Dimensions (cm)
A: <b>13.00</b>	A: <b>33.03</b>
B: <b>17.33</b>	B: <b>44.03</b>
C: <b>2.90</b>	C: <b>7.37</b>
D: <b>7.50</b>	D: <b>19.05</b>
E: <b>6.20</b>	E: <b>15.75</b>
F: —	F: —

Airflow	<b>5,536</b> cfm
Electricity Use	<b>70</b> -watt
Airflow Efficiency	<b>79</b> cfm/watt



# TRIBECA

- Motor size: 172 mm x 15 mm
- 60 in or 152 cm blade span
- AirMax motor
- Light kit adaptable
- Wall control operated (included)
- Limited lifetime motor warranty

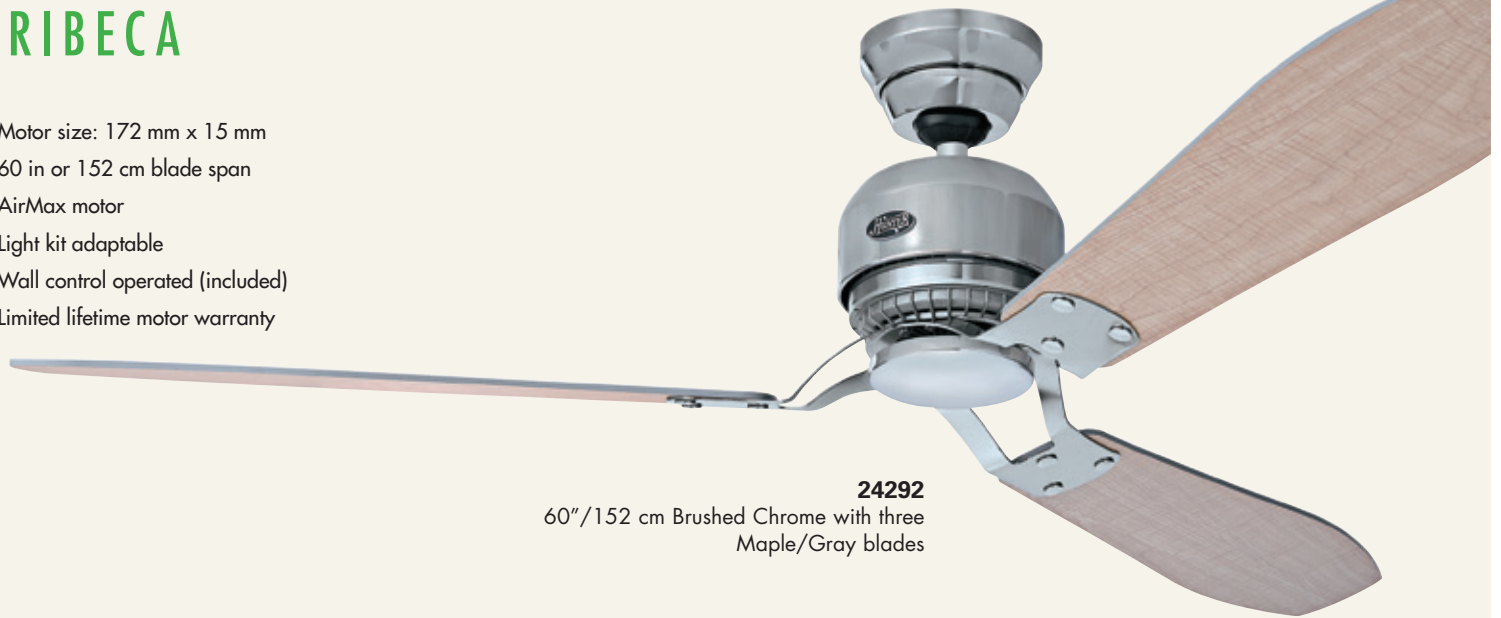

**24292**  
60"/152 cm Brushed Chrome with three  
Maple/Gray blades



**24297**  
60"/152 cm White with three  
White/Maple blades

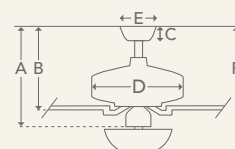

Dimensions (in)		Dimensions (cm)	
A:	13.00	A:	33.02
B:	14.43	B:	36.65
C:	3.25	C:	8.26
D:	7.50	D:	19.05
E:	6.20	E:	15.75
F:	—	F:	—

Airflow	<b>6,004</b> cfm
Electricity Use	<b>69</b> -watt
Airflow Efficiency	<b>86</b> cfm/watt

# FLIGHT

- Motor size: 172 mm x 20 mm
- 52 in or 132 cm blade span
- Three unique twisted blades
- Light kit adaptable
- Wall control operated (included)
- Limited lifetime motor warranty



**24230**  
52"/132 cm Brushed Nickel with three  
Coffee Beech blades



**24233**  
52"/132 cm White with three  
White blades

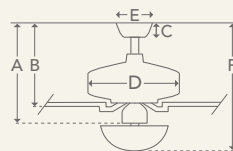

Dimensions (in)	Dimensions (cm)
A: 12.80	A: 32.51
B: 11.00	B: 27.94
C: 3.25	C: 8.26
D: 6.89	D: 17.50
E: 6.20	E: 15.75
F: —	F: —

Airflow	5,553 cfm
Electricity Use	66-watt
Airflow Efficiency	84 cfm/watt

# CARERA

- Motor size: 172 mm x 18 mm
- 52 in or 132 cm blade span
- AirMax motor
- Light kit adaptable
- Limited lifetime motor warranty

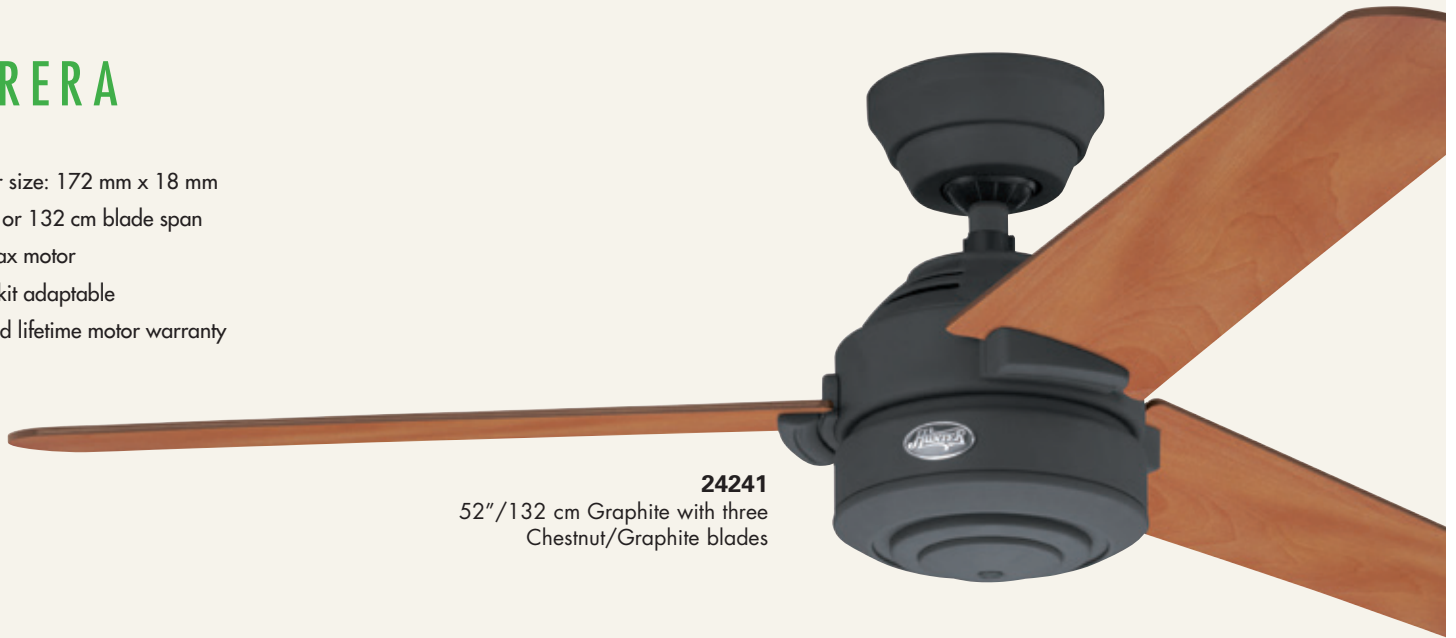

**24241**  
52"/132 cm Graphite with three  
Chestnut/Graphite blades



**24243**  
52"/132 cm Brushed Nickel with three  
Maple/Dark Walnut blades



**24246**  
52"/132 cm White with three  
White/Maple blades

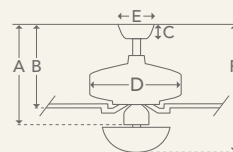

Dimensions (in)		Dimensions (cm)		Airflow
A:	12.68	A:	32.21	5,734 cfm
B:	8.50	B:	21.59	Electricity Use
C:	3.25	C:	8.26	65-watt
D:	8.00	D:	20.32	Airflow Efficiency
E:	6.20	E:	15.75	89 cfm/watt
F:	—	F:	—	

# SOHO

- Motor size: 172 mm x 15 mm
- 52 in or 132 cm blade span
- AirMax motor
- Light kit adaptable
- Wall control operated (included)
- Limited lifetime motor warranty



**24275**  
52"/132 cm Brushed Nickel with three  
Chocolate/Maple blades



**24277**  
52"/132 cm White with three  
White/Maple blades

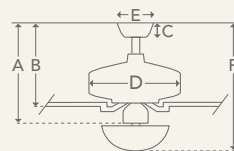

Dimensions (in)	Dimensions (cm)
A: 14.80	A: 37.59
B: 13.58	B: 34.49
C: 3.25	C: 8.26
D: 7.50	D: 19.05
E: 6.20	E: 15.75
F: —	F: —

Airflow	5,740 cfm
Electricity Use	78-watt
Airflow Efficiency	73 cfm/watt

# INDUSTRIE II

- Motor size: 172 mm x 15 mm
- 52 in or 132 cm blade span
- AirMax motor
- Light kit adaptable
- Wall control operated (included)
- Limited lifetime motor warranty

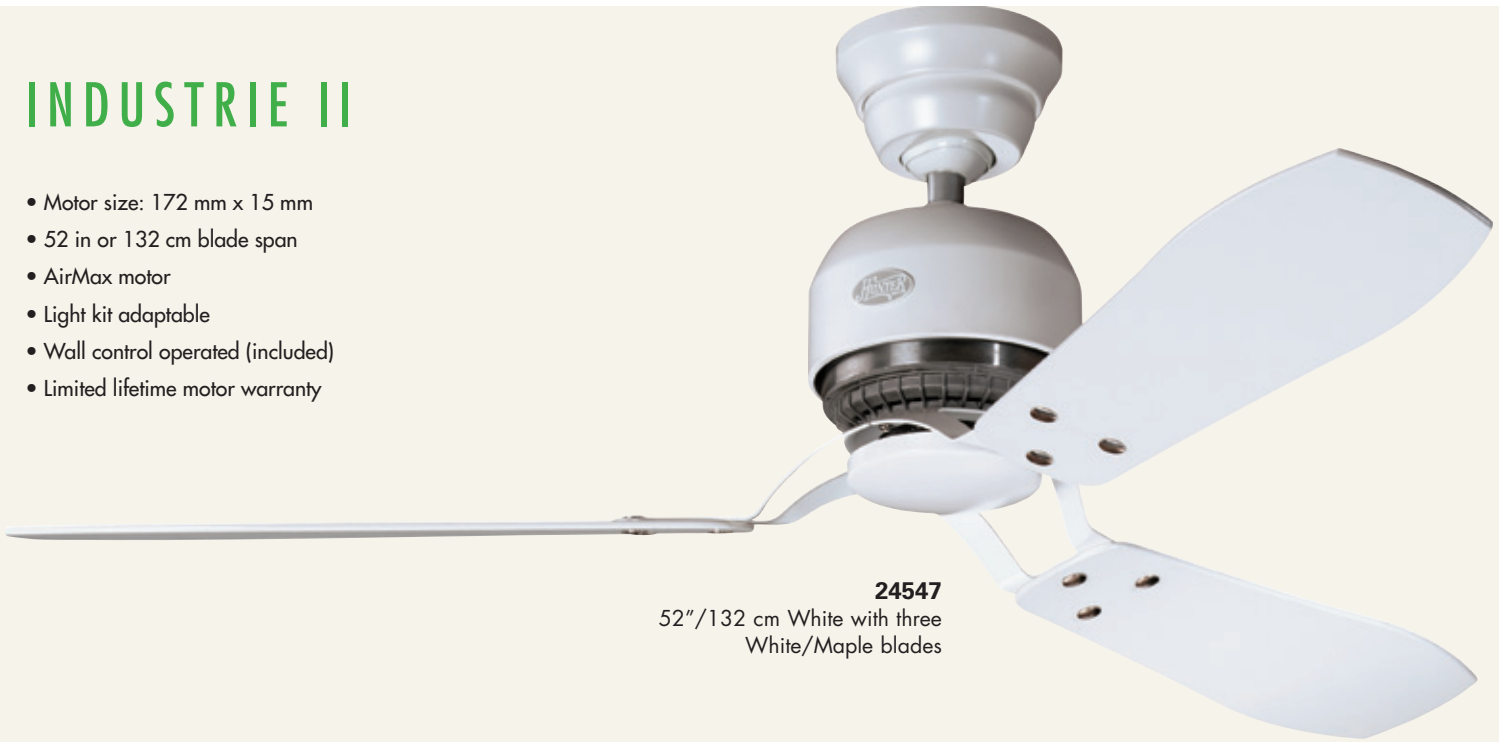

**24547**  
52"/132 cm White with three  
White/Maple blades

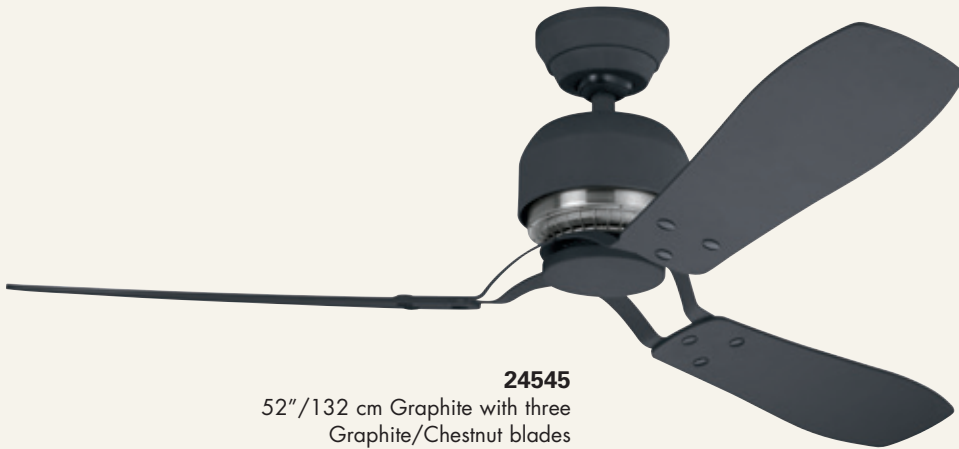

**24545**  
52"/132 cm Graphite with three  
Graphite/Chestnut blades



**24542**  
52"/132 cm Brushed Chrome with three  
Gray/Teak blades

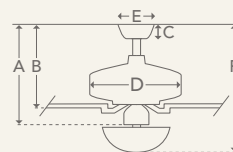

Dimensions (in)		Dimensions (cm)		Airflow
A:	13.00	A:	33.02	5,240 cfm
B:	14.43	B:	36.65	Electricity Use
C:	3.25	C:	8.26	66-watt
D:	7.50	D:	19.05	Airflow Efficiency
E:	6.20	E:	15.75	80 cfm/watt
F:	—	F:	—	



# NOVA **NEW**

- Motor size 172 mm x 12 mm
- 42 in or 107 cm blade span
- Two E27 Sockets. Rated max 14-watt
- Wall control operated (included)
- Limited lifetime motor warranty



**50616**  
42"/107 cm White with three  
Light Brown blades



**50617**  
42"/107 cm Matte Black with three  
Dark Walnut blades

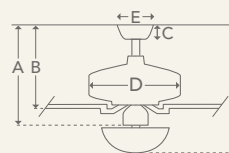

	Dimensions (in)	Dimensions (cm)
A:	9.15	23.24
B:	8.57	21.77
C:	2.75	6.98
D:	7.69	19.53
E:	6.49	16.48
F:	12.69	32.69

Airflow	3,731 cfm
Electricity Use	47-watt
Airflow Efficiency	79 cfm/watt

# GALILEO NEW

- Motor size 172 mm x 12 mm
- 48 in or 122 cm blade span
- Two E27 Sockets. Rated max 14-watt
- Wall control operated (included)
- Limited lifetime motor warranty



**50620**  
48"/122 cm Alpha Bronze with three  
Burnt Walnut/Roasted Walnut blades



**50621**  
48"/122 cm Brushed Nickel with three  
Dark Walnut/Dark Oak blades

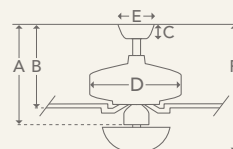

Dimensions (in)		Dimensions (cm)	
A:	—	A:	—
B:	9.09	B:	23.09
C:	2.75	C:	6.98
D:	7.65	D:	19.43
E:	6.49	E:	16.48
F:	13.57	F:	34.47

Airflow	<b>4,512</b> cfm
Electricity Use	<b>53</b> -watt
Airflow Efficiency	<b>75</b> cfm/watt

## KOHALA BAY NEW

- Motor size 172 mm x 12 mm
- 48 in or 122 cm blade span
- Can be installed without light kit
- Two E27 Sockets. Rated max 14-watt
- Limited lifetime motor warranty

**50610**  
48"/122 cm Antique Pewter with three  
Matte Black plastic blades

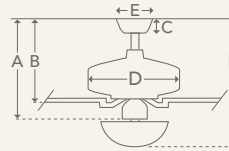

Dimensions (in)	Dimensions (cm)
A: 12.86	A: 32.66
B: 12.02	B: 30.53
C: 2.75	C: 6.98
D: 9.09	D: 23.09
E: 6.49	E: 16.48
F: 18.73	F: 47.57

Airflow	4,521 cfm
Electricity Use	60-watt
Airflow Efficiency	76 cfm/watt

## CARIBBEAN BREEZE

- Motor size: 172 mm x 15 mm
- 54 in or 137 cm blade span
- Can be installed without light kit
- Two E27 Sockets. Rated max 13-watt
- Not designed for outdoor use
- Limited lifetime motor warranty

**24457**  
54"/137 cm Weathered Bronze with five  
Antique Dark Wicker blades

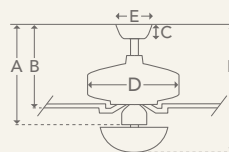

Dimensions (in)	Dimensions (cm)
A: 15.29	A: 38.84
B: 14.03	B: 36.32
C: 3.25	C: 8.26
D: 15.38	D: 39.07
E: 6.20	E: 15.75
F: 23.12	F: 58.72

Airflow	3,512 cfm
Electricity Use	57-watt
Airflow Efficiency	62 cfm/watt

# HUNTER® ORIGINAL

- Motor size 210 mm x 20 mm
- 50/60 dual-cycle motor
- 52 in or 132 cm blade span
- Furniture-grade veneer blades
- Indestructible cast iron housing
- Light kit adaptable
- Unique oil bath lubrication system
- Optional 4 or 5 blade installation
- Two hanging system options included:  
Original and Remote-Compatible
- Rated for damp locations
- Limited lifetime motor warranty



**50681**  
52"/132 cm White with five  
White blades



**50685**  
52"/132 cm Black with five  
Cherry/Walnut blades



CHOOSE TO INSTALL YOUR HUNTER ORIGINAL WITH FIVE BLADES  
OR FOR A MORE TRADITIONAL LOOK, INSTALL WITH FOUR BLADES



**22732**  
Oil for Hunter Original fans

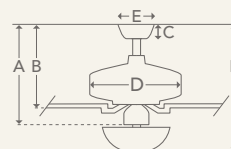

Dimensions (in)		Dimensions (cm)		Airflow
A:	14.04	A:	35.66	7,066 cfm
B:	11.85	B:	30.10	Electricity Use
C:	2.75	C:	6.98	69-watt
D:	12.53	D:	31.82	Airflow Efficiency
E:	6.49	E:	16.48	79 cfm/watt
F:	—	F:	—	

# SAVOY

- Motor size: 172 mm x 15 mm
- 52 in or 132 cm blade span
- Light kit adaptable
- Limited lifetime motor warranty



**24525**  
52"/132 cm Amber Bronze with five  
Distressed Cherry/Mahogany blades



**24521**  
52"/132 cm Brushed Nickel with five  
Maple/Cherry blades



**24524**  
52"/132 cm Bright Brass with five  
Rosewood/Oak blades



**SAVOY**  
(CONTINUED)



**24526**  
52"/132 cm White with five  
White/Light Oak blades



**24520**  
52"/132 cm Antique Brass with five  
Rosewood/Medium Oak blades

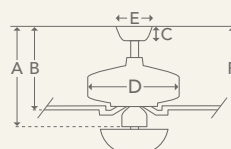

Dimensions (in)		Dimensions (cm)		Airflow
A:	12.50	A:	31.75	5,090 cfm
B:	11.50	B:	29.21	Electricity Use
C:	3.25	C:	8.26	65-watt
D:	11.88	D:	30.18	Airflow Efficiency
E:	6.20	E:	15.75	78 cfm/watt
F:	—	F:	—	

# LOW PROFILE III

- Motor size: 172 mm x 15 mm
- 52 in or 132 cm blade span
- WhisperWind motor
- Includes alternate 44 in or 112 cm blade span option
- Specially designed for low ceilings
- Light kit adaptable
- Limited lifetime motor warranty



**24377**  
52"/132 cm White with five  
White/Maple blades



**24372**  
52"/132 cm Brushed Nickel with five  
Chocolate/Maple blades

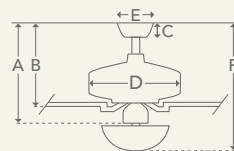

Dimensions (in)	Dimensions (cm)	Airflow
A: <b>9.21</b>	A: <b>23.39</b>	<b>2,810</b> cfm
B: <b>7.80</b>	B: <b>19.81</b>	Electricity Use
C: —	C: —	<b>74-watt</b>
D: <b>12.50</b>	D: <b>31.75</b>	Airflow Efficiency
E: —	E: —	<b>38</b> cfm/watt
F: —	F: —	

# SEVILLE II

- Motor size: 172 mm x 15 mm
- 44 in or 112 cm blade span
- Light kit adaptable
- Limited lifetime motor warranty



**24039**  
44"/112 cm New Bronze with five  
Medium Oak/Dark Cherry blades



**24034**  
44"/112 cm Antique Brass with five  
Walnut/Medium Oak blades



**24037**  
44"/112cm White with five  
White/Light Oak blades



**24038**  
44"/112cm Brushed Nickel with five  
Maple/Gray blades

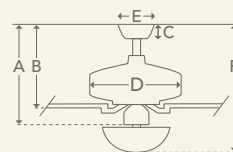

Dimensions (in)		Dimensions (cm)		Airflow
A:	13.00	A:	33.02	4,190 cfm
B:	10.91	B:	27.71	Electricity Use
C:	3.25	C:	8.26	62-watt
D:	10.71	D:	27.20	Airflow Efficiency
E:	6.20	E:	15.75	68 cfm/watt
F:	—	F:	—	

# BUILDER ELITE

- Motor size 172 mm x 12 mm
- WhisperWind motor
- 52 in or 132 cm blade span
- Limited lifetime motor warranty

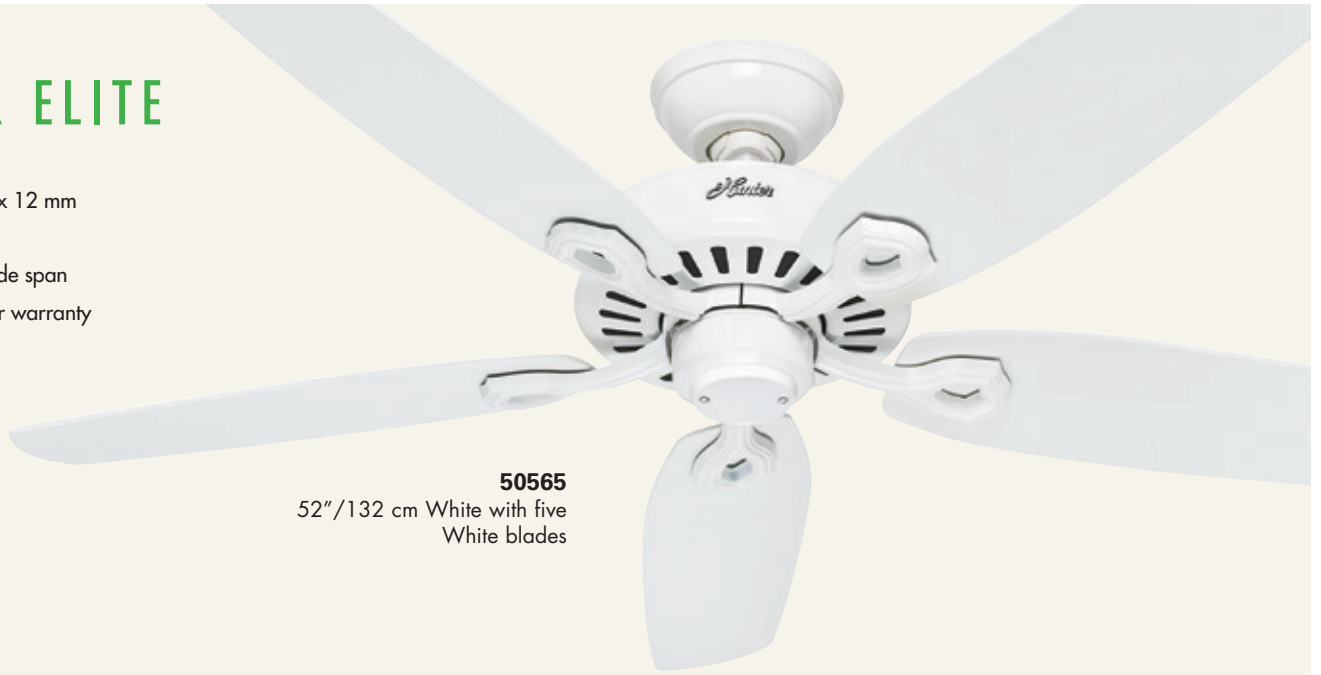

**50565**  
52"/132 cm White with five  
White blades



**50566**  
52"/132 cm Brushed Nickel with five  
Brazilian Cherry/Maple blades



**50567**  
52"/132 cm New Bronze with five  
Yellow Walnut/Brazilian Cherry blades

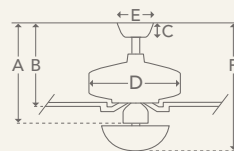

Dimensions (in)	Dimensions (cm)	Airflow
A: 12.33	A: 31.30	4,845 cfm
B: 10.99	B: 27.90	Electricity Use
C: 2.83	C: 7.20	66-watt
D: 10.90	D: 27.70	Airflow Efficiency
E: 6.49	E: 16.50	79 cfm/watt
F: —	F: —	

# BUILDER PLUS

- Motor size 172 mm x 12 mm
- WhisperWind motor
- 52 in or 132 cm blade span
- Three E27 Sockets. Rated max 14-watt
- Limited lifetime motor warranty

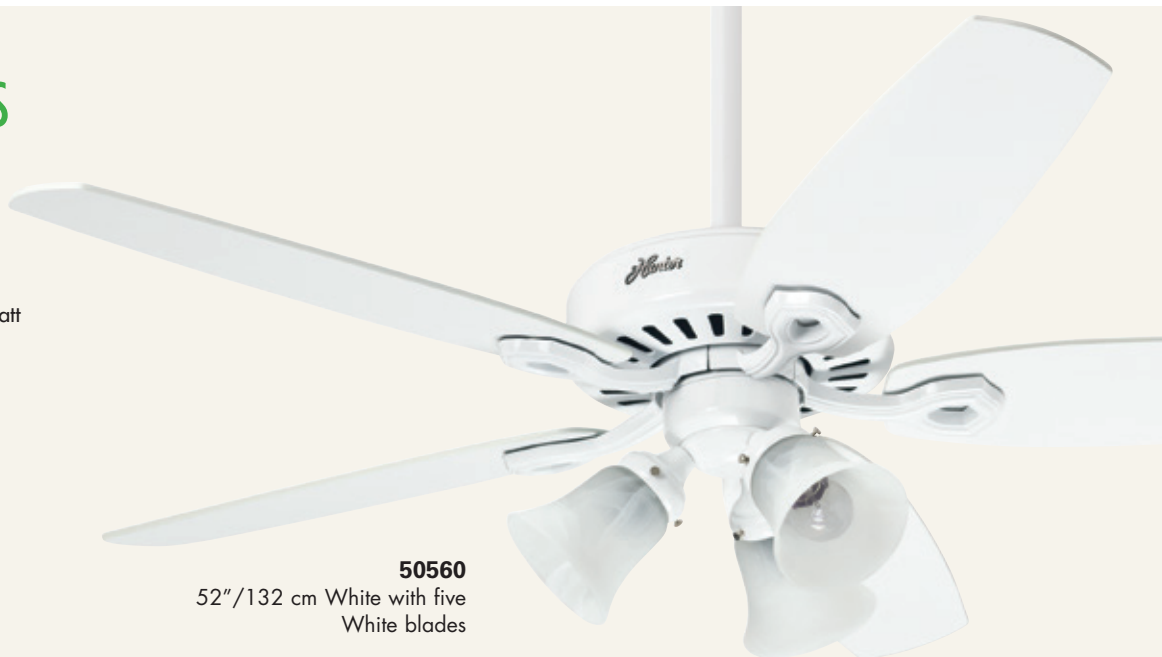

**50560**  
52"/132 cm White with five  
White blades



**50561**  
52"/132cm Brushed Nickel with five  
Brazilian Cherry/Burnt Walnut blades



**50562**  
52"/132cm New Bronze with five  
Brazilian Cherry/Yellow Walnut blades

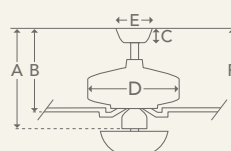

Dimensions (in)		Dimensions (cm)		Airflow
A:	12.33	A:	31.30	4,845 cfm
B:	10.99	B:	27.90	Electricity Use
C:	2.75	C:	6.98	66-watt
D:	10.90	D:	27.70	Airflow Efficiency
E:	6.49	E:	16.50	74 cfm/watt
F:	18.13	F:	46.10	



# BUILDER DELUXE

- Motor size 172 mm x 12 mm
- WhisperWind motor
- 52 in or 132 cm blade span
- Two E27 Sockets. Rated max 60-watt
- Limited lifetime motor warranty



**50570**  
52"/132 cm White with five  
White/Beech blades



**50571**  
52"/132cm Brushed Nickel with five  
Brazilian Cherry/Burnt Walnut blades



**50572**  
52"/132cm New Bronze with five  
Yellow Walnut/Brazilian Cherry blades

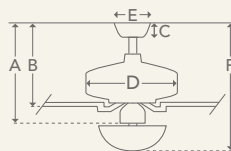

Dimensions (in)	Dimensions (cm)	Airflow
A: 12.33	A: 31.32	4,845 cfm
B: 10.99	B: 27.90	Electricity Use
C: 2.75	C: 6.98	66-watt
D: 10.90	D: 27.70	Airflow Efficiency
E: 6.49	E: 16.50	79 cfm/watt
F: 17.84	F: 45.30	

# BAYPORT

- Motor size: 172 mm x 12 mm
- 42 in or 107 cm blade span
- WhisperWind motor
- Light kit adaptable
- Limited lifetime motor warranty

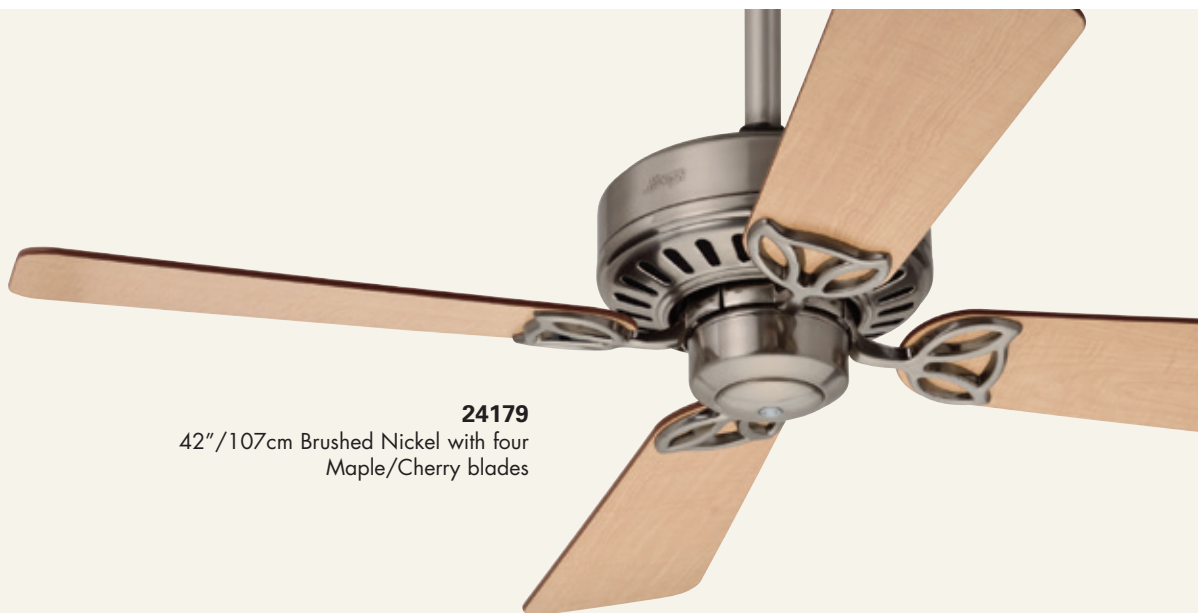

**24179**  
42"/107cm Brushed Nickel with four  
Maple/Cherry blades



**24170**  
42"/107cm White with four  
White/Light Oak blades



**24174**  
42"/107cm Antique Brass with four  
Rosewood/Medium Oak blades

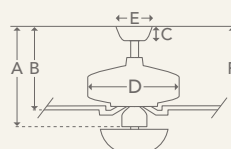

Dimensions (in)		Dimensions (cm)		Airflow
A:	13.85	A:	35.2	4,155 cfm
B:	11.05	B:	28.1	Electricity Use
C:	3.25	C:	8.3	58-watt
D:	9.50	D:	24.1	Airflow Efficiency
E:	6.20	E:	15.7	72 cfm/watt
F:	—	F:	—	

# CABO FRIO

- Motor size: 172 mm x 20 mm
- 52 in or 132 cm blade span
- ETL Damp-Listed for use in covered porches, patios, and sunrooms
- Three unique twisted blades
- Not suited for coastal locations
- Wall-control operated (included)
- Limited lifetime motor warranty



**24234**  
52"/132 cm White with three  
White blades



**24235**  
52"/132 cm New Bronze with three  
Coffee Beech blades

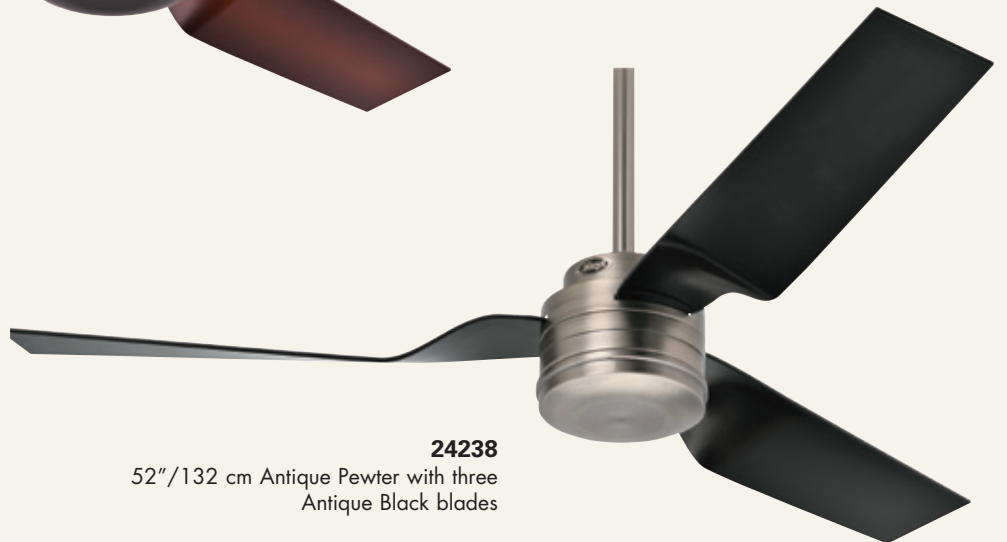

**24238**  
52"/132 cm Antique Pewter with three  
Antique Black blades

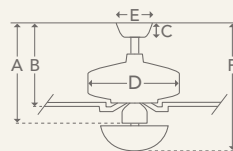

Dimensions (in)	Dimensions (cm)	Airflow
A: 12.80	A: 32.51	5,957 cfm
B: 10.98	B: 27.89	Electricity Use
C: 3.25	C: 8.26	72-watt
D: 6.90	D: 17.53	Airflow Efficiency
E: 6.20	E: 15.75	83 cfm/watt
F: —	F: —	

# MARIBEL

- Motor size: 172 mm x 20 mm
- 52 in or 132 cm blade span
- Aluminum housing with stainless steel hardware
- ETL Wet-Listed for use in covered and uncovered applications
- Light kit adaptable
- Limited lifetime motor warranty

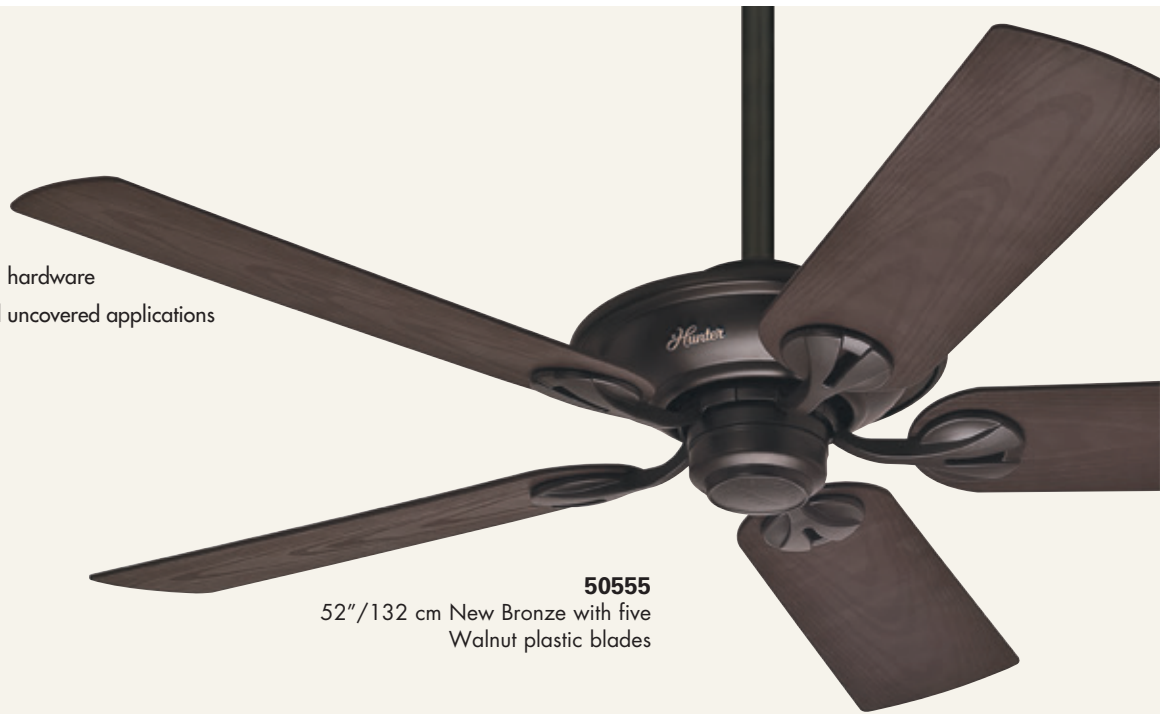

**50555**  
52"/132 cm New Bronze with five  
Walnut plastic blades



**50557**  
52"/132 cm White with five  
White plastic blades

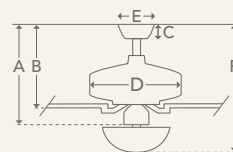

Dimensions (in)		Dimensions (cm)		Airflow
A:	12.60	A:	32.00	5,753 cfm
B:	11.37	B:	28.88	Electricity Use
C:	2.75	C:	6.98	66-watt
D:	12.20	D:	30.99	Airflow Efficiency
E:	6.49	E:	16.48	87 cfm/watt
F:	—	F:	—	

# OUTDOOR ELEMENTS II

- Motor size 172 mm x 20 mm
- 52 in or 132 cm blade span
- Aluminum housing with stainless steel hardware
- ETL Wet-Listed for use in wet or covered applications
- Light kit adaptable
- Limited lifetime motor warranty



**24324**  
52"/132 cm Weathered Brick with five Solid Teak blades



**24326**  
52"/132 cm White with five White plastic blades

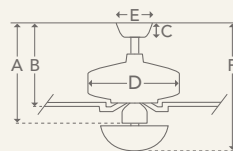

Dimensions (in)	Dimensions (cm)	Airflow
A: 13.25	A: 33.66	4,663 cfm
B: 11.50	B: 29.21	Electricity Use
C: 3.25	C: 8.26	60-watt
D: 11.50	D: 29.21	Airflow Efficiency
E: 6.20	E: 15.75	78 cfm/watt
F: —	F: —	

# OUTDOOR ELEMENTS II

- Motor size: 172 mm x 20 mm
- 54 in or 137 cm blade span
- ETL Wet-Listed for use in wet or covered applications
- Aluminum housing with stainless steel hardware
- Light kit adaptable
- Limited lifetime motor warranty

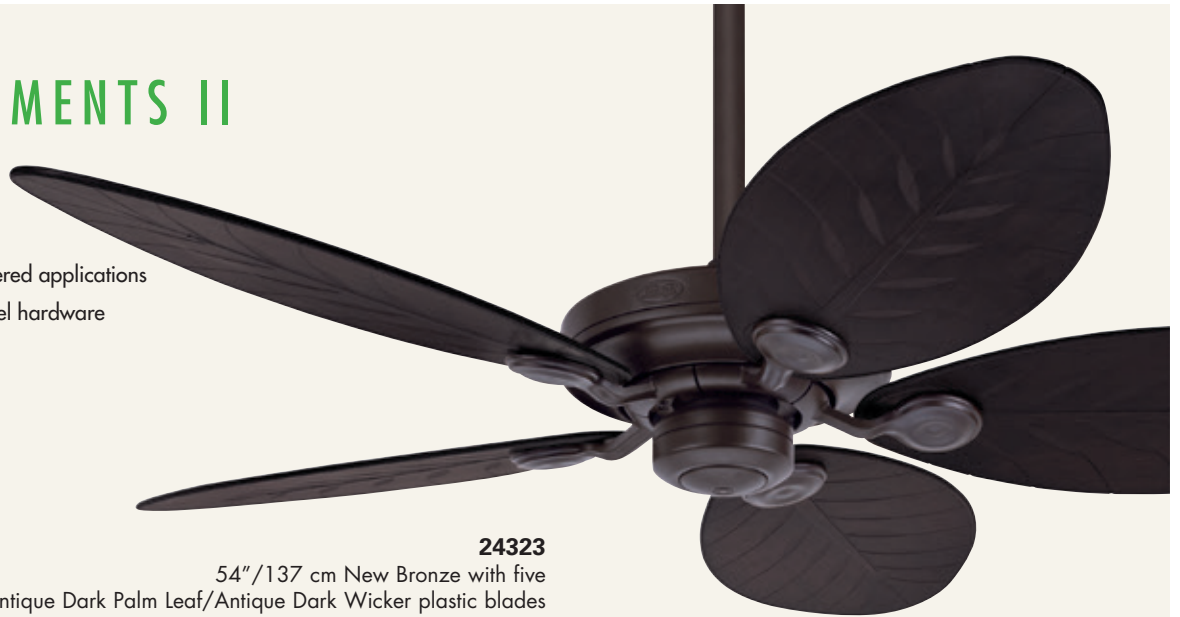

**24323**  
54"/137 cm New Bronze with five  
Antique Dark Palm Leaf/Antique Dark Wicker plastic blades



**24325**  
54"/137 cm Raw Aluminum with five  
Natural Palm Leaf/Natural Wicker plastic blades

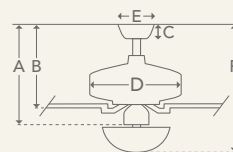

Dimensions (in)		Dimensions (cm)		Airflow
A:	13.25	A:	33.66	4,663 cfm
B:	11.50	B:	29.21	Electricity Use
C:	3.25	C:	8.26	60-watt
D:	11.50	D:	29.21	Airflow Efficiency
E:	6.20	E:	15.75	78 cfm/watt
F:	—	F:	—	



# SPECIFICATIONS

	<i>Avalon</i> 24282, 24283	<i>Boysport</i> 24170, 24174, 24179	<i>Builder Deluxe</i> 50570, 50571, 50572	<i>Builder Elite</i> 50565, 50566, 50567	<i>Builder Plus</i> 50560, 50561, 50562	<i>Cabo Frito</i> 24234, 24235, 24238	<i>Carrera</i> 24241, 24243, 24246	<i>Caribbean Breeze</i> 24457	<i>Central Park</i> 50618, 50619	<i>Contempo</i> 50612, 50613	<i>Eurus</i> 50611	<i>Flight</i> 24230, 24233	<i>Galileo</i> 50620, 50621	<i>Hunter Original</i> 50681, 50685
SIZE (INCHES)	60	42	52	52	52	52	52	52	42	52	54	52	48	52
SIZE (CM)	152	107	132	132	132	132	132	132	107	132	137	132	122	132
BLADES	3	4	5	5	5	3	3	5	4	5	3	3	3	4/5
INCLUDES LIGHT	No	No	Yes	No	Yes	No	No	Yes	Yes	Yes	Yes	No	Yes	No
WALL CONTROL	No	No	No	No	No	Yes	No	No	Yes	Yes	Yes	Yes	Yes	No
REMOTE	Yes	No	No	No	No	No	No	No	No	No	No	No	No	No
CFM (HIGH)	5536	4155	4845	4845	4845	5957	5734	3512	3604	3937	6402	5553	4512	7066
CFM (MED)	3985	3174	3933	3933	3933	4233	4229	3192	3321	3537	5460	4728	4093	5420
CFM (LOW)	2204	1928	2776	2776	2776	2479	2566	1807	2422	2688	3402	2254	2864	2926
RPM (HIGH)	104	253	159	159	159	190	208	215	227	132	190	165	192	200
RPM (MED)	80	201	120	120	120	135	161	195	208	117	153	138	168	125
RPM (LOW)	52	127	74	74	74	73	101	118	144	80	86	73	113	49
WATTS	70	58	66	66	66	72	65	57	48	52	65	66	60	69
AMPS	.29	.24	.28	.28	.28	.30	.27	.24	.20	.22	.28	.27	.26	.29
A	13.00	13.85	12.33	12.33	12.33	13.80	12.68	15.29	9.54	—	—	12.80	—	14.04
B	17.33	11.05	10.99	10.99	10.99	10.98	8.50	14.03	9.36	10.08	11.38	11.00	9.09	11.85
C	2.90	3.25	2.75	2.83	2.75	3.25	3.25	3.25	2.75	2.75	2.75	3.25	2.75	2.75
D	7.50	9.50	10.90	10.90	10.90	6.90	8.00	15.38	—	11.59	9.66	6.89	7.65	12.53
E	6.20	6.20	6.49	6.49	6.49	6.20	6.20	6.20	6.49	6.49	6.50	6.20	6.49	6.49
F	—	—	17.84	—	18.13	—	—	23.12	14.01	14.01	17.26	—	13.57	—

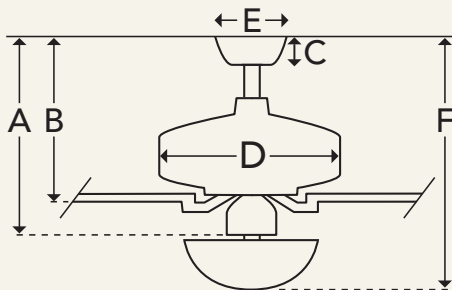

# SPECIFICATIONS (CONTINUED)

	<i>Industrie II</i> 24542, 24545, 24547	<i>Kohala Bay</i> 50610	<i>Low Profile</i> 24372, 24377	<i>Lugano</i> 24280, 24286	<i>Maribel</i> 50535, 50537	<i>Merced</i> 24085, 24086	<i>Nova</i> 50616, 50617	<i>Outdoor Elements</i> 24324, 24326	<i>Outdoor Elements II</i> 24323, 24325	<i>Savoy</i> 24520, 24521, 24524 24525, 24526	<i>Seville</i> 24034, 24037, 24038, 24039	<i>Soho</i> 24275, 24277	<i>Sonic</i> 50665, 50666	<i>Tribeca</i> 24292, 24297
SIZE (INCHES)	52	48	52/44	52	52	44	42	52	54	52	44	52	52	60
SIZE (CM)	132	122	132/112	132	132	112	107	132	137	132	112	132	132	152
BLADES	3	3	5	5	5	3	3	5	5	5	5	3	4	3
INCLUDES LIGHT	No	Yes	No	Yes	No	Yes	Yes	No	No	No	No	No	Yes	No
WALL CONTROL	Yes	No	No	No	No	No	Yes	No	No	No	No	Yes	Yes	Yes
REMOTE	No	No	No	No	No	No	No	No	No	No	No	No	No	No
CFM (HIGH)	5240	4521	2810	5374	5753	4056	3730	4663	4663	5089	4190	5740	5456	6004
CFM (MED)	4429	3781	1998	4421	3987	3578	3447	4165	4165	4349	3825	3530	4642	4783
CFM (LOW)	3022	2603	1188	2651	2393	2675	2480	2392	2392	2899	2514	1720	2818	3330
RPM (HIGH)	157	215	210	165	171	267	214	143	143	183	232	217	233	130
RPM (MED)	127	173	153	134	130	238	192	132	132	152	205	143	191	98
RPM (LOW)	79	112	85	79	86	173	135	83	83	98	127	76	113	60
WATTS	66	60	74	64	66	49	47	60	60	65	62	78	61	69
AMPS	.27	.26	.30	.87	.29	.20	.20	.26	.26	.27	.26	.66	N/A	.29
A	13.00	12.86	9.21	13.20	12.60	12.25	9.15	13.25	13.25	12.50	13.00	14.80	—	13.00
B	14.43	12.02	7.80	9.20	11.37	8.50	8.57	11.50	11.50	11.50	10.91	13.58	10.40	14.43
C	3.25	2.75	—	3.25	2.75	3.25	2.75	3.25	3.25	3.25	3.25	3.25	2.81	3.25
D	7.50	9.09	12.30	15.38	12.20	7.00	7.69	11.50	11.50	11.88	10.71	7.50	10.64	7.50
E	6.20	6.49	—	6.20	6.49	6.20	6.49	6.20	6.20	6.20	6.20	6.20	6.50	6.20
F	—	18.73	—	—	—	—	12.69	—	—	—	—	—	14.60	—

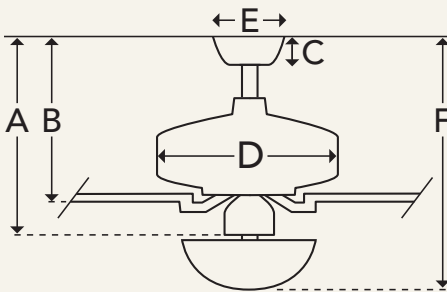



# ACCESSORIES

---

BEYOND FANS

Once you've found the perfect fan, add the right touches with our assortment of finishes, fixtures and fan accessories. Each made with the same quality and innovation that go into every Hunter® collection.

# REMOTE CONTROLS & WALL CONTROLS

**NEW**



**99117**  
**Three-Speed Remote Control**

- 3-speed fan control
- Light dimming
- Includes 2 wall plates: square and rectangular
- Blister packaging
- Shelf-ready display



**24756**  
**RF Remote Control**

- 3-speed fan control
- Light dimming
- Low battery indicator



**24750**  
**Speedboat Remote Control**

- 3-speed fan control plus instant "off"
- Light dimming



**24757**  
**Ceiling Fan Control with Light**

- 3-speed fan control
- On/off light control
- 240V
- 300-watt light
- Includes 2 wall plates: square and rectangular
- Blister packaging
- Shelf-ready display



**NEW**

**24758**  
**Ceiling Fan Control**

- 3-speed fan control
- 240V
- 300-watt light
- Includes 2 wall plates: square and rectangular
- Blister packaging
- Shelf-ready display



# GLOBE ADAPTERS & GLASS



**Globe Adapter**

- 24432 - White (shown)
- 24434 - Bright Brass
- 24435 - Brushed Chrome



**Opal Schoolhouse Globe**

- 22515 - 8" Globe (shown)
- 22555 - 10" Globe
- Glass only



**Contemporary Schoolhouse Globe**

- 22565
- Glass only

# ACCESSORY LIGHT KITS



## Scavo Bowl

24122

Includes finials in Brushed Nickel, Satin Brass, White, and Bright Brass

Two E27 sockets

Rated at max 60-watt



## Amber Bowl

24125

Includes finials in New Bronze, Amber Bronze, Antique Brass, and Weathered Bronze

Two E27 sockets

Rated at max 60-watt



## Frosted Opal Bowl

24126

Includes finials in Brushed Nickel, Bright Brass, Antique Brass, White, and New Bronze

Two E27 sockets

Rated at max 60-watt



## Swirled Marble Bowl

24127

Includes finials in Brushed Nickel, Bright Brass, Antique Brass, White, and New Bronze

Two E27 sockets

Rated at max 60-watt



## Wicker Bowl

24120 Weathered Bronze

Two E27 sockets

Rated at max 60-watt



## Flight Light Kit

50900

Includes finials in White and Brushed Nickel

Two E27 sockets

Rated at max 13-watt



## Contemporary Light Kit

24301 Brushed Nickel (shown)

24304 Graphite

24307 White

Two E27 sockets

Rated at max 60-watt



## 3 Light Flush Mount

24310 - Antique Brass

24312 - Bright Brass

24316 - White

24318 - Brushed Nickel

24319 - New Bronze (shown)

Three E27 sockets

Rated at max 60-watt

NEW



## Angra Outdoor Light Kit

50910 - New Bronze (shown)

50911 - White

One E27 socket

Rated at max 60-watt



## Outdoor Light Kit

24335 - New Bronze (shown)

24336 - White

24337 - Raw Aluminum

Two E27 sockets

Rated at max 13-watt

# EXTENSION DOWNRODS

More homes are being constructed with high ceilings. A Hunter® ¾" downrod sets the fan at the proper height for optimum performance. All Hunter® extension downrods match Hunter® fans for fit and finish, and have tapered threads for deeper engagement.

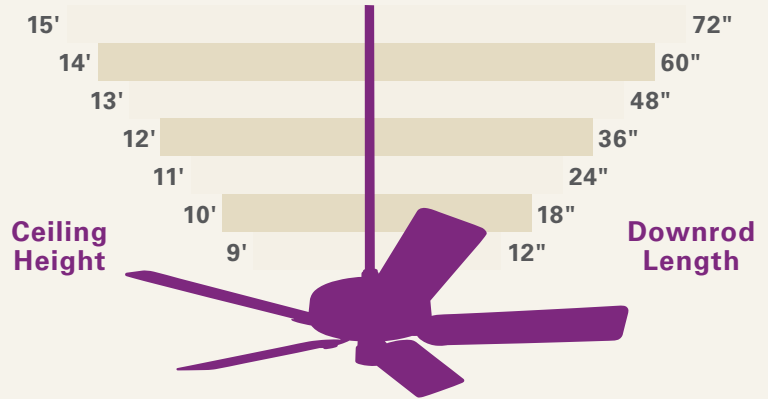

Finish	12"	18"	24"	36"	48"	60"	72"	Compatible Finishes
Antique Brass	22719	22729	26319	26329	26339	23190	23060	Burnished Copper, Estate Brass
Antique Pewter	28054	28055	28056	28057	28058	28059	28060	Pewter Revival
Black	25144	25145	25146	25147	25148	25149	25150	Antique Black, Matte Black, Satin Black, Textured Black, Graphite, Iron
Brittany Bronze	28979	—	28980	28981	—	—	—	Weathered Bronze, Burlled Brown
Bronze Patina	28206	28207	28208	28209	28210	—	—	Amber Bronze, Antique Copper, Brushed Bronze, Satin Bronze
Brushed Nickel	26019	26020	26021	26022	26023	26024	26025	Brushed Chrome
Harvest Wheat	28976	—	28977	28978	—	—	—	Harvest Wheat
Hunter Bright Brass Finish	22713	22723	26313	26323	26333	23192	23062	—
Iron	22685	22686	22687	—	—	—	—	—
New Bronze	26041	26042	26043	26044	26045	26046	26047	Bronze, Brushed Cocoa, Leather Bronze, Provencal Gold, Roman Bronze, Rustic Bronze, Tuscan Gold, Egyptian Bronze
Provencal Gold	28224	28225	28226	28227	28228	—	—	New Bronze
Weathered Brick	22681	—	—	26010	26011	—	—	Alpha Bronze
White	25136	25137	25138	25139	25140	25141	25142	Satin White

## Outdoor Elements and Maribel - "All Weather" Downrods • Rust-proof Stainless Steel Construction

Satin White	—	—	—	25159	—	—	—	—
Textured Black	—	25162	25163	25164	—	—	—	—
Weathered Brick	26434	—	26436	26437	—	—	—	—
Raw Aluminum*	28248	28249	28250	28251	—	—	—	—

## Hunter Original® Downrods • Double-Threaded Construction

Black	26302	26219	26227	26228	26229	23194	23064	—
Chestnut Brown	22711	22721	26331	26341	26351	23195	23065	Distressed Relic, Chestnut Bronze, Weathered Brick
New Bronze All-Weather	25998	25999	26007	26008	—	—	—	Midnight Copper, Weathered Brick, Weathered Bronze
Satin White All-Weather	28254	28255	28256	28257	28258	—	—	—
Textured Black All-Weather	26430	26431	26432	26433	—	—	—	—
White	22717	22727	26317	26327	26337	23197	23067	—

## Vaulted Ceiling Mounts - For up to 45° angle mount

Colors	Chestnut Brown	Hunter Bright Brass Finish	Black	Brushed Nickel	White	Antique Brass	Antique Pewter	New Bronze
Item number	22170	22172	22174	22175	22176	22178	27995	27996



# BLADE FINISHES



Antique Dark Palm Leaf

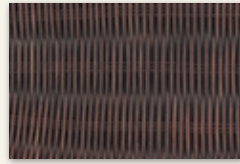

Antique Dark Wicker



Beech

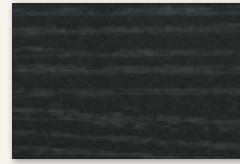

Black Oak



Brazilian Cherry



Burnt Walnut



Cherry



Chestnut



Chocolate

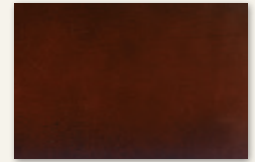

Coffee Beech

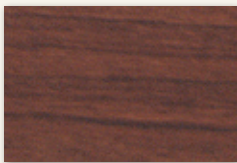

Dark Cherry



Dark Oak

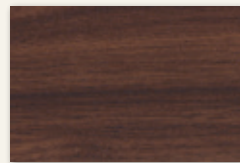

Dark Walnut



Distressed Cherry



English Cherry

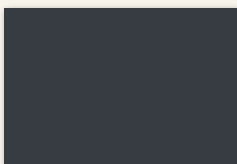

Graphite

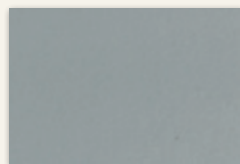

Gray



Gray Walnut

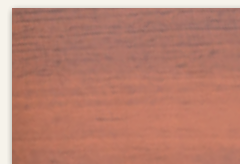

Light Brown



Light Oak

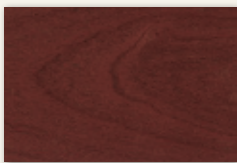

Mahogany

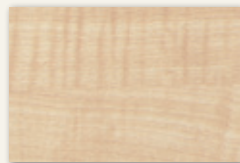

Maple

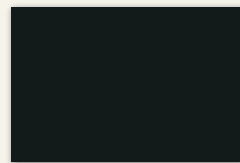

Matte Black

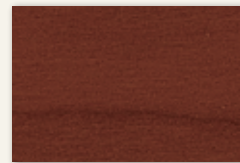

Medium Cherry

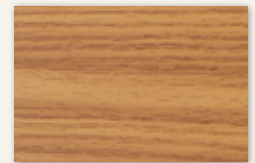

Medium Oak



Natural Wicker

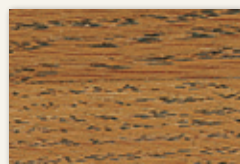

Oak



Palm Leaf

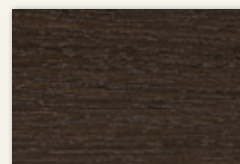

Roasted Oak

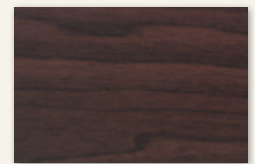

Roasted Walnut

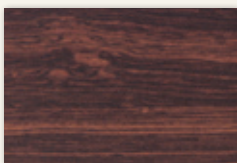

Rosewood

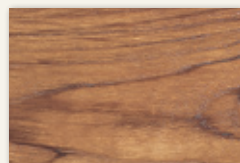

Solid Teak

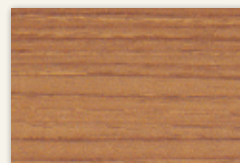

Teak

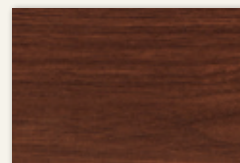

Walnut

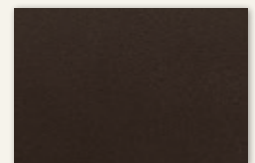

Walnut Plastic

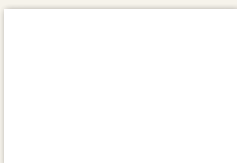

White

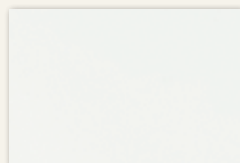

White Plastic

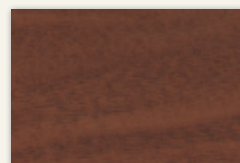

Yellow Walnut

# ALPHABETICAL INDEX

Fan Name	Page	Style	Models
Avalon	13	Loft	24282, 24283
Bayport	30	Traditional	24170, 24174, 24179
Builder Deluxe	29	Traditional	50570, 50571, 50572
Builder Elite	27	Traditional	50565, 50566, 50567
Builder Plus	28	Traditional	50560, 50561, 50562
Cabo Frio	31	Outdoor Damp	24234, 24235, 24238
Carera	16	Loft	24241, 24243, 24246
Caribbean Breeze	21	Loft	24457
Central Park	8	Modern	50618, 50619
Contempo	9	Modern	50612, 50613
Eurus	12	Modern	50611
Flight	15	Loft	24230, 24233
Galileo	20	Loft	50620, 50621
Hunter Original	22	Loft	50681, 50685
Industrie II	18	Loft	24542, 24545, 24547
Kohala Bay	21	Loft	50610
Low Profile III	25	Traditional	24372, 24377
Lugano	10	Modern	24261, 24266
Maribel	32	Outdoor Wet	50555, 50557
Merced	12	Modern	24085, 24086
Nova	19	Loft	50616, 50617
Outdoor Elements II	33-34	Outdoor Wet	24324, 24326, 24323, 24325
Savoy	23-24	Traditional	24520, 24521, 24524, 24525, 24526
Seville II	26	Traditional	24034, 24037, 24038, 24039
Soho	17	Loft	24275, 24277
Sonic	11	Modern	50665, 50666
Tribeca	14	Loft	24292, 24297

*Hunter*  
SINCE 1886  
KEEPING YOU IN MIND.



As we continue to create innovative products of the highest quality,  
you can rest assured that we'll keep you in mind every step of the way.



HUNTER FAN COMPANY  
7130 Goodlett Farms Pkwy, Suite 400  
Memphis, TN 38016  
[www.HunterFan.com](http://www.HunterFan.com)  
+1.901.744.1200