



superlux
we engineer light

Specifiers Product Guide:

10

This catalogue introduces our complete range of lighting and electrical products and replaces all previous catalogues.

Specify Superlux for Your Peace of Mind!

You can specify Superlux Lighting and Electrical products with confidence.

Guaranteed quality and a wide range of choice has been the key to the success of Superlux for over half a century, and the company is committed to the evolving field of lighting.

The Superlux difference, many of the products in this catalogue are designed and manufactured by Superlux. We are excited to produce products which are innovative and designed with benefits such as easier installation and superior performance for our Australian and New Zealand customers. We are not reliant on local production alone and search the world for the best and most Up-to-date manufacturing facilities.

From our Sydney warehousing facility we offer a comprehensive choice of quality lighting products from Australasia and around the world.

1. FULL TERMS & CONDITIONS OF SALE

are available on request.

2. GENERAL

Goods are sold on the condition that the reseller is familiar with the technical information contained in this catalogue, relevant electrical codes of practice, wiring rules and is suitably knowledgeable with this type of lighting to make the correct product choice.

3. RECEIPT OF GOODS

Superlux Pty Limited is responsible for goods only up until they are received into your care. It is important that any external damage to packaging is recorded on the courier documentation when signing. It will be the responsibility of the customer to check deliveries for damages and notify the company within 48 hours of any damage caused by delivery for the company to make claims against the carrier. Non-delivery – any shipments that fail to arrive or have items missing must be reported within 5 working days. Once goods have left your store no claims for missing goods can be accepted.

4. CUTTING OF HOLES

For reasons beyond our control, specifications may change

without notice. As such, the cutting of holes or other installation / constructional work prior to receiving product is entirely at the purchaser's risk.

5. SPLIT DELIVERIES

For reasons beyond our control, specifications may change regularly. As such, split deliveries run the risk of model changes and / or supply issues and are entirely at the purchaser's risk.

6. GUARANTEE

We put considerable effort into ensuring our products are made to meet or exceed the relevant standards. Should a product fail due to defects in materials or workmanship, we will either repair or replace it at our discretion. If this is not possible then we will offer an alternative product as replacement. The guarantee does not cover products damaged due to wrong selection, misuse or incorrect installation. The guarantee period is normally 12-months from despatch; however, on some products this may be extended. Superlux Pty Limited accepts no claims for indirect or consequential damages whether based on contract, tort or any other legal theory.

E & OE: Errors and Omissions Excepted.

Declaration of Compliance with Standards

Superlux is committed to the electrical safety of all products sold, and in addition to our in-house engineering facilities we utilise the independent services of Laboratories to verify product compliance.

Where required by Australian and New Zealand regulations, our products also have necessary regulatory approvals and/or declarations.

superlux
we engineer light

SWIT
NOT

Contents

Task Lighting



2-9

Downlights



10-29

Pathway & Step Lights



30-37

Furniture and Display Lights



38-47

Striplights



48-57

Spotlights



58-65

Track Lights



66-69

Ceiling & Wall Lights



70-85

Decorative Lights



86-99

Exterior Bulkheads



100-107

Lanterns, Bollards



108-119

Flood and Area Lighting



120-127

Sensors, Transformers & Electrical Trade Products



128-131

Bulbs and Tubes



132-138

Index

PRODUCT	PAGE
720-22	96
720-32	96
720-32QF	96
720-40	96
142-144	

Equipoise™

- Superlux Equipoise Lamps, famous for their timeless styling and precision engineering
- Shade switches are incorporated in all Equipoise models • Available in Silver, Black or White
- Approval number NSW20623

LED
GLSD-6BWW



- 75 lm/W • 450 total lm • Dimmable
- 6Watts • 3,000K • CRI>81 • 270° Beam

FLUORESCENT
SBFBA-11BWW



- 60 lm/W • 660 total lm
- 11Watts • 2,700K • CRI>80



MAX. 100W

AS-NZ Approved

LSB

Large size Equipoise, 1065mm reach.
Comes complete with G clamp base.
Maximum clamping width 58mm.
Extra Base Options:

LSM - 1, 3, 4, 5, 7, 8, 9, 11, 12, 14, 15, 16.

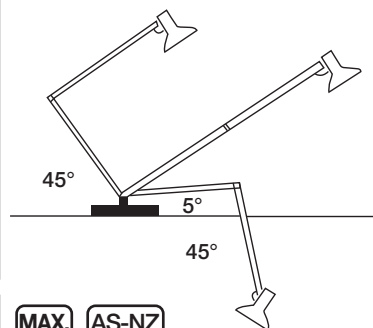

MAX. 100W

AS-NZ Approved

LSA

Medium size Equipoise, 800mm reach.
Comes complete with heavy table base. Extra Base Options:

LSM - 1, 2, 3, 4, 5, 8, 9, 11, 12, 14

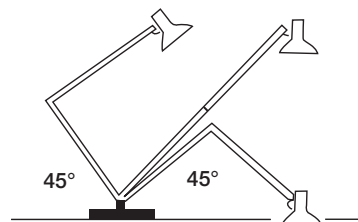

MAX. 75W

AS-NZ Approved

LSC

Small size Equipoise 600mm reach,
Supplied complete with heavy table base.
Extra Base Options:

1, 2, 3, 4, 5, 8, 9

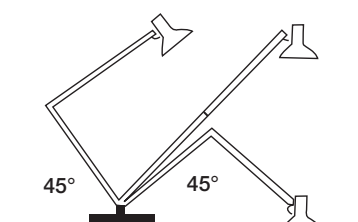

Equipoise™ Base Fittings



LSM-1

Swivel G-clamp for inclined surfaces and vertical edges (for example, drawing boards)

LSM-2

Plain G-clamp for clamping onto horizontal surfaces only.

LSM-3H

Extra heavy duty wall bracket

LSM-4

Bracket for horizontal surfaces.

LSM-5

Swivel bracket with mounting stud and nut.

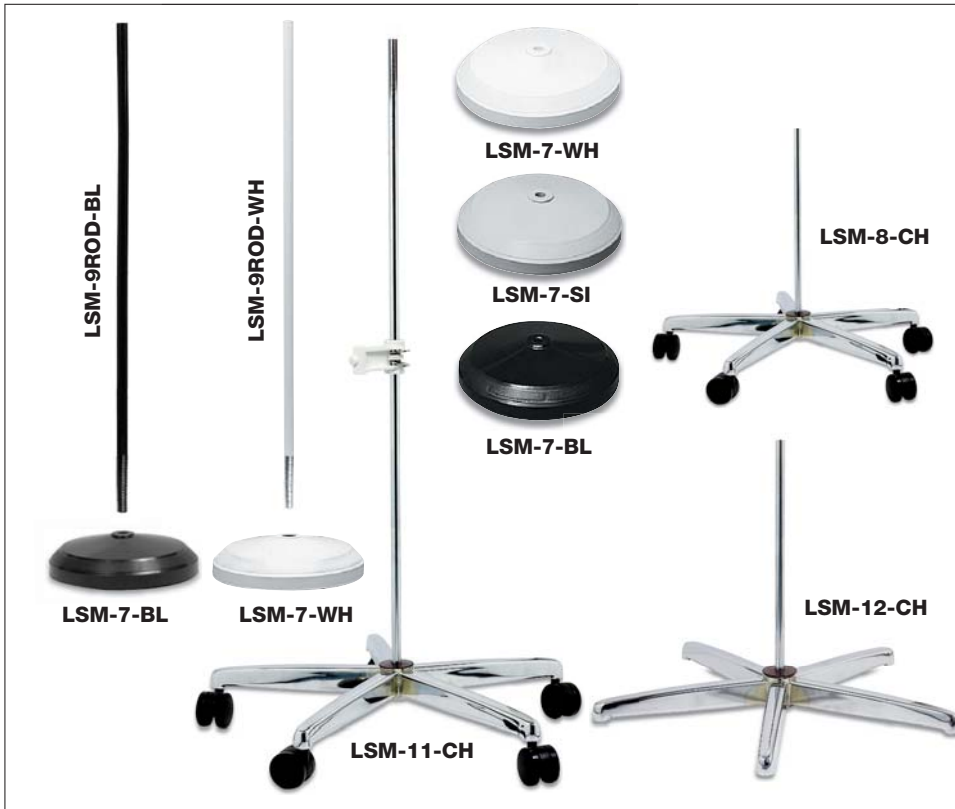

LSM-7

Heavy table base. 220mmØ

LSM-8-CH

Five castor floor stand. Overall height 700mm.

LSM-9ROD

Low cost solution to floor mounting when fitted to LSM-7, LSA, LSB, LSC, LSV and FL models. 220mmØ x 730mmH

LSM-11

Five castor overall height 1220mm and quick release adjustable height bracket, 660mmØ base

LSM-12

Floor stand with 300mm rod, overall height 340mm, 660mmØ base suitable for MODEL LSZ and LSX lamps.

Task lighting and base compatibility

LSM	1	2	3H	4	5	6	7	8	9	11	12	14	15	16
LSB	✓	✓	✓	✓	✓		✓	✓	✓	✓	✓	✓	✓	✓
LSA	✓	✓	✓	✓	✓			✓	✓	✓	✓	✓	✓	✓
LSC		✓		✓				✓	✓					
FL		✓	✓	✓			✓	✓	✓	✓	✓			
LSV		✓	✓	✓		✓		✓	✓	✓	✓			
LSX		✓	✓	✓							✓			
LSZ		✓	✓	✓							✓			
LSH		✓	✓	✓						✓		✓	✓	✓
LSD		✓	✓	✓						✓		✓	✓	✓
LSP		✓	✓	✓						✓		✓	✓	✓
LSS		✓	✓	✓						✓		✓	✓	✓
LSN		✓	✓	✓						✓		✓	✓	✓

FLUORESCENT
2 x PL-9CW *Included*



- 68 lm/W • 612 total lm
- 9Watts • 4,000K • CRI>82

DESK LAMPS



FL -WH

FL-BL

- AS-NZ Approved
- EEl Complies
- 18W

FL

- 860mm reach
- Comes complete with G clamp base
- Full range of base fittings available.
- Approval number - N20071

ACCESSORIES



FL-Louvre

FL-Louvre
Optional Louvre to reduce glare

FLOOR STAND



FLF-BL

- AS-NZ Approved
- EEl Complies
- 18W

FLF-BL

- Floor stand
- 1500mm height.
- Approval number - N20071

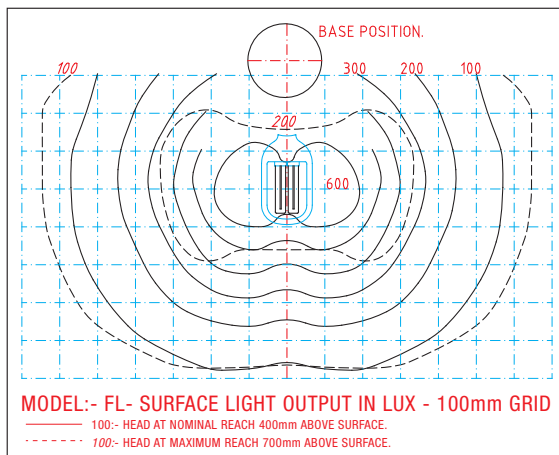

• Fluorescent

G10q

FLUORESCENT
GIR-22-TP
Included



• **55 lm/W** • 1210 total lm
• 22Watts • 5,000K • CRI>75

MAGNIFYING EQUIPOISE



LSX White

LSX-LENS



LSX-GLASS



Hinged Lens cover

AS-NZ
Approved

22W

G10q

LSX White - Magnifying Equipoise lamp

- Shadowless
- 1140mm reach
- 22 watt circular Fluorescent
- 120mmØ Lens 3 diopter magnification
- Comes complete with G clamp base
- **Approval number - NSW20623**

LSX-LENS

- Optional lens
- Clicks on, to enclose the lamp

LSX-GLASS

- Optional spare 3 diopter magnification glass only

LUX LEVELS

DISTANCE	LUX
250mm	3,300 lux
400mm	1,215 lux
700mm	425 lux

MAGNIFYING EQUIPOISE



LSZ White



removable lens cover supplied

BASE OPTIONS



LSM 12-CH
Heavy Base

LSX and LSZ
Base options
3H, 4, 5, 12.
White.

AS-NZ
Approved

27W

G23

LSZ White - Magnifying Equipoise lamp

- Switchable light settings 9w, 18w and 27w
- 3 x 9watt PL shadowless light source
- G clamp base supplied with fitting
- 960mm reach
- 160 x 105mm Large 3 Diopter rectangular lens
- Lens mounted on swivel for precision focusing
- **Approval number - NSW20623**

G23

FLUORESCENT
3 x PL-9CW **Included**



• **68 lm/W** • 612 total lm
• 9Watts • 4,000K • CRI>82

Clinical Equipoise™ Lamp

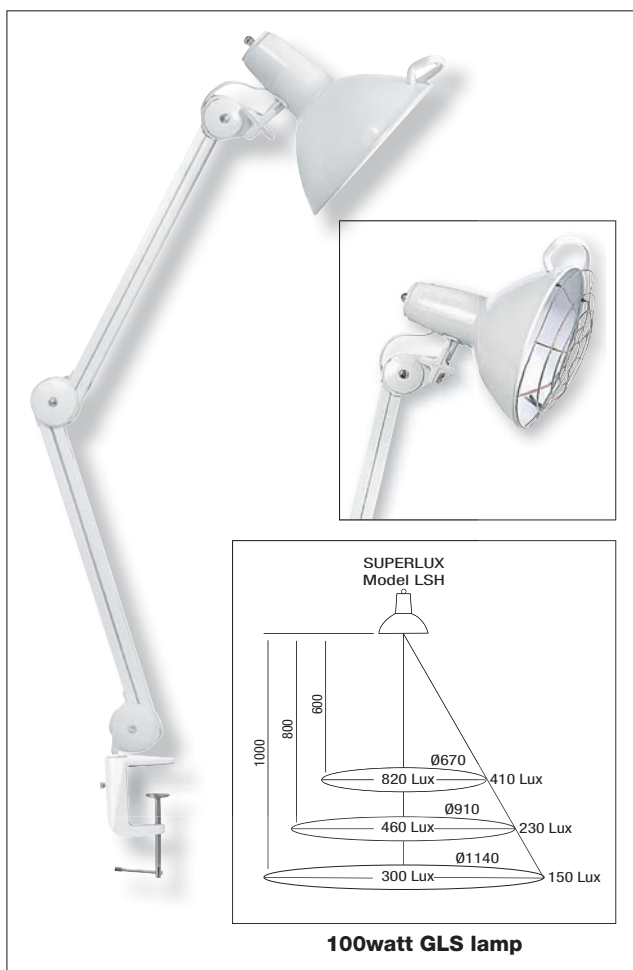

HEAT LAMP
MAX 175mmL
Medical Philips Infraphil
PAR38 Red front 150watt

MAX. 275W

E27

MAX. 100W R80, PAR38

LSH

- 980mm reach
- In-line cord switch
- Concealed balancing springs
- Supplied with G-clamp base.

Safety features:

- Guard for heat lamp included
- Shade handle for safe handling
- Extra internal heat shield, cooler shade
- Commonly connected from a wall switch
- Approval number - N20623
- Limited movement not suitable for mounting high up on wall or in high use areas

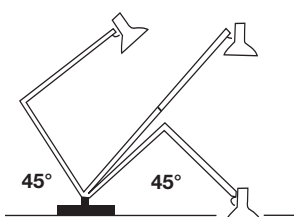

LED
PAR38-12WLED-WH

- 80 lm/W • 960 total lm
- 12Watts • 3,000K • CRI>80 • 63° Beam

LED
GLSC-6EWW

- 100 lm/W • 600 total lm
- 6Watts • 3,000K • CRI>81 • 270° Beam

LED
R80-10EWW

- 70 lm/W • 700 total lm
- 10Watts • 3,000K • CRI>81 • 120° Beam

Temporary Lighting System

10x MAX. 75W IP 23

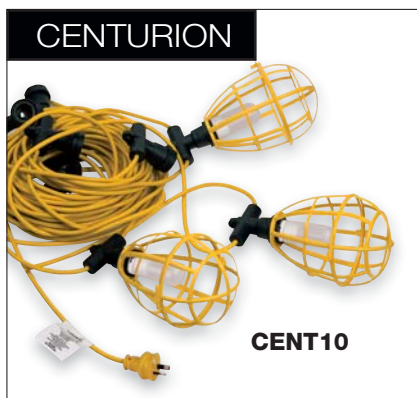

CENT10

- Durable bright yellow round cable reduces possibility of accidents.
- 30metre overall length.
- Lamp holders permanently moulded onto cable 3 meters apart.
- Rigid mount eyelets for hooks or wire to make hanging easy
- Reusable - can be arranged to easily suit most working situations.
- For indoor and outdoor use, construction sites, parking lots, walkways, wooded areas - wherever temporary lighting is required.
- To comply with AS/NZS3012 the Centurion must be mounted at least 2.5 metres from the floor/ground/ platform unless mounted directly below ceiling.
- The patented cage snaps on fitting to enable quick assembly.
- A secure closure clasp on cage makes changing bulbs easy.
- Use 75 watt incandescent, 100 watt halogen double envelope as pictured above HDE100-E27 or the self ballasted lamps shown.
- Approval number - NSW22910

CENT10-CAGE

- Replacement cages can be purchased separately



LED
GLSD-6EWW

- 75 lm/W • 450 total lm • Dimmable
- 6Watts • 3,000K • CRI>81 • 270° Beam

HALOGEN
HDE150-E27

- 15 lm/W • 2250 total lm • Dimmable
- 150Watts • 3,000K • CRI>100

FLUORESCENT
SBF80-13EWW

- 60 lm/W • 780 total lm
- 13Watts • 2,700K • CRI>80 • 70° Beam

Designer Desk Lamps

LED DESK LAMP



INTEGRAL



• **60 lm/W** • 360 total lm
• 6Watts • 4,000K • CRI>80 • 40° Beam



TLED24

LED Counter balanced lamp

- Long life LED energy saving
- Available in polished Chrome or Black Chrome
- Unique design acrylic head
- Cool running comfortable safe light
- 500mmH Maximum
- 125mmØ base
- 85mmØ head
- Safe extra low voltage power supply
- 500lux illuminance at 400mmH
- Switch at base

Close up of LED's & Unique Acrylic Head



Dimmable LED Desk Lamps

- Touch switch dimmable – 3 light levels
- Integral 6Watt LED lamp similar to 50Watt Halogen light effect
- Complete with heavy base and plug-in extra low voltage power supply

LED DESK LAMPS



INTEGRAL



• **80 lm/W** • 480 total lm • Dimmable
• 6Watts • 5,700K • CRI>80 • 65° Beam

TLED84-BLSI

- Maximum height 540mmH
- Lamp base 220mmL x 130mmW
- Lamp head is tiltable up and down and side to side.
- Lamp stem moves through 90°

INTEGRAL



• **80 lm/W** • 480 total lm • Dimmable
• 6Watts • 5,700K • CRI>80 • 65° Beam

TLED85-WHSI

- Maximum height 600mmH
- Lamp base 210mmL x 170mmW
- Lamp head is tiltable up and down
- Lamp stem moves through 90°

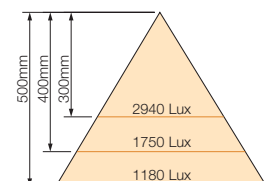

NIGHT LIGHT EQUIPOISE



MAX.
60W

E27

Main Shade



Made
in NZ



MAX.
20W

E14

Night Light



LSN-WH

Clinical Equipoise with Night Light

- Construction allows individual switching of E27 and E14 lamp holders at wall
- Supplied in White paint finish
- Constructed with clinical frame, which allows maximum downward movement when mounted on wall or ceiling brackets
- Equipoise Clinical lamps may be used on base options

LSM 2, 3H, 4, 11, 14, 15, 16

- Shade 135mmØ
- 1065mm reach
- For safety reasons do not install lamps in position where they come in contact with a flammable material

Clinical Equipoise™ Accessories



LSM-14

Wall bracket, adjustable
560mm height movement.
Quick release
sliding bracket



Example:
Model LSS
mounted on
LSM-16

Photo Courtesy of
The Intensive Care
Unit, Waikato Hospital
Hamilton



LSM-3H

Extra heavy duty wall bracket

LSM-15

180° Wall mount extension arm 410mm

LSM-16

Ceiling mount, 360° overhead mount with extension.
440mmL x 630mmH

Clinical Equipoise™ Lamps



230V-240V



Made in NZ

- Products on this page supplied in white paint finish
- All models are constructed with clinical frames, which allow maximum downward movement when mounted on wall or ceiling brackets
- For safety reasons do not install lamps in a position where they come in contact with a flammable material

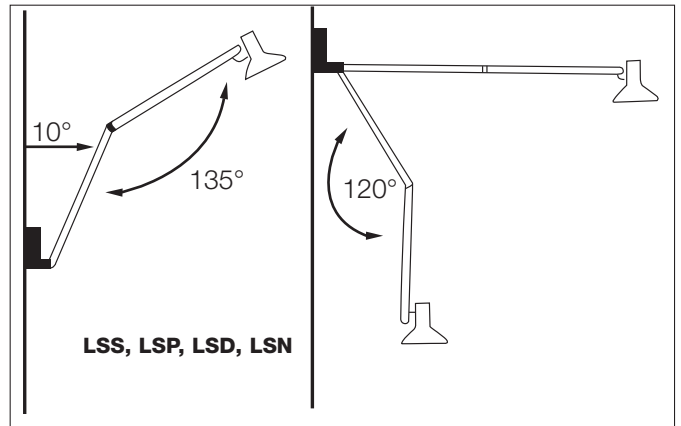

MAX. 100W

B22

LSD

- Equipoise shade 188mmØ
- Base options: LSM-2, 3H, 4, 11, 15, 16

MAX. 150W

PAR 38

MAX. 100W

GLS

E27

LSP

- Suits PAR 38 lamps.
- Shade 135mmØ
- 1065mm reach
- Base options: LSM-2, 3H, 4, 11, 12, 14, 15, 16

0.5m Beam

Lamp Included

GU 10

MAX. 50W

LSS

Halogen Inspection Lamp

- 50w 240 volts, dichroic bulb.
- Shade 108mmØ
- Base options: LSM-2, 3H, 4, 11, 14, 15, 16

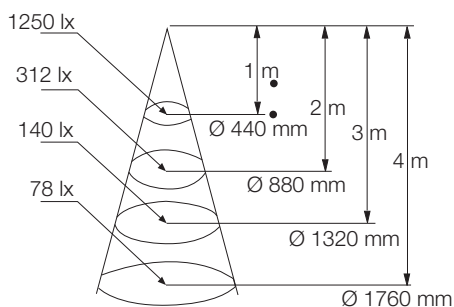

Diffuser Optimised Downlights

- Samsung brand LED technology
- Enclosed body retains buildings thermal envelope
- Diffuser designed to give uniform light spread
- Forward traveling heat sinking to dissipate heat below the ceiling to ensure optimum light output and life of LED light source.
- Integral driver for easy installation, no need to mix and match components at your own peril.



Easy looping terminal block



12 WATT

Multi Dimmable

LDL125-WH

INTEGRAL LED

- **75 lm/W** • 900 total lm • Dimmable
- 12Watts • 3,000K • CRI>81 • 60° Beam

LDL125-WH

- Flange size 148mmØ
- Light effect of a 100Watt incandescent downlight
- Dimmable down to 30% of full brightness

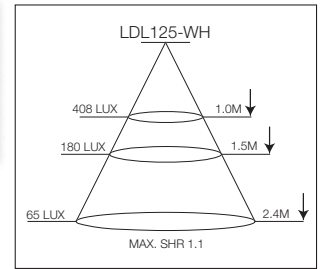

8 WATT

Dimmable

LDL100-CH **LDL100-WH**

INTEGRAL LED

- **75 lm/W** • 600 total lm • Dimmable
- 8Watts • 3,000K • CRI>81 • 60° Beam

LDL100

- Flange size 125mmØ
- Light effect of a 75Watt incandescent downlight

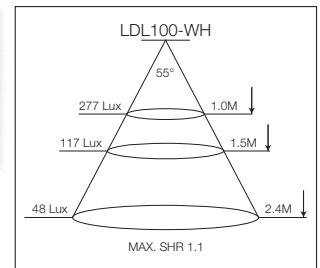

4.5 WATT

LDL90-WH

INTEGRAL LED

- **80 lm/W** • 362 total lm
- 4.5Watts • 3,000K • CRI>81 • 60° Beam

LDL90-WH

- Flange size 111mmØ
- Light effect of a 60Watt incandescent downlight

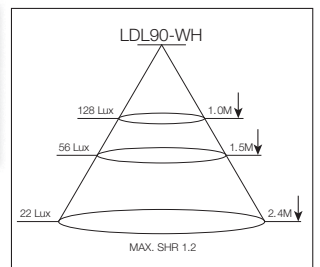

3.5 WATT

LDL80-WH

INTEGRAL LED

- **80 lm/W** • 277 total lm
- 3.5Watts • 3,000K • CRI>81 • 60° Beam

LDL80-WH

- Flange size 102mmØ
- Light effect of a 35Watt incandescent downlight

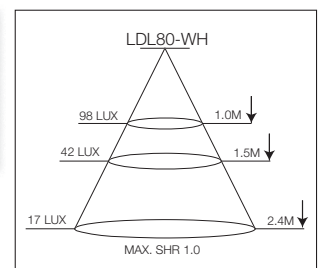

MODEL	CLASS	AIR / MOISTURE TRANSFER	INSULATION	F		CAVITY DEPTH	SIDE CLEARANCE
LDL125	IC	Closed	cover over -non flammable	Yes	125mm	180mm	25mm
LDL100	IC	Closed	cover over -non flammable	Yes	100mm	180mm	25mm
LDL90	IC	Closed	cover over -non flammable	Yes	90mm	180mm	25mm
LDL80	IC	Closed	cover over -non flammable	Yes	80mm	180mm	25mm

Diffuser Optimised Downlights

- Samsung brand LED technology
- Enclosed body retains buildings thermal envelope
- Diffuser designed to give uniform light spread
- Forward traveling heat sinking to dissipate heat below the ceiling to ensure optimum light output and life of LED light source.
- Integral driver for easy installation, no need to mix and match components at your own peril.



Easy looping terminal block



15 WATT

LDL160-WH

INTEGRAL LED

- **85 lm/W** • 1275 total lm
- 15Watts • 3,000K • CRI>81 • 60° Beam

- LDL160-WH**
- Flange size 180mmØ
 - Light effect of a 180Watt incandescent downlight

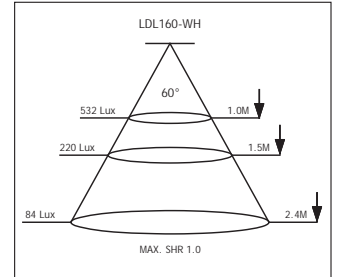

18 WATT

LDL175-WH

INTEGRAL LED

- **86 lm/W** • 1560 total lm
- 18Watts • 4,000K • CRI>81 • 60° Beam

- LDL175-WH**
- Flange size 198mmØ
 - Light effect of a 2 x 18W CFL downlight

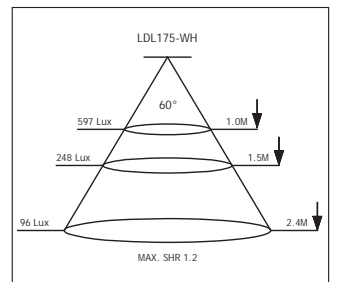

25 WATT

LDL210-WH

Ideal Double Fluro Replacement

INTEGRAL LED

- **80 lm/W** • 2200 total lm
- 25Watts • 4,000K • CRI>81 • 60° Beam

- LDL210-WH**
- Flange size 234mmØ
 - Light effect of a 2 x 26W CFL downlight

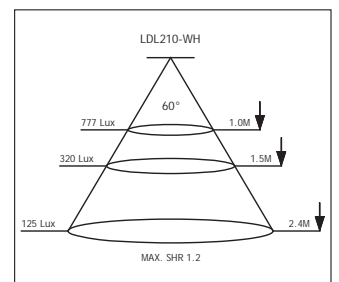

MODEL	CLASS	AIR / MOISTURE TRANSFER	INSULATION	F		CAVITY DEPTH	SIDE CLEARANCE
LDL160	CA80	Closed	Side Abutted	Yes	160mm	180mm	20mm
LDL175	CA80	Closed	Side Abutted	Yes	175mm	180mm	20mm
LDL210	CA80	Closed	Side Abutted	Yes	210mm	180mm	20mm

LED Frame Lights

NEW

TRUE IC



230V-240V



- Recessed Gimble Frame Lights • Integral 6.5W LED module similar light output to a 50 watt halogen downlight
- Full metal case provides forward heat-sinking and closed IC rating • Integral driver



LDL-GIM1-SI



LDL-GIM3-SI



LDL-GIM2-SI



LDL-GIM4-SI

INTEGRAL



- **83 lm/W** • 540 total lm
- 6.5Watts • 3,000K • CRI>80 • 30° Beam

LDL-GIM1

- Flange 110mm Sq

INTEGRAL



- **83 lm/W** • 1080 total lm
- 2x 6.5Watts • 3,000K • CRI>80 • 30° Beam

LDL-GIM2

- Flange 203mmL x 110mmW

INTEGRAL



- **83 lm/W** • 1620 total lm
- 3x 6.5Watts • 3,000K • CRI>80 • 30° Beam

LDL-GIM3

- Flange 300mmL x 110mmW

INTEGRAL



- **83 lm/W** • 2160 total lm
- 4x 6.5Watts • 3,000K • CRI>80 • 30° Beam

LDL-GIM4

- Flange 210mm Sq



LDL-GIM1-WH



LDL-GIM3-WH



LDL-GIM2-WH



LDL-GIM4-WH

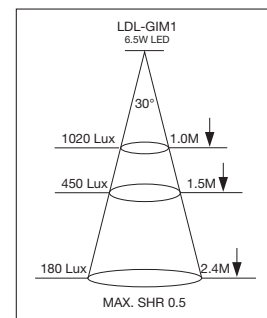

**30 degrees
half light beam angle**

MODEL	CLASS	AIR / MOISTURE TRANSFER	INSULATION	F		CAVITY DEPTH	SIDE CLEARANCE
LDL-GIM1	IC	Closed	cover over -non flammable	Yes	95mm x 95mm	150mm	20mm
LDL-GIM2	IC	Closed	cover over -non flammable	Yes	95mm x 190mm	150mm	20mm
LDL-GIM3	IC	Closed	cover over -non flammable	Yes	95mm x 285mm	150mm	20mm
LDL-GIM4	IC	Closed	cover over -non flammable	Yes	195mm x 195mm	150mm	20mm

Aimable & Surface Downlights

AIMABLE



LDLX100-WH

NEW

INTEGRAL



- **43 lm/W** • 387 total lm
- 9Watts • 3,000K • CRI>80 • 25° Beam

CA
80°C

IP
20



230V-240V

LDLX100-WH

- Tiltable LED Darklighter
- Perfect for washing walls with light and highlighting features or artworks
- With lens to prevent air transfer from ceiling cavity
- Flange 110mmØ
- Supplied assembled with driver
- 387 total lumens output through front aperture of downlight

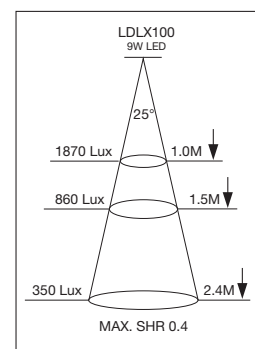

SURFACE MOUNT



LDLS130-WH

INTEGRAL



- **66 lm/W** • 860 total lm
- 13Watts • 3,000K • CRI>80 • 60° Beam

IP
20

230V-240V

LDLS130-WH

- Integral 13 watt LED Surface Mount Downlight
- Driver included in base
- 130mmØ x 90mmH
- Ideal for where downlights are required on fire rated ceilings

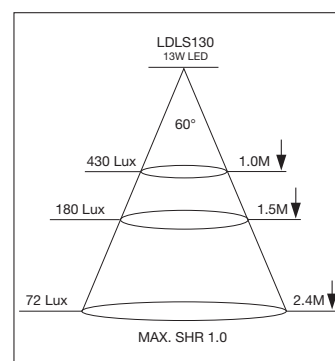

MODEL	CLASS	AIR / MOISTURE TRANSFER	INSULATION	F		CAVITY DEPTH	SIDE CLEARANCE
LDLX-100	CA80	Closed	Side Abutted	Yes		100mm	150mm

LED Commercial Downlights

NEW

WATERPROOF DOWNLIGHT



LDL-IP55-WH

INTEGRAL



- **77 lm/W** • 1080 total lm
- 14Watts • 3,000K • CRI>80 • 38° Beam



LDL-IP55-WH

- Ideal for wet areas such as in bathrooms, laundries and under eaves

SURFACE DOWNLIGHT/SPOTLIGHT



SCD25-TLT-SI



SCD25-TLT-WH



SCD25-TLT-SI



SCD25-TLT-WH

INTEGRAL



- **88 lm/W** • 2,210 total lm
- 25Watts • 4,200K • CRI>85 • 30° Beam



SCD25-TLT

- 25Watt integral LED
- 109mmH x 131mmØ
- Use as surface mounted downlight or as a spotlight
- Ideal for use on angled ceilings where downlighting is required
- 30 degree beam angle with spill light out to 60 degrees
- Integral driver in base

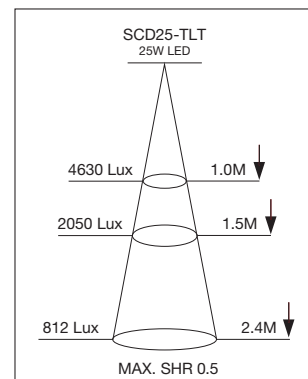

MODEL	CLASS	AIR / MOISTURE TRANSFER	INSULATION	F	Icon	CAVITY DEPTH	SIDE CLEARANCE
SRD48-TLT	CA135	Closed	Side Abutted	Yes	230mm x 130mm	230mm	75mm
LDL-IP55	CA135	Closed	Side Abutted	Yes	80mm	120mm	25mm

Wet Area Downlights

LED IP54



LDL-IP54-SI

LDL-IP54-WH

INTEGRAL



- 83 lm/W • 540 total lm
- 6.5Watts • 3,000K • CRI>81 • 50° Beam



LDL-IP54

- 6.5Watt integral LED, Similar light output to a 50 watt halogen
- 81mmØ Overall
- Supplied with LED driver, simply wire direct to mains
- Ideal for use in wet areas

MR16 IP65



SV-IP65-WH

SV-IP65-SC



SV-IP65

- 85mmØ overall
- Ideal for use in wet areas
- Electronic transformer with lamp holder assembly with thermal cut off included

MR16

HALOGEN

MRE16-35-D38
Included



- 15 lm/W • 525 total lm • Dimmable
- 35Watts • 3,000K • CRI>100 • 38° Beam

LED

MR16-HPLED-WH



- 80 lm/W • 480 total lm
- 6Watts • 3,000K • CRI>80 • 38° Beam

EAVE LIGHT IP55

SV-IP55-SS



SV-IP55-SS

- 316 Stainless Steel Trim
- 105mmØ overall
- Ideal for under eave or in wet areas
- Purchase SVE-T60 transformer separately
- Flange sits proud of eave by 25mm

LED
GU10D-5LED-WW
Included



- 68 lm/W • 340 total lm • Dimmable
- 5Watts • 3,000K • CRI>80 • 30° Beam

Lens Optimised Downlight

LED 5 WATT

Dimmable



LDLB70-SC



LDLB70-WH



LDLB70-BL



LDLB70

- Affordable dimmable energy efficient LED downlight
- 5 watt equivalent to 35 watt halogen
- Fixed downlight
- Downlight body shaped to prevent fitting of halogen lamps

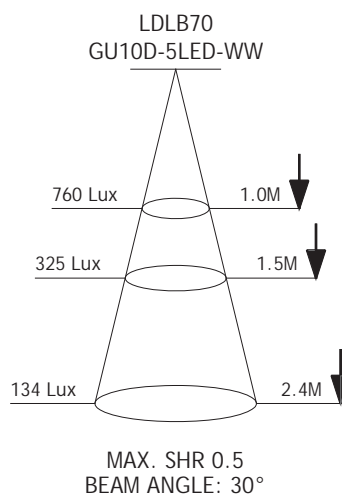
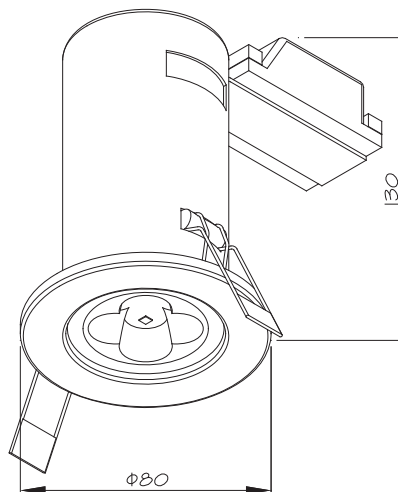

MODEL	CLASS	AIR / MOISTURE TRANSFER	INSULATION			CAVITY DEPTH	SIDE CLEARANCE
LDLB70	IC	Closed	Cover over - non flammable	Yes	70mm	150mm	25mm

LED
MR16-HPLED-WH
Included



• 80 lm/W • 480 total lm
• 6Watts • 3,000K • CRI>80 • 38° Beam

Reflector Optimised Downlight

LED 6 WATT

LED
Now 6W
480 lm



LDLB90-WH



LDLB90-SC



LDLB90-GD



LDLB90

- 6watt LED bulb comparable to 35watt halogen downlight
- Reflector bulb designed to give uniform light spread
- Integral driver for easy installation
- Aluminium die cast face
- Both lamp and downlight have heat sink technology for effective thermal management
- Japanese manufactured LED
- 5 year transformer warranty
- Acoustic rating: for acoustic STC55 Ceilings space 1.6m minimum. For acoustic (RW) STC57 and 58, space 2.5m minimum.

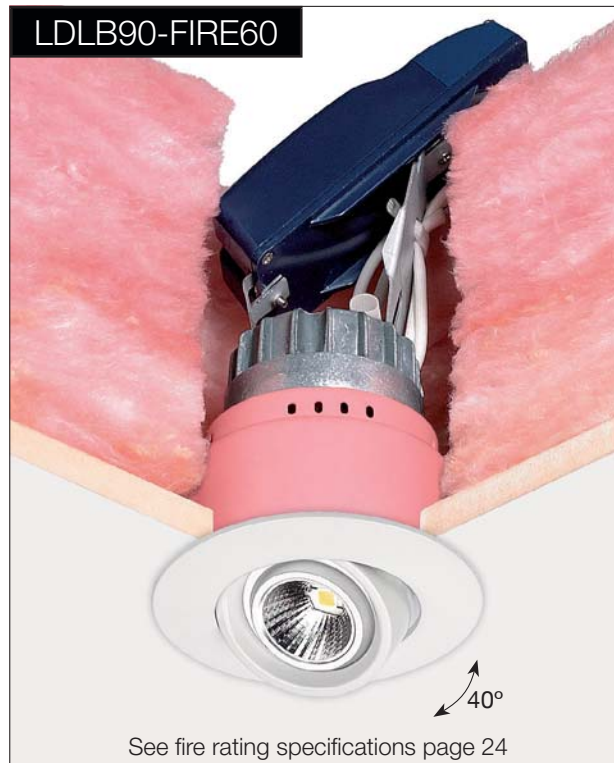
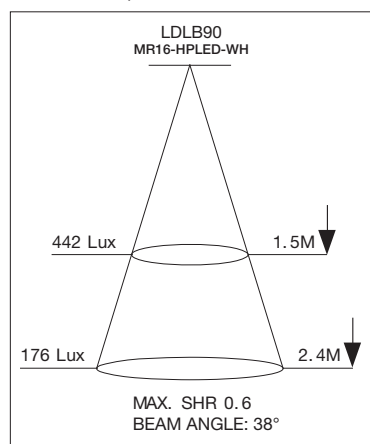

LDLB90-FIRE60

See fire rating specifications page 24

MODEL	CLASS	AIR / MOISTURE TRANSFER	INSULATION			CAVITY DEPTH	SIDE CLEARANCE
LDLB90	CA135	Closed	Side Abutted	Yes	90mm	210mm	50mm

Reflector Downlight

SD130



SD130-WH



SD130-SC



SD130

Multi purpose high quality reflector downlight with three separate uses

- PAR30 Lamp
- GLS/LED Lamp
- Double envelope Halogen
- High quality long life reflector
- Low profile white or Satin Chrome trim
- Patented aluminum Die Cast heat sink on lamp holder

LED GLSD-6EWW



- 75 lm/W • 450 total lm • Dimmable
- 6Watts • 3,000K • CRI>81 • 270° Beam

FLUORESCENT SBF30-15ECW



- 60 lm/W • 900 total lm
- 15Watts • 4,000K • CRI>80 • 74° Beam

HALOGEN HDE100-E27



- 15 lm/W • 1500 total lm • Dimmable
- 100Watts • 3,000K • CRI>100

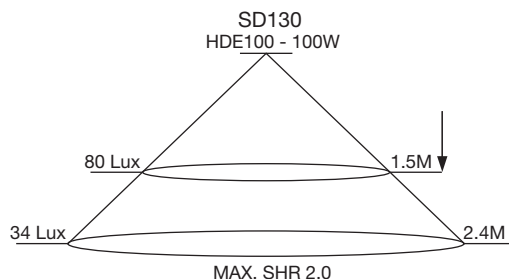
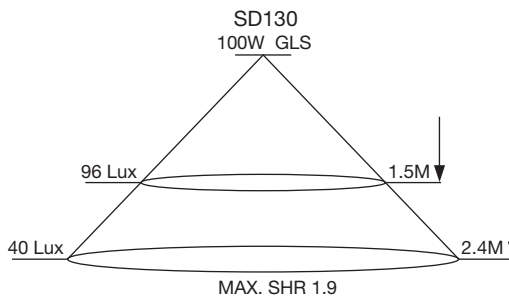
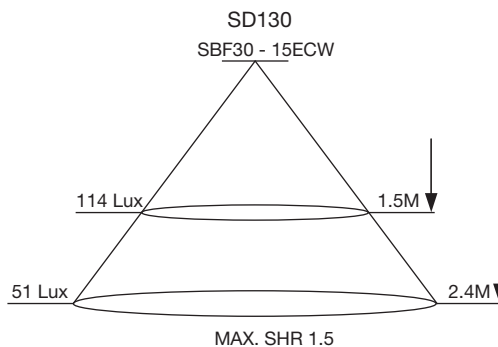

MODEL	CLASS	AIR / MOISTURE TRANSFER	INSULATION	F		CAVITY DEPTH	SIDE CLEARANCE	
SD130	CA135	Closed	Side Abutted	Yes		127mm - 130mm	220mm	50mm

Multi Purpose Reflector Downlight



Multi purpose high quality reflector downlight with five separate uses

PAR 38
Superlux PAR38-12WLED-WH, PAR38-LED-WH, PAR38-DIM-18WW, PAR38-CRI-18WW

GLS Lamp

Heatlamp

Self ballasted fluorescent
Superlux SBFSP-26EWW 26watt

Double Envelope Halogen
Superlux HDE-150-E27

LED
PAR38-12WLED-WH

- 80 lm/W • 960 total lm
- 12Watts • 3,000K • CRI>80 • 63° Beam

FLUORESCENT
SBFSP-26EWW

- 60 lm/W • 1560 total lm
- 26Watts • 2,700K • CRI>80

HALOGEN
HDE150-E27

- 15 lm/W • 2250 total lm • Dimmable
- 150Watts • 3,000K • CRI>100



SD153

- High quality long life reflector
- Low profile white or Satin Chrome trim
- Patented aluminum Die Cast heat sink on lamp holder

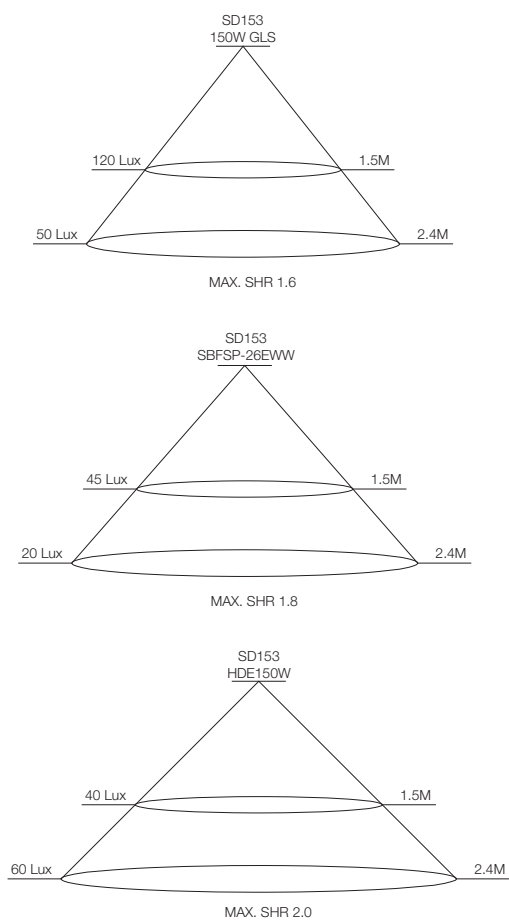

MODEL	CLASS	AIR / MOISTURE TRANSFER	INSULATION	F		CAVITY DEPTH	SIDE CLEARANCE
SD153	CA135	Closed	Side Abutted	Yes	153mm	240mm	50mm

Reflector & Baffled Downlights



LED
GLSD-6EWW



- 75 lm/W • 450 total lm • Dimmable
- 6Watts • 3,000K • CRI>81 • 270° Beam

HALOGEN
HDE100-E27



- 15 lm/W • 1500 total lm • Dimmable
- 100Watts • 3,000K • CRI>100

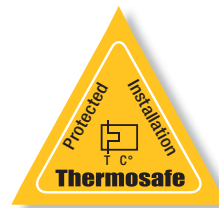

ESPECIALLY DESIGNED FOR YOUR SAFETY AND PEACE OF MIND
LOW GLARE BAFFLED DOWNLIGHT



SD125

- (RW) STC Sound Transmission Ratings
- Lamp not exposed in ceiling cavity
- Thermal cut-off and auto reset function for protection against misuse and overloading.
- Attractive low profile ceiling trim for improved aesthetic appeal.
- 3 mounting clips to ensure optimum snug fit to ceiling.

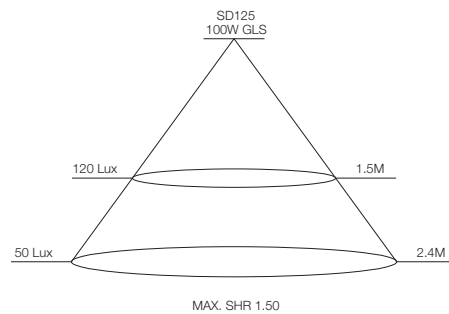
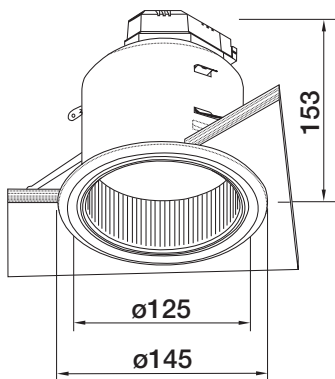

MODEL	CLASS	AIR / MOISTURE TRANSFER	INSULATION	F	Light Bulb Icon	CAVITY DEPTH	SIDE CLEARANCE
SD125	CA135	Closed	Side Abutted	Yes	125mm*	180mm	25mm
*SD125-LFL		Optional Flange			130mm-175mm		

Reflector Optimised Downlight

FLUORESCENT SBFSP-14EWW

Included



- 60 lm/W • 840 total lm
- 14Watts • 2,700K • CRI>80

LED GLSD-6EWW



- 75 lm/W • 450 total lm • Dimmable
- 6Watts • 3,000K • CRI>81 • 270° Beam



SD125F



SD125F-FIRE60



See fire rating specifications page 24



SD125F-WH

SD125F-SC

SD125F-GD

THE ENERGY EFFICIENT DOWNLIGHT
ESPECIALLY DESIGNED FOR
SELF BALLASTED FLUORESCENT LAMPS
15 WATTS EFFICIENCY TAKEN TO AN
EXTREME 100WATTS ILLUMINANCE



SAFE CHANGE OVER



DEDICATED LAMP - GLS lamps will not fit into the SD125F.

DEDICATED REFLECTOR - is designed to optimise self ballasted lamp characteristics.

DEDICATED COMPLETE SOLUTION - eliminates heat transfer inefficiencies in your home.



SD125F

- 14Watt self ballasted lamp included
- Lamp can be safely replaced, just twist out reflector allowing easy and safe access to grasp the back of the lamp .
- Lamp not exposed in ceiling cavity.
- Thermal cut-off and auto reset function for protection against misuse and overloading.

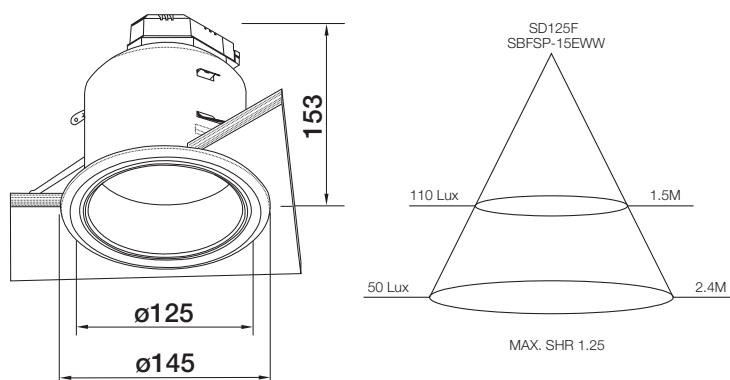

MODEL	CLASS	AIR / MOISTURE TRANSFER	INSULATION	F	Lamp	CAVITY DEPTH	SIDE CLEARANCE
SD125F	CA80	Closed	Side Abutted	Yes	125mm*	180mm	25mm
*SD125LFL		Optional Flange			130mm -175mm		

SD125 Trims Accessories

FLOATING GLASS ACCESSORY



SD-FG-SC
Satin Chrome



SD-FG-WH
White

SD-FG

- Floating glass lens with opaque centre giving a soft, even no-glare light.
- Fits to SD125 and SD125F model downlights
- Your choice of 2 trim colours
- 185mmØ x 30mmH

DIFFUSER



SD125-LFL-WH



SD125-LFL-SC

SD125-LFL

- Retro fit downlight flange
- For use with the SD125F and SD125 to fit holes 130mm-175mm



SD-DIF-SBF

- To fit SD125F downlight model only
- The Diffuser directs some soft light onto the ceiling reducing the cave like effect which downlights can give
- Keeps reflector clean
- Higher illuminance in smaller rooms as more light is reflected sideways



SD-DIF-SBF

Mains Voltage



MODEL	CLASS	AIR / MOISTURE TRANSFER	INSULATION	F		CAVITY DEPTH	SIDE CLEARANCE
SDC-TLT	CA135	Closed	Side Abutted	Yes	80mm*	150mm	50mm
*SDC-LFL	Optional Flange				90mm - 140mm		

HALOGEN
GU10-50-A
Included

- **10 lm/W** • 500 total lm • Dimmable
- 50Watts • 3,000K • CRI>100 • 36° Beam

LED
GU10-HPLED-WH

- **60lm/W** • 300 total lm
- 5Watts • 4,000K • CRI>80 • 30° Beam



SDC-TLT

- 15° Tilt
- 99mm outside Ø
- No transformer required
- Bulb not exposed in cavity
- Quick and easy installation

SDC-LFL

- For use in ceiling hole sizes 90mmØ to 140mmØ.
- Flange overall 163mmØ

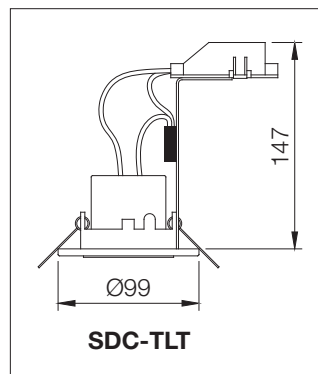

G24d2

FLUORESCENT
PLCD-18CW

- **68 lm/W** • 1224 total lm
- 18Watts • 4,000K • CRI>82



SDFS118-WH

- Surface mount downlight
- White
- High grade aluminium reflector
- Vertical lamp 1x 18w
- Wire wound ballast included
- 150mmØ x 210mmH

Proposed New Recessed Luminaire Standard























AS/NZS60598.2.2

The new AS/NZS60598.2.2 may require all recessed luminaires to be one of 6 new classes. 5 of these classes may be used in residential buildings, and the maximum temperatures of those 5 are reduced to specific temperature limits.

Also significant is that any residential class downlight must be fail safe if accidentally covered with building insulation

Currently there are no fire safety standards for building insulation and the lower downlight temperatures alone can not ensure fire safety. For this reason the downlight manufacturers instructions and products labelling have been improved.

AS/NZS60598.2.2 Downlight class Markings

Current Markings	Proposed Markings	Description	Residential	Commercial
		A Recessed luminaire where building insulation material must not cover or come in contact with any part of the luminaire		
		A Recessed luminaire that can not come in contact with building insulation		
		A closed abutted recessed luminaire where fixed insulating material can be abutted to sides <ul style="list-style-type: none"> • Building Insulation must be non flammable. • Building Insulation must maintain structural integrity at 150 degrees C 		
		A cooler running closed abutted recessed luminaire where fixed insulating material can be abutted to sides <ul style="list-style-type: none"> • Building Insulation must maintain structural integrity at 90 degrees C 		
		Recessed luminaire where fixed building insulation material can abut and cover the recessed luminaire <ul style="list-style-type: none"> • Building Insulation must be non flammable. • Building Insulation must maintain structural integrity at 90 degrees C 		
		Recessed luminaire where fixed building insulation material can abut and cover the recessed luminaire <ul style="list-style-type: none"> • Building Insulation does not have to be non flammable. • Building Insulation must maintain structural integrity at 90 degrees C <p>Important: IC-F Downlights are not to be used in Fire Rated Applications</p>		

60/60/60 Minute Fire Rated Product

The RED intumescent band on the lower section of the downlight and product labelling identify the Superlux 60/60/60 minute fire rated downlight.

Test Specifications

Tested by BRANZ in accordance with AS1530.4.1997, test report No. FP2971. Suitable for floor-ceiling systems Gib_ specification No's GBFC15, GBUC15, GBFC30, GBTP30, GBSC30, GBUC30a, GBUC30b, GBSC60, GBFC60, GBTP60 and GBUC60.

60/60/60 Minutes Approval

- 60 Minutes Stability: To prevent collapse of structural (primary) elements during fire.
- 60 Minutes Integrity: To prevent passage of flame or hot gases through fire separations.
- 60 Minutes Insulation: To prevent the transmission of heat to other firecells or adjacent property.

(RW)STC Sound Transmission Class

- Acoustic ratings STC 55, 57 and 58
- For acoustic STC 55 ceilings, space 1.6m minimum
- For acoustic STC 57 and 58 ceilings, space 2.5m minimum

Installation Notes

- For use in 60 minutes Floor Ceiling systems (also usable for 15 minutes and 30 minutes)
- Only install one fitting in each unsupported section of ceiling lining between timber framing
- Cut hole not closer than 50mm to timber
- Apply bead of **SD-MASTIC** to flange so as to fill hole gap

Product Certification Warning

BRANZ Fire Tests FP2208, FP2918, FP2998 and FP2971 were conducted exclusively with Superlux manufactured product.

MR16 Reflector Downlight Kits

- Electronic transformer with lamp holder assembly

ADJUSTABLE TILT DARKLIGHTERS



SVE-SDL-SS
316 Stainless Steel Flange



SVE-SDL-WH



SVE-SDL

- 95mm sq
- Hole 86-90mmØ



Easy to install
Fits in round holes

HALOGEN
MRE16-35-D38
Included

- 15lm/W • 525 total lm • Dimmable
- 35Watts • 3,000K • CRI>100 • 38° Beam

LED
MR16-HPLED-WH

- 80lm/W • 480 total lm
- 6Watts • 3,000K • CRI>80 • 38° Beam

SWING DOWN AND ROTATABLE



SV-SWGD-CH
CHROME



SV-SWGD-WH
WHITE



SV-SWGD-GD
GOLD



SV-SWGD

- Can be tilted to 75° and rotated 360° to any position
- 130mmØ overall
- Ceiling hole 110mmØ

LARGE FLANGE TILT

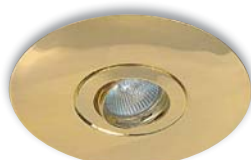

SV-TLTL-GD



SV-TLTL-WH



SV-TLTL-SC



SV-TLTL

TILT - For use in ceiling hole size 95mmØ to 160mmØ.
Flange overall 186mmØ

316 STAINLESS TILTABLE



SVE-TLT-SS



SVE-TLT-SS

- Overall 80mmØ
- Hole 66 to 70mmØ

Integral Design Tiltable Downlight

HIH HALOGEN
MRE16-35-D38
Included

- 15 lm/W • 525 total lm • Dimmable
- 35Watts • 3,000K • CRI>100 • 38° Beam

LED
MR16-HPLED-WH

- 80 lm/W • 480 total lm
- 6Watts • 3,000K • CRI>80 • 38° Beam

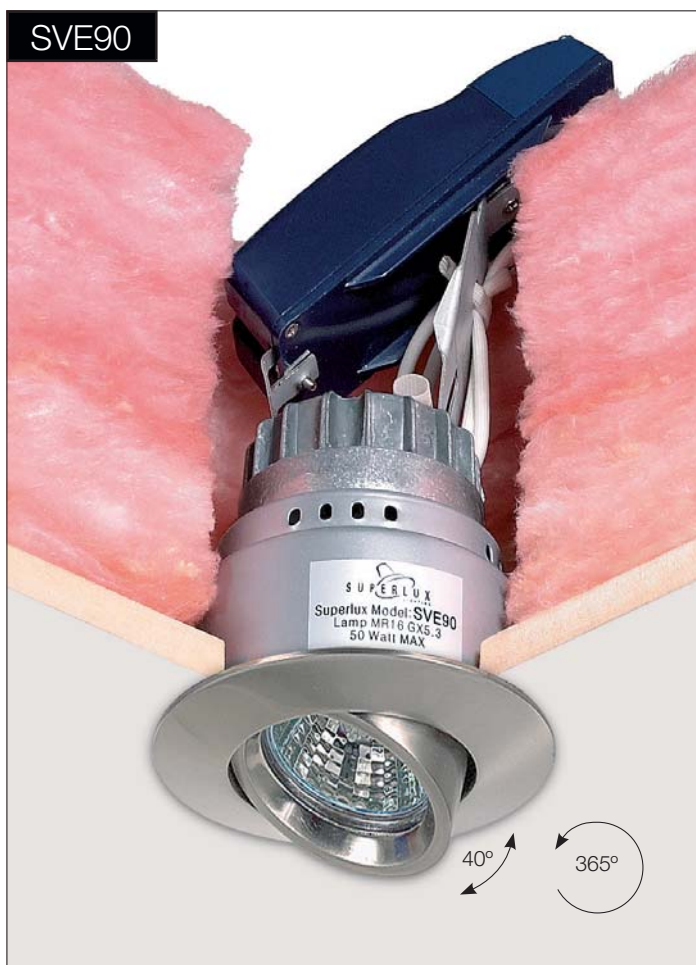

ENGINEERED FOR FIRE SAFETY FOR YOUR PEACE OF MIND



SVE90

- 40° angular adjustment and fully rotatable
- Thermal cut-off protection with auto reset function. Guards against installation faults or overlampping
- 30 minute fire rating
- Quick and economical installation - only one connection - large looping mains terminals
- Integrated downlight for safer placement of transformer and supply wires.
- Acoustic rating: for acoustic STC55 Ceilings space 1.6m minimum. For acoustic (RW) STC57 and 58, space 2.5m minimum.
- Input capacitance 100 nano farrods
- Cos Φ = 0.98 (NSW 21045)
- Superlux recommend use of trailing edge dimmers.
- HIH (High Intensity Halogen) lamp included, 30% power saving 35W = 50W of illuminance
- 5 year transformer warranty
- ECG must not be installed on a circuit with inductive loads

Your choice of colour trims

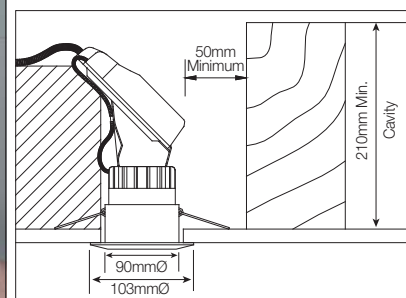
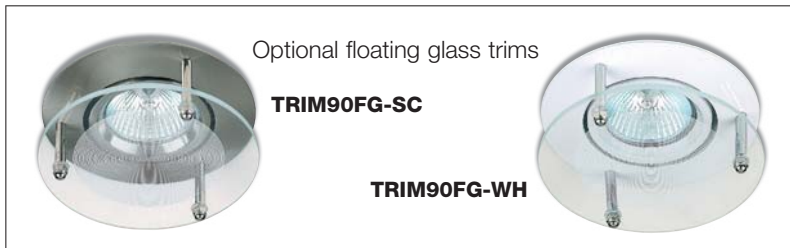

MODEL	CLASS	AIR / MOISTURE TRANSFER	INSULATION	F	Light Icon	CAVITY DEPTH	SIDE CLEARANCE
SVE90	CA135	Closed	Side Abutted	Yes	90mm	210mm	50mm

Integral Design Tiltable Downlight

HALOGEN
MRE16-35-D38
Included

- 15lm/W • 525 total lm • Dimmable
- 35Watts • 3,000K • CRI>100 • 38° Beam

LED
MR16-HPLED-WH

- 80lm/W • 480 total lm
- 6Watts • 3,000K • CRI>80 • 38° Beam

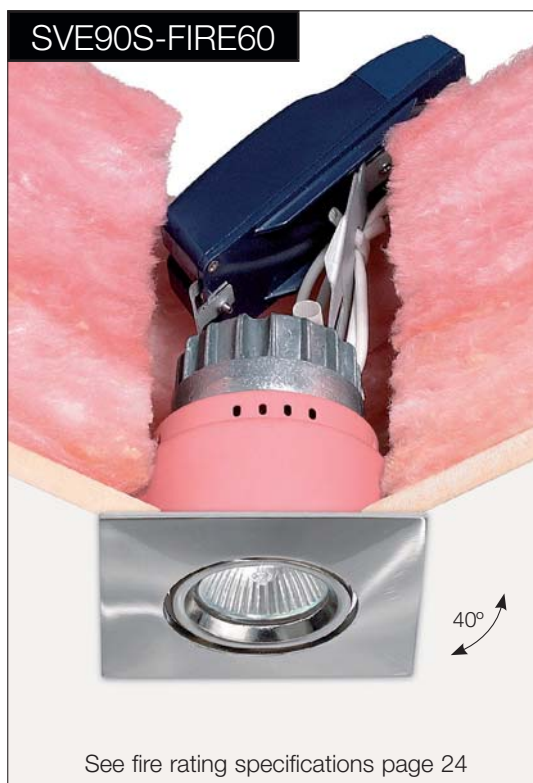
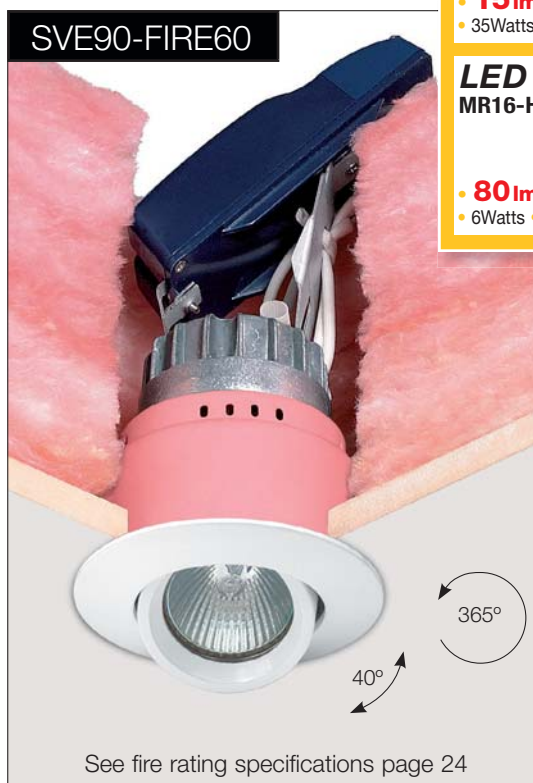
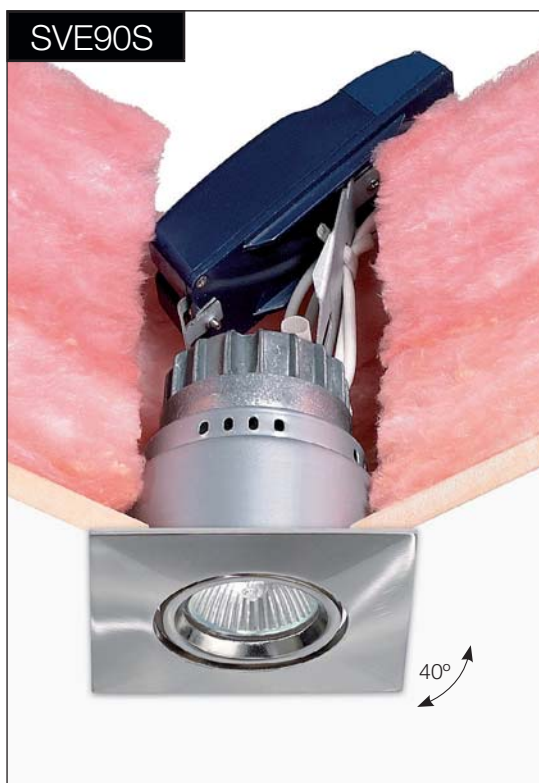

MODEL	CLASS	AIR / MOISTURE TRANSFER	INSULATION	F		CAVITY DEPTH	SIDE CLEARANCE
SVE90S	CA135	Closed	Side Abutted	Yes	90mm	210mm	50mm
SVE90-FIRE60	CA135	Closed	Side Abutted	Yes	90mm	210mm	50mm
SVE90S-FIRE60	CA135	Closed	Side Abutted	Yes	90mm	210mm	50mm

Architectural Multi Downlights

- Fully adjustable for tilt and rotation • Purchase Superlux transformers separately
- Patented CA-Coil and lamp holder with thermal cut off included

SILVER PREMIUM ARCHITECTURAL



SV-STLT1-SI



SV-STLT3-SI



SV-STLT2-SI

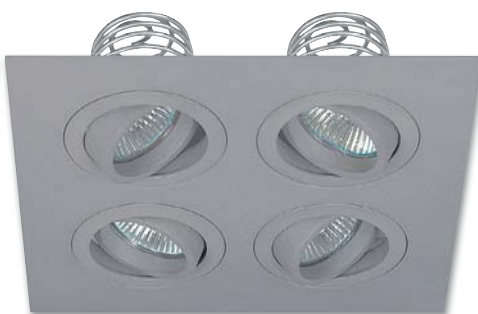

SV-STLT4-SI

HALOGEN MRE16-35-D38



- 15lm/W • 525 total lm • Dimmable
- 35Watts • 3,000K • CRI>100 • 38° Beam

LED MR16-HPLED-WH



- 80lm/W • 480 total lm
- 6Watts • 3,000K • CRI>80 • 38° Beam



SV-STLT1

112mm x 112mm



SV-STLT2

112mm x 200mm



SV-STLT3

112mm x 288mm



SV-STLT4

210mm x 210mm

SANDY WHITE PREMIUM ARCHITECTURAL



SV-STLT1-WH



SV-STLT3-WH



SV-STLT2-WH



SV-STLT4-WH

MODEL	CLASS	AIR / MOISTURE TRANSFER	INSULATION	F		CAVITY DEPTH	SIDE CLEARANCE
SV-STLT1	CA135	Closed	Side Abutted	Yes	83mmØ	200mm	100mm
SV-STLT2	CA135	Closed	Side Abutted	Yes	2x 83mmØ	200mm	100mm
SV-STLT3	CA135	Closed	Side Abutted	Yes	3x 83mmØ	200mm	100mm
SV-STLT4	CA135	Closed	Side Abutted	Yes	4x 83mmØ	200mm	100mm

MR16 Frame Lights

- Recessed Gimble Frame Lights • Silver Grey and White paint finishes
- Use Superlux SVE Halogen Transformers • Enclosed metal case
- Now with thermal cut off protection

HALOGEN
MRE16-35-D38



- **15lm/W** • 525 total lm • Dimmable
- 35Watts • 3,000K • CRI>100 • 38° Beam

LED
MR16-HPLED-WH



- **80lm/W** • 480 total lm
- 6Watts • 3,000K • CRI>80 • 38° Beam



CA 135°C MR16 MAX. 35W

SV-GMR1

- Flange 110mm Sq

CA 135°C MR16 MAX. 35W

SV-GMR2

- Flange 203mmL x 110mmW

CA 135°C MR16 MAX. 35W

SV-GMR3

- Flange 300mmL x 110mmW

CA 135°C MR16 MAX. 35W

SV-GMR4

- Flange 210mm Sq

MODEL	CLASS	AIR / MOISTURE TRANSFER	INSULATION	F		CAVITY DEPTH	SIDE CLEARANCE
SV-GMR1	CA135	Closed	Side Abutted	Yes	95 x 95mm	150mm	50mm
SV-GMR2	CA135	Closed	Side Abutted	Yes	95 x 190mm	150mm	50mm
SV-GMR3	CA135	Closed	Side Abutted	Yes	95 x 285mm	150mm	50mm
SV-GMR4	CA135	Closed	Side Abutted	Yes	195 x 195mm	150mm	50mm

Pathway Recessed Lights

LED DEFLECTOR LIGHTS



LRL133-SC



LRL133-WH

INTEGRAL



- 80 lm/W • 240 total lm
- 3Watts • 3,000K • CRI>80



LRL133

- 1x high power LED
- 90mmØ, cut 75mmØ hole
- 85mm cavity depth
- Warm White 3,000K
- Electronic control gear included
- 35Lux at 400mm

G4.0

CAPSULE DEFLECTOR LIGHTS



SV133-SC



SV133-WH

HALOGEN HCAP-10



- 10 lm/W • 100 total lm • Dimmable
- 10Watts • 3,000K • CRI>100



SV133

- 90mmØ
- 48mm cavity depth
- Cut 75mmØ hole
- Clear safety glass

G4.0



SVU-10-BS



SVU-10-SC



SVU-10-WH

LED CAP-3WLED-WW



- 50 lm/W • 150 total lm
- 3Watts • 3,000K • CRI>80 • 360° Beam



SVU-10

- Fits 58mmØ hole



LLED10006-SS

INTEGRAL



- 90 lm/W • 135 total lm
- 1.5Watts • 3,000K • CRI>80 • 15° Beam



LLED10006-SS

- 316 marine grade trim
- 53mmØ x 62mmD
- 45mmØ mounting hole
- Frosted glass lens
- Made from hi-grade die-cast aluminium

Energy Efficient Recessed Lights

LED DEFLECTOR STEP LIGHTS



LRL233-SC



LRL233-WH

INTEGRAL



- 80 lm/W • 240 total lm
- 3Watts • 3,000K • CRI>80



LRL233

- 1 x high power LED
- 90mmH x 100mmW
- Electronic control gear included
- 35 lux at 400mm

MINIATURE RECESSED



SLED-R2WH

SLED-RT2WH

INTEGRAL



- 70 lm/W • 28 total lm
- 0.4Watts • 3,000K • CRI>80



- Linkable into multiple units leads In 0.5m Out 1.5m
- Stainless Steel mountings
- 20 Lux at 300mm
- Use constant voltage 12v AC 50Hz or DC power supply
- Use Superlux GV-T60 or SLED-IPEC60 transformer

SLED-R2WH

- 40mmØ flange

SLED-RT2WH

- Flange 71mmL x 40mmW

MODEL	CLASS	AIR / MOISTURE TRANSFER	INSULATION			CAVITY DEPTH	SIDE CLEARANCE
LRL233	IC	Closed	Cover over - non flammable	Yes	80 x 85mm	85mm	10mm
SLED-R2WH	IC-F	Closed	No restrictions	Yes	32mm	50mm	N/A
SLED-RT2WH	IC-F	Closed	No restrictions	Yes	32mm	50mm	N/A

Recessed Deflector Lighting



- Modern indirect lighting • Floor and step lighting applications
- Accent lighting of feature walls and pictures etc • Accentuation of architectural features
- Purchase transformers separately

LED CAP-3WLED-WW

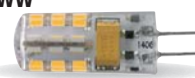

- 50 lm/W • 150 total lm
- 3Watts • 3,000K • CRI>80 • 360° Beam

HALOGEN HCAP-35



- 10 lm/W • 350 total lm • Dimmable
- 35Watts • 3,000K • CRI>2100

INTERIOR



SDV76-SI



SDV220-SI



SDV76-SI Halogen

Mount low on walls for floor or tread lighting.
Outside dimensions 90mmH x 90mmW
• Cavity depth 105mm



SDV220-SI Halogen

Can be ceiling mounted to accent upper walls, pictures etc.
Outside dimensions 235mmH x 80mmW
• Cavity depth 105mm



SDU235-SI



SDF235-SI



SDU235-SI

Can be ceiling mounted to accent upper walls, pictures etc.
Outside dimensions 245mmH x 190mmW
• Cavity depth 105mm



SDF235-SI Fluorescent

Low heat emission, fitting can be mounted low on wall. Can be used for all interior applications.
Outside dimensions 245mmH x 190mmW
• Cavity depth 105mm

Recessed Deflector Lights

NEW

- Extra clips supplied for direct mounting into interior walls
- Supplied with mounting niche for exterior installation
- Epistar LED Technology
- Made from die cast aluminium
- Indoor & outdoor use
- Integral control gear wire directly to mains

LED DEFLECTOR LIGHTS



F6601-SI



F6601-WH



F6602-SI



F6602-WH



F6603-SI



F6603-WH

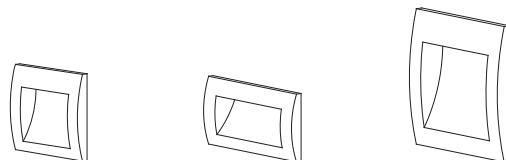

Hole sizes:

MODEL	F6601	F6602	F6603
Hole for Plastic Niche	79mm Wide 79mm High	125mm Wide 63mm High	125mm Wide 115mm High
Hole for direct mounting in Wall Lining <i>Note: Make test cut using off-cut of board being used</i>	71mm Wide 71mm High	114mm Wide 53mm High	116mm Wide 116mm High

INTEGRAL LED

- **90 lm/W** • 90 total lm
- 1Watts • 3,000K • CRI>80



F6601

- 90mm square
- 60mm recessed cavity depth

INTEGRAL LED

- **96 lm/W** • 290 total lm
- 3Watts • 3,000K • CRI>80



F6602

- 70mmH x 140mmW
- 60mm recessed cavity depth

INTEGRAL LED

- **96 lm/W** • 290 total lm
- 3Watts • 3,000K • CRI>80



F6603

- 140mm square
- 60mm recessed cavity depth

Round LED Surface Lights

NEW

- Surface mounted, no recess required
- Interchangeable covers click onto the main body
- Covers supplied separately
- Covers available in 3 colours; Charcoal, Silver or White
- 150mmØ x 22mm depth
- Polycarbonate body and lens - covers made from ABS
- Indoor & outdoor use
- Integral control gear wire directly to mains

ROUND PLAIN



LK1501 (Body)

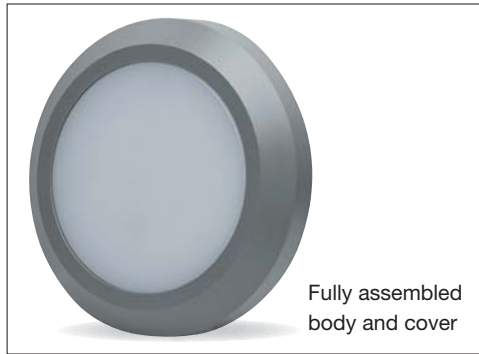

Fully assembled body and cover



LK1551-CC

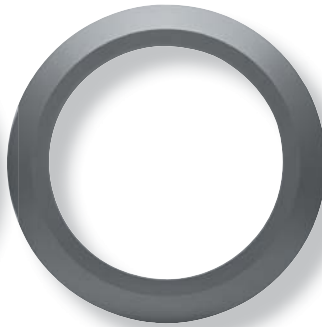

LK1551-SI



LK1551-WH

INTEGRAL LED



- **66 lm/W** • 200 total lm
- 3Watts • 3,000K • CRI>80



LK1501

- 3 Watt integral LED main body, wall or ceiling mount

LK1551

- Cover only, place onto LK1501

ROUND DEFLECTOR



LK1503 (Body)

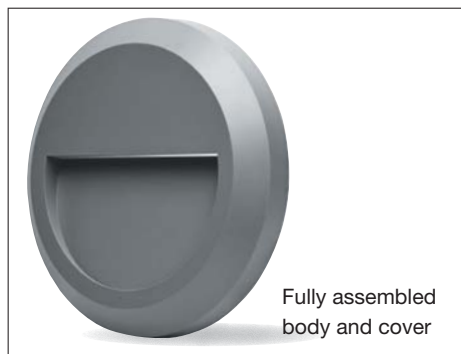

Fully assembled body and cover



LK1553-CC



LK1553-SI

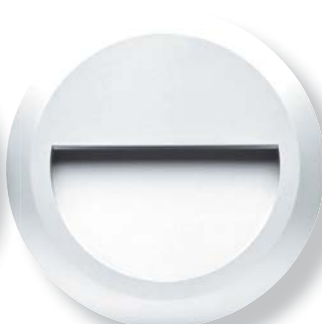

LK1553-WH

INTEGRAL LED



- **66 lm/W** • 200 total lm
- 1.5Watts • 3,000K • CRI>80



LK1503

- 1.5 Watt integral LED main body

LK1553

- Cover only, place onto LK1503

Square LED Surface Lights

NEW

- Surface mounted, no recess required
- Interchangeable covers click onto the main body
- Covers supplied separately
- Covers available in 3 colours; Charcoal, Silver or White
- 124mm square x 22mm depth
- Polycarbonate body and lens - covers made from ABS
- Indoor & outdoor use
- Integral control gear wire directly to mains

SQUARE PLAIN



LK1401 (Body)



Fully assembled
body and cover

INTEGRAL LED

- **76 lm/W** • 230 total lm
- 3Watts • 3,000K • CRI>80



LK1401

- 3.5 Watt integral LED main body, wall or ceiling mount



LK1441-CC

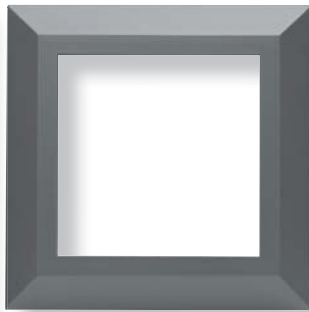

LK1441-SI

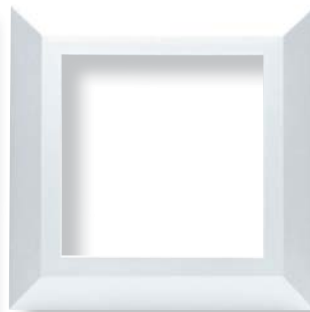

LK1441-WH

LK1441

- Cover only, place onto LK1401

SQUARE DEFLECTOR



LK1403 (Body)



Fully assembled
body and cover

INTEGRAL LED

- **66 lm/W** • 100 total lm
- 1.5Watts • 3,000K • CRI>80



LK1403

- 1.5 Watt integral LED main body



LK1443-CC



LK1443-SI



LK1443-WH

LK1443

- Cover only, place onto LK1403

Surface Mount LED Brick Lights

NEW

- Interchangeable covers simply click onto the main body
- Covers supplied separately
- Covers available in 3 colours; Charcoal, Silver or White
- Polycarbonate body and lens - covers made from ABS
- Indoor & outdoor use
- Integral control gear wire directly to mains

HORIZONTAL PLAIN



LK2301 (Body)

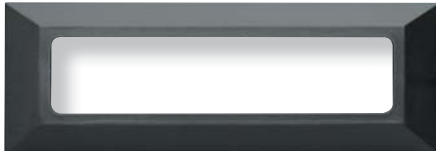

LK2331-CC



LK2331-SI



LK2331-WH



Fully assembled body and cover

HORIZONTAL DEFLECTOR



LK2302 (Body)



LK2332-CC



LK2332-SI



LK2332-WH



Fully assembled body and cover

INTEGRAL LED

- 87 lm/W • 350 total lm
- 4Watts • 3,000K • CRI>80



LK2301

- 4 Watt integral LED main body, wall or ceiling mount
- 230mmL x 80mmW x 22mm depth

LK2331

- Cover only, place onto LK2301

INTEGRAL LED

- 60 lm/W • 180 total lm
- 3Watts • 3,000K • CRI>80



LK2302

- 3 Watt integral LED main body
- 230mmL x 80mmW x 22mm depth

LK2332

- Cover only, place onto LK2302

VERTICAL DEFLECTOR



LK2303 (Body)



LK2333-CC



LK2333-SI



LK2333-WH



Fully assembled body and cover

INTEGRAL LED

- 50 lm/W • 50 total lm
- 1Watts • 3,000K • CRI>80



LK2303

- 1 Watt integral LED main body
- 200mmH x 80mmW x 22mm depth

LK2333

- Cover only, place onto LK2303

FLUORESCENT
PL-9CW



- 68 lm/W • 612 total lm
- 9Watts • 4,000K • CRI>82

 Manufactured in Italy







Polycarbonate Fluorescent flush mounted brick lights

- Magnetic ballast included

Polycarbonate Brick Lights

F SERIES FLUORESCENT



Brick Recess, Plain **F3725-BL**



Brick Recess, Plain **F3725-WH**



Brick Recess, Louvre **F3729-BL**

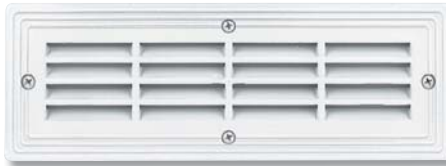

Brick Recess, Louvre **F3729-WH**



Brick Recess, Eyelid **F3733-BL**



Brick Recess, Eyelid **F3733-WH**

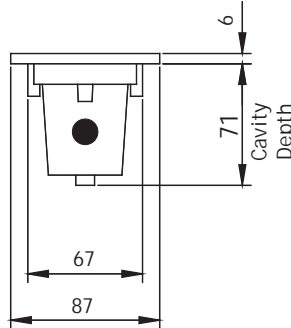
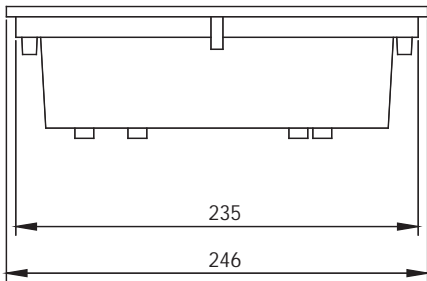

F SERIES MOUNTING BOX



Furniture Lighting

NEW

RECESSED LED



SUDLED4-SI



SUDLED4-WH



SUDLED4-BL



SUDLED4-GD

INTEGRAL



- 80 lm/W • 320 total lm
- 4Watts • 3,000K • CRI>80 • 60° Beam



Manufactured in Korea

SUDLED4

- 4 Watt high power LED
- Can be linked together
- 75mmØ x 16mmH
- Cut hole size 67mmØ
- Constant voltage DC
- Recommended drivers DLED24 RANGE



For mounting into plaster board

SUDLED-CLIP

Cut hole size 70mmØ

SURFACE MOUNT RING

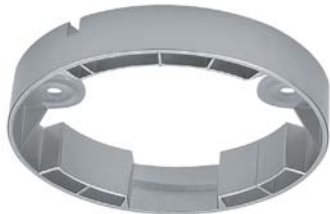

SUDR-SI

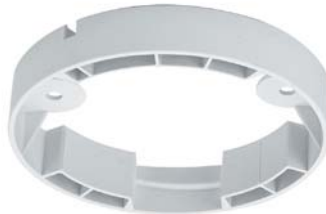

SUDR-WH



SUDR-BL



SUDR-GD



EXAMPLE



DLED24-15

SLED-EXT2



DLED24-15

- 121mmL x 45mmW X12mmH
- 6 outlet junction box 70mmL x 16mmH x 31mmW
- 1-15 watts

SLED-EXT2

- Powersupply extension cable 2500mmL

DIVA Linkable LED Strip



- Miniature design • Seamless connection • 6 lengths available in 3,000K Warm White or 6,000K Daylight
- Dimmable, RA80, 75 lumens per watt • Up to 40,000 hours • Operating temperature 0-40°C



Seamless design dark spot free at linking point

INCLUDED MOUNTING OPTIONS

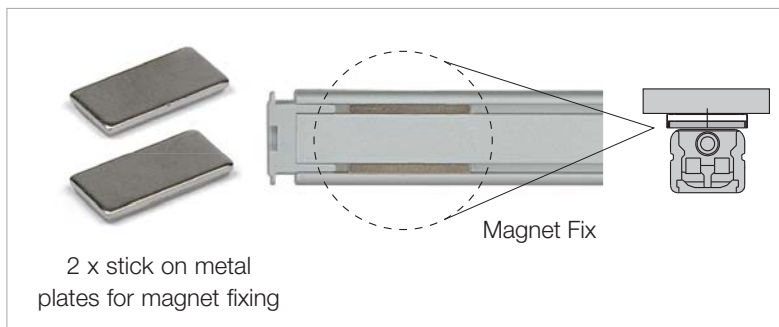

2 x stick on metal plates for magnet fixing

Magnet Fix



End Cap supplied with each fixture



2 x fixing clips

OPTIONAL



Round diffuser
• Spot free LED
• Supplied with End Caps

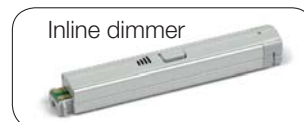

Inline dimmer

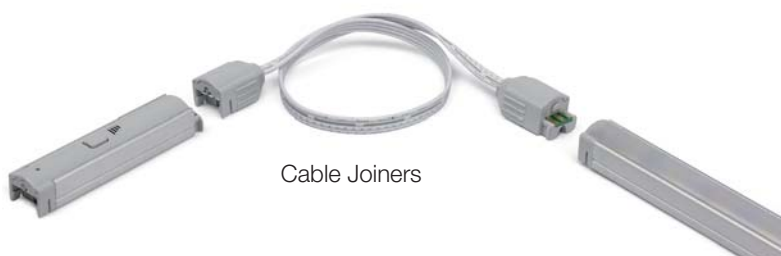
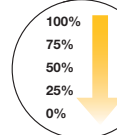

Cable Joiners

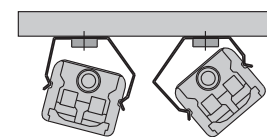

15° Angle clips
40°

DIVA Linkable LED Strip

975 lm/M



Manufactured in Korea

CV 24V DC



- Miniature design • Seamless connection • 6 lengths available in 3,000K Warm White or 6,000K Daylight
- Dimmable RA80 75 lumens per watt • Up to 40,000 hours • Operating temperature 0-40°C • Supplied with flat diffuser

DIVA STRIPLIGHT

DIVA1-FLEX-WW
DIVA1-FLEX-DL

DIVA1-WW
DIVA1-DL

DIVA3-WW
DIVA3-DL

DIVA4-WW
DIVA4-DL

DIVA7-WW
DIVA7-DL

DIVA11-WW
DIVA11-DL

DIVA15-WW
DIVA15-DL

- 1 Watt**
DIVA1-FLEX
• Flexible corner joint
- 1 Watt**
DIVA1
• 100mmL overall
- 3 Watt**
DIVA3
• 193mmL overall
- 4 Watt**
DIVA4
• 285mmL overall
- 7 Watt**
DIVA7
• 565mmL overall
- 11 Watt**
DIVA11
• 845mmL overall
- 15 Watt**
DIVA15
• 1123mmL overall

DIMENSIONS

Model	A (mm)	B (mm)	C (mm)
DIVA1	95	100	117
DIVA3	188	193	210
DIVA4	280	285	302
DIVA7	560	565	582
DIVA11	840	845	862
DIVA15	1118	1123	1140

DIVA FEED

DIVA-FEED

- DIVA-FEED**
- Power supply feed cable 1x required for each run of strip
 - Compatible with DLED LED drivers

DIVA Linkable LED Strip



Manufactured in Korea



DIVA DIMMER

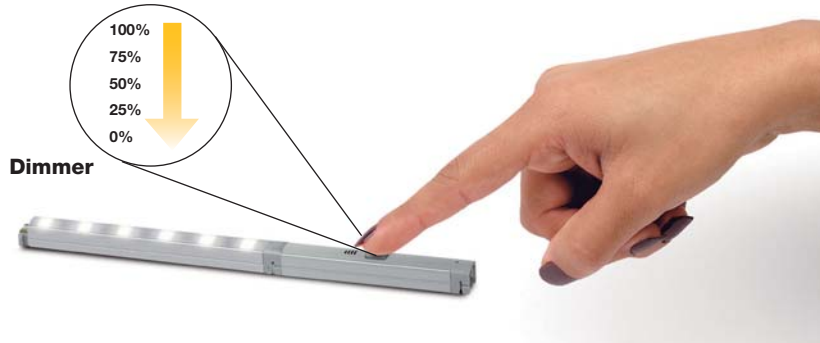

MAX 55W

DIVA-DIM

- 73mmL overall
- Will DIM at levels of 100%, 75%, 50%, 25%, 0%
- Allows you to memorise/set preferred light level
- Automatic 'swing mode' will move between all light levels continuously
- 73mmL including connectors

DIVA JOINER CABLES



DIVA150-JOIN

- 150mmL

DIVA300-JOIN

- 300mmL

DIVA600-JOIN

- 600mmL

DIVA1200-JOIN

- 1200mmL

DIVA1800-JOIN

- 1800mmL

OPTIONAL ROUND DIFFUSERS

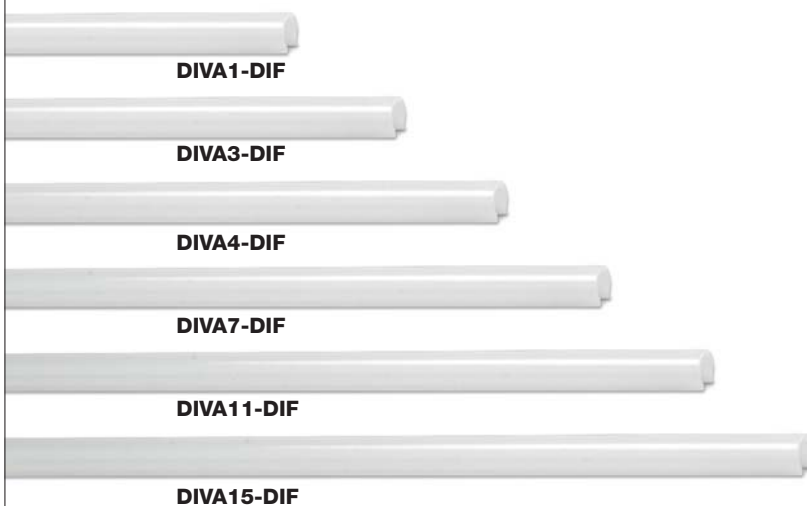

DIVA#-DIF

= Match number with fixture number eg. DIVA4-DIF will fit DIVA4-WW or DIVA4-DL

- Slide off diffuser supplied and replace with round diffuser
- Will give even diffusion of light from LED, will completely remove spot effect.
- Round end caps supplied with diffuser

15/40 BRACKET

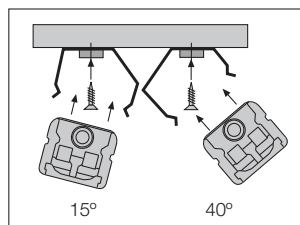

DIVA-4015CLIP

- Pair of 2x mounting clips
- Mounts DIVA series striplights on a 15 degree or 40 degree angle

LED Diva & Dual Drivers

15 WATT



DLED24-15

CV 24V DC **MAX.** 15W

DLED24-15

- 121mmL x 45mmW x 12mmH
- 6 outlet junction box 70mmL x 16mmH x 31mmW
- 1-15 watts

30 WATT



DLED24-30

CV 24V DC **MAX.** 30W

DLED24-30

- 150mmL x 42mmW x 33mmH
- 6 outlet junction box 70mmL x 18mmH x 33mmW
- 1-30 watts

75 WATT



DLED24-75

CV 24V DC **MAX.** 75W

DLED24-75

- 183mmL x 60mmW x 33mmH
- 6 outlet junction box 70mmL x 18mmH x 33mmW
- 1-75 watts

LED DIMMER MODULE



SLED-DIM

SLED-DIM

- Install between the ELV DC power supply and the Superlux DC LED lamps.
- Suitable for Dimming constant voltage 12/24V DC LED lighting
- Maximum output current 2A.
- Use in conjunction with a potentiometer such as clipsal 500k OHM (30 POTFM)

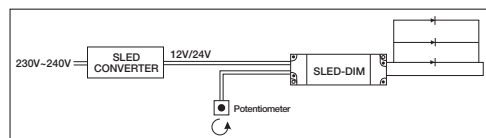

Diva series max units per driver

LED Driver	DLED24-30	DLED24-75
Strip		
DIVA1	25	62
DIVA3	10	25
DIVA4	7	18
DIVA7	4	10
DIVA11	2	6
DIVA15	2	5

- Note Diva max run in one length 55 watts

Dual series max units per driver

LED Driver	DLED24-30	DLED24-75
Strip		
DUAL3	10	25
DUAL6	5	12
DUAL12	2	6
DUAL18	1	4
DUAL24	1	3

- Note Dual max run in one length 75 watts

DUAL Linkable LED Strip

1470 lm/M

CV 24V DC



Manufactured in Korea



- Compact size • Seamless connection • 5 lengths available • Colour adjustable from Warm White 2,700K to Daylight 6,000K
- Can memorise desired light set up • Decorative swing mode automatically fades IN and OUT of all colours of white light 2,700K, 3,500K, 4,000K, 5,000K, 6,000K • RA80 75 lumens per watt • Up to 40,000 hours • Operating temperature 0-40°C



2,700k 3,500k 4,000k 5,000k 6,000k

Lux at 1 Metre

62 83 146 99 83

DIMMER & COLOUR ADJUSTABLE

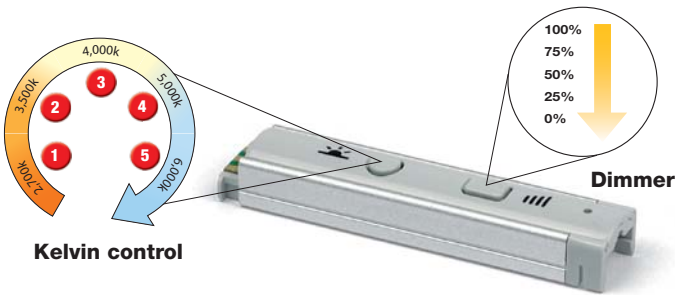

INCLUDED MOUNTING OPTIONS

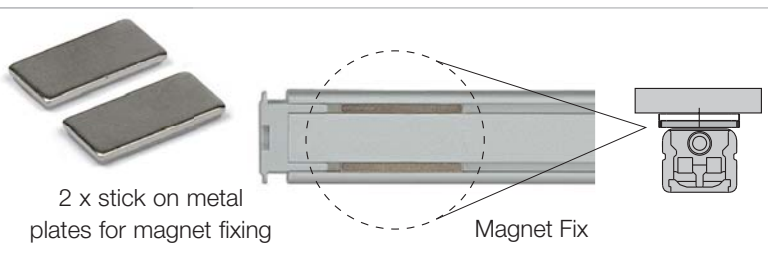

OPTIONAL

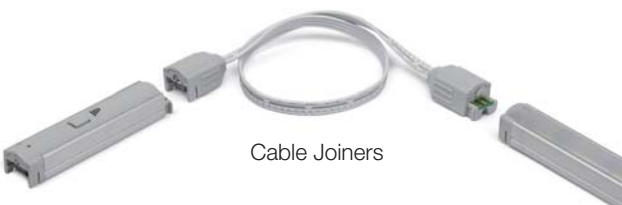

Round diffuser

- Spot free
- Supplied with End Cpas

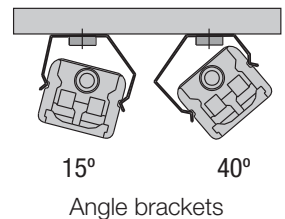

DUAL Linkable LED Strip

1470 lm/M



Manufactured in Korea

CV 24V DC



- Compact size • Seamless connection • 5 lengths available • Adjustable white colour shades from Warm White 2,700K to Daylight 6,000K
- Can memorise desired light set up • Decorative swing mode automatically fades IN and OUT of all colours of white light 2,700K, 3,500K, 4,000K, 5,000K, 6,000K • RA80 75 lumens per watt • Up to 40,000 hours • Operating temperature 0-40°C • Supplied with flat diffuser



3 Watt

DUAL3-CA

- 145mmL overall

6 Watt

DUAL6-CA

- 285mmL overall

12 Watt

DUAL12-CA

- 565mmL overall

18 Watt

DUAL18-CA

- 845mmL overall

24 Watt

DUAL24-CA

- 1123mmL overall

DIMENSIONS

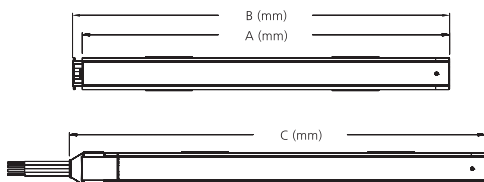

Model	A (mm)	B (mm)	C (mm)
DUAL3	140	145	162
DUAL6	280	285	302
DUAL12	560	565	582
DUAL18	840	845	862
DUAL24	1118	1123	1140

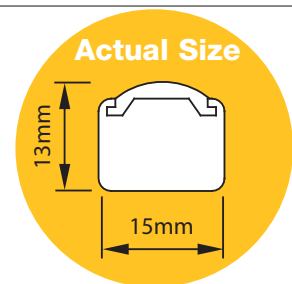

DIMMER & COLOUR ADJUSTABLE

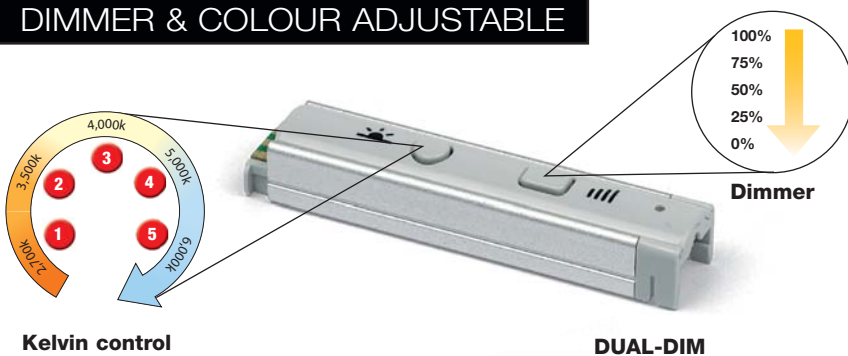

MAX. 75W

DUAL-DIM

- Dimmer & Colour adjustable Kelvin control
- 72mmL including connectors

Square Button

- Dims 100%, 75%, 50%, 25%, 0%
- Hold for 3 sec and will swing through all colours and light levels automatically.

Round Button

- Will adjust colour temperature from Warm White 2,700K through to Daylight 6,000K. Press button quickly to set at 2,700K, 3,500, 4,000K, 5,000K or 6,000K.

DUAL FEED



DUAL-FEED

- Power supply feed cable
- 1x required for each run of strip
- 2500mmL
- Compatible with DLED drivers

DUAL Linkable LED Strip



Manufactured in Korea

DUAL JOINER CABLES

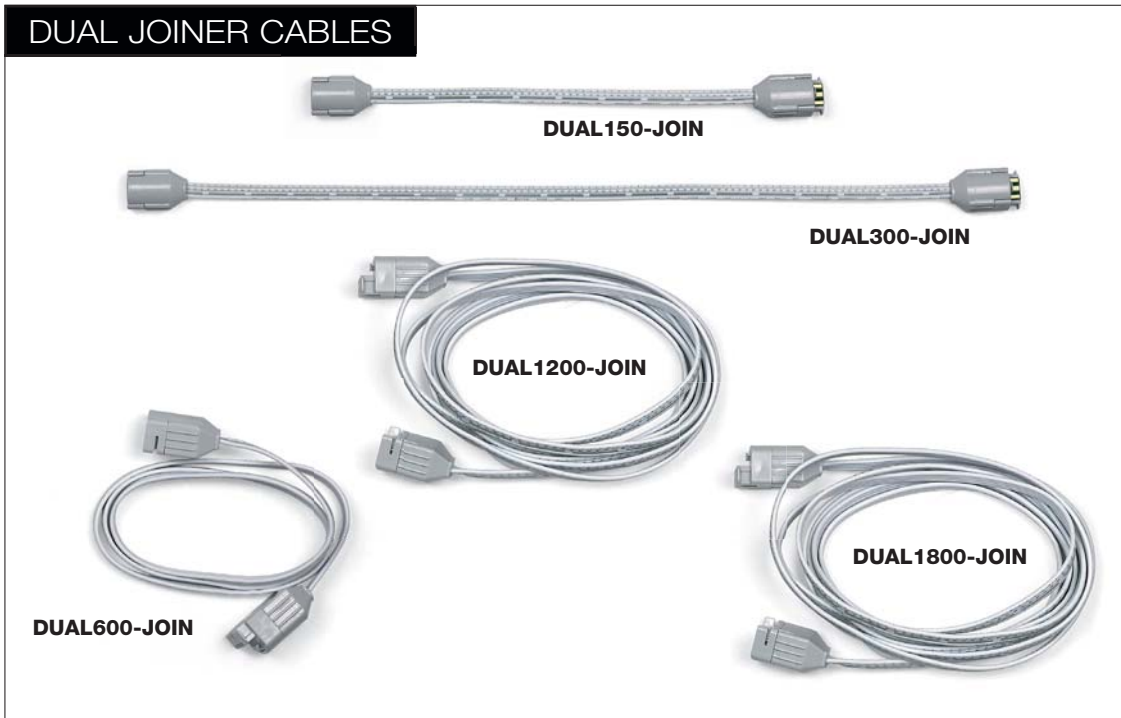

DUAL150-JOIN

- 150mmL

DUAL300-JOIN

- 300mmL

DUAL600-JOIN

- 600mmL

DUAL1200-JOIN

- 1200mmL

DUAL1800-JOIN

- 1800mmL

OPTIONAL ROUND DIFFUSERS

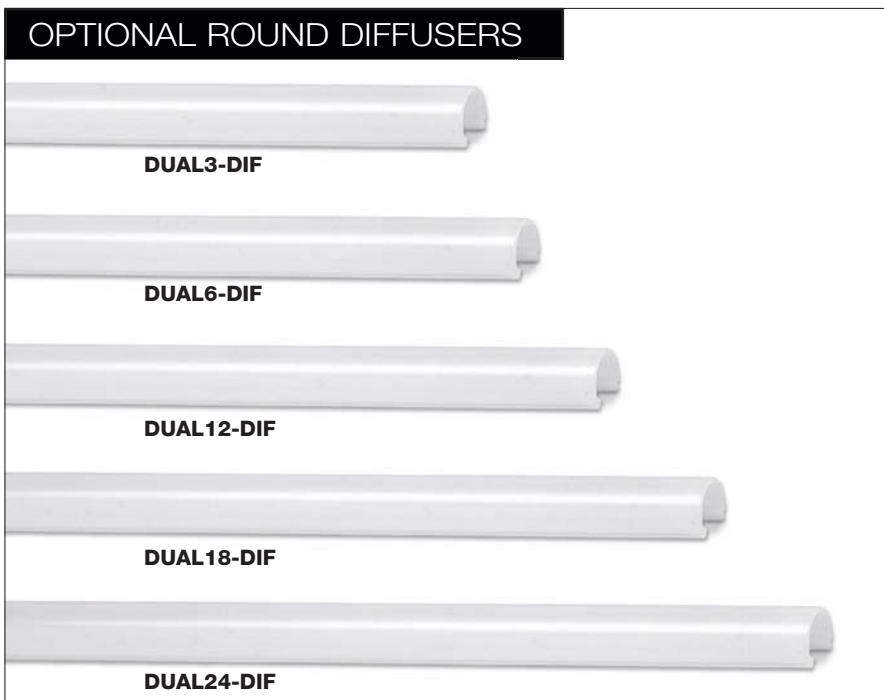

DUAL#-DIF

= Match number with fixture number eg. DUAL12-DIF will fit DUAL12-CA

- Slide off diffuser supplied on DUAL model fixture and slide on round diffuser. The round diffuser will give even light from LED'S, will completely remove spot effect.
- Round end caps supplied with diffuser

15/40 BRACKET



DUAL-4015CLIP

- Pair of 2x mounting clips
- Mounts DIVA series striplight on a 15 degree or 40 degree angle

LED Mini Panels

- A very long service life, they can be installed in hard to access places where maintenance is difficult.
- Shock resistant - recommended for vehicles, escalators, lifts etc.
- Low voltage - completely safe.
- Small profiles allows for many installation configurations.
- Does not create UV or infrared radiation can be used close to textiles, paper and food.
- Very low temperature around lighting modules.

ROUND

SLED-C19WH
(White) 4,100k



SLED-C19BE
(Blue)



SLED-C19RD
(Red)

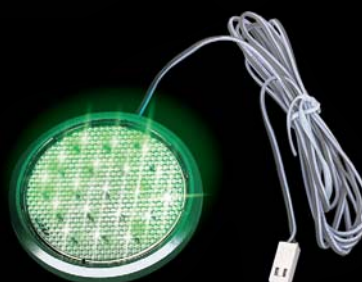

SLED-C19GN
(Green)

SLED-C19AM
(Amber)

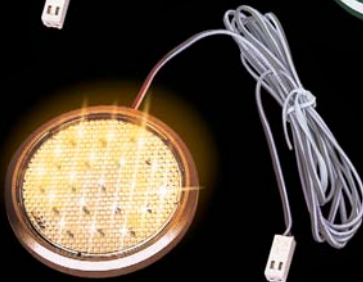

SLED-C19

- 58mmØ x 6mmH
- 19 Diodes per lamp
- 12 Volt DC 1.2watts
- Plug into DC power supply or 12volt battery
- 100 Lux at 300mm
- 1500mm of lead
- White 5000k
- 150 Lumens

Spectrum ,Wave Lengths of SLED Models

Colour	Nanometers
White	Broad spectrum (no dominant wave length)
Blue	464-476
Red	617-633
Green	520-535
Amber	588-594

SQUARE

SLED-SQ6WH
(White) 4,100k



SLED-SQ6BE
(Blue)



SLED-SQ6RD
(Red)

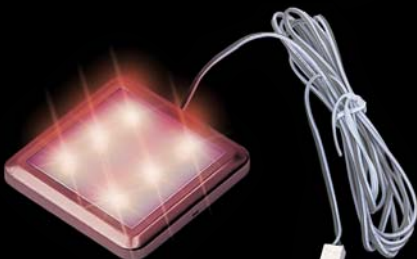

SLED-SQ6GN
(Green)

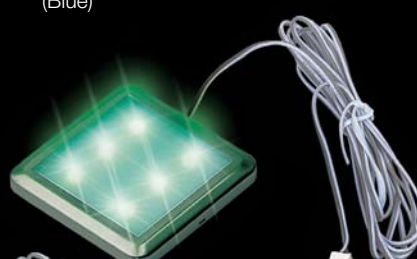

SLED-SQ6AM
(Amber)



SLED-SQ6

- 52mm x 52mm x 6mmH
- 6 Diodes per lamp
- 12 Volt DC 0.5watts
- Plug into DC power supply or 12volt battery
- 35 Lux at 300mm
- 1500mm of lead
- White 5000k
- 50 Lumens

12 Volt DC Supply LED Rigid Strip

250 lm/M



- CV** 12V DC
- 300L x 5.5H x 9mmW
 - 12 Diodes per length
 - Directly linkable
 - 12volt DC 0.8watts
 - Plug into DC power supply using SLED-FEED (see below) or 12volt battery
 - 65 Lux at 300mm
 - Supplied with 2x Stainless Steel mounting clips
 - White 4100k



Close up showing Connecting ends and discreet mounting clips

STRIP LED ACCESSORIES



SLED-FEED
Power supply lead (1.5m)

SLED-JOIN
Flexible Link (80mm)

LED POWER SUPPLY



SLED-EC15

SLED-EC5

- CV** 12V DC
- SLED-EC15**
- 121L x 45W x 20mmH Min hole Ø 50mm
 - Secondary 12volts direct current
 - 1-15watts
 - 12 way outlet
- SLED-EC5**
- 89L x 45W x 23mmH Min hole Ø 50mm
 - Secondary 12volts direct current
 - 0.5 - 5watts
 - 4 way outlet

LED DIMMER MODULE

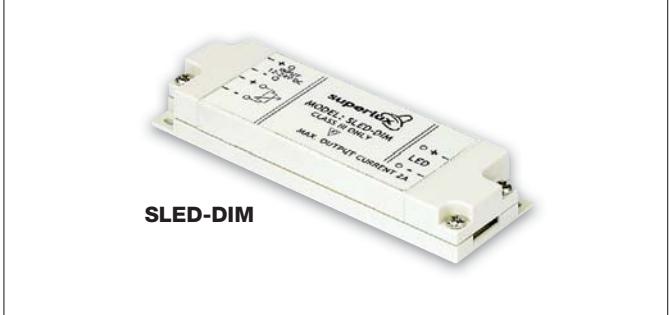

SLED-DIM

- SLED-DIM**
- Install between the ELV DC power supply and the Superlux DC LED lamps.
 - Suitable for Dimming constant voltage 12/24V DC LED lighting.
 - Maximum output current 2A.
 - Use in conjunction with a potentiometer such as clipsal 500k OHM (30 POTFM)

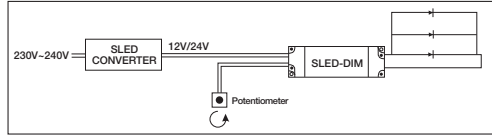

T8 Fluorescent Lighting

80 lm/W

T8

Lamp Included

F

5000 K

230V-240V



Electronic Ballast

- Complies with minimum energy performance standards
- Individually switched

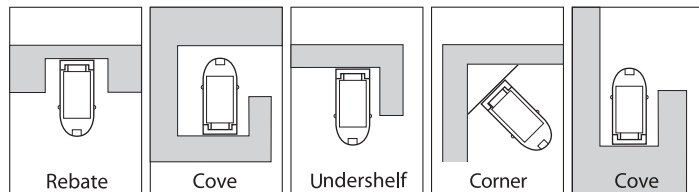

SFE Fluorescent Series		
Model	Mounting holes	Cable entry distance from end
SFE-36	1025mm	280mm
SFE-30	715mm	280mm
SFE-18	415mm	170mm
SFE-15	310mm	130mm
SFE-10CS	180mm	130mm

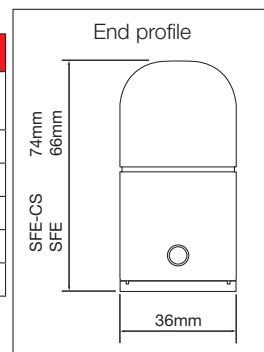

SFE SERIES

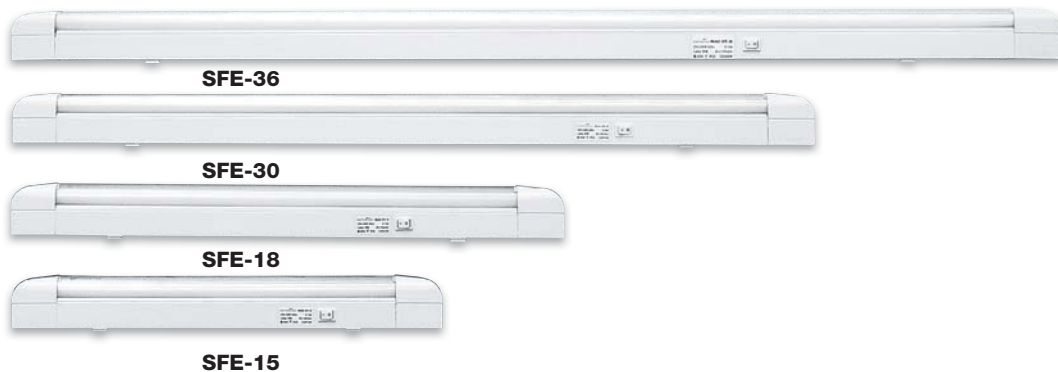

- 36W SFE-36** (1265mmL)
- 30W SFE-30** (960mmL)
- 18W SFE-18** (655mmL)
- 15W SFE-15** (500mmL)

SFE CORD SET SERIES



- 18W SFE-18 CS** (655mmL)
 - Cable length 1800mm
- 10W SFE-10 CS** (412mmL)
 - Cable length 1800mm

ECG must not be installed on a circuit with inductive loads.

SLT4 Linkable LED Striplighting

NEW



• Fixture lengths exclude connectors

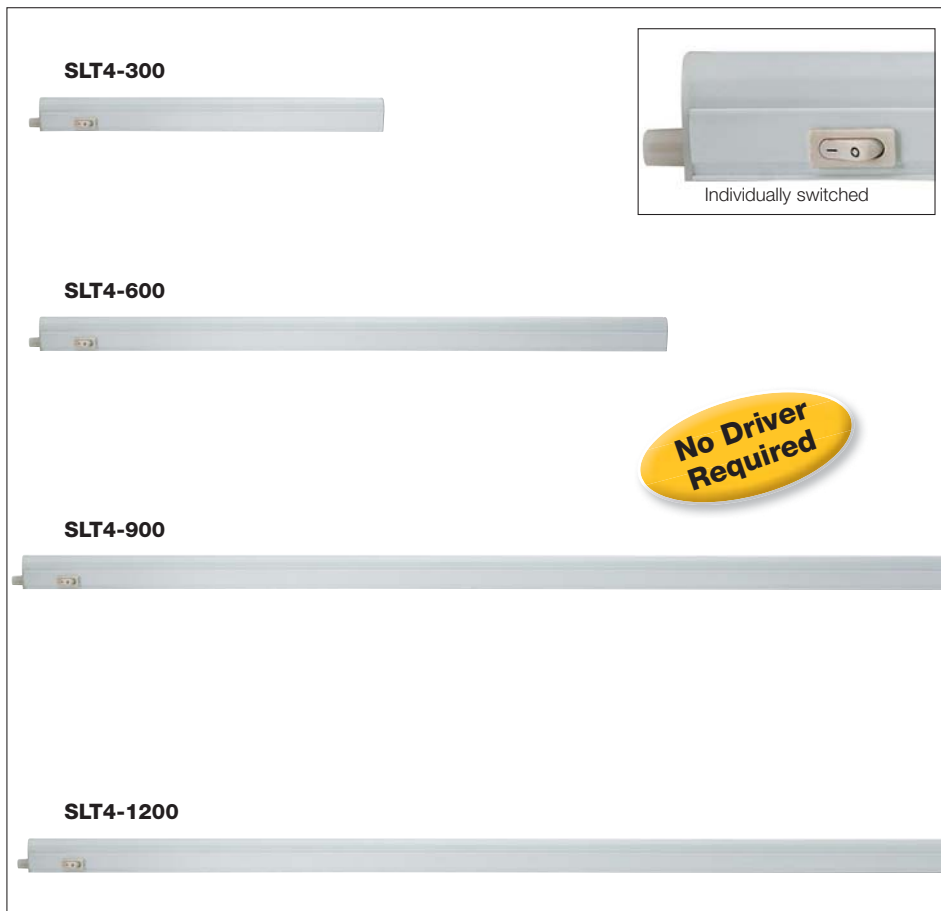

No Driver Required

INTEGRAL LED

- **86 lm/W** • 520 total lm
- 6Watts • 6,000K • CRI>80

SLT4-300 • 315mmL

INTEGRAL LED

- **86 lm/W** • 860 total lm
- 10Watts • 6,000K • CRI>80

SLT4-600 • 575mmL

INTEGRAL LED

- **98 lm/W** • 1180 total lm
- 12Watts • 6,000K • CRI>80

SLT4-900 • 875mmL

INTEGRAL LED

- **91 lm/W** • 1640 total lm
- 18Watts • 6,000K • CRI>80

SLT4-1200 • 1175mmL

SFT4 CONNECTORS

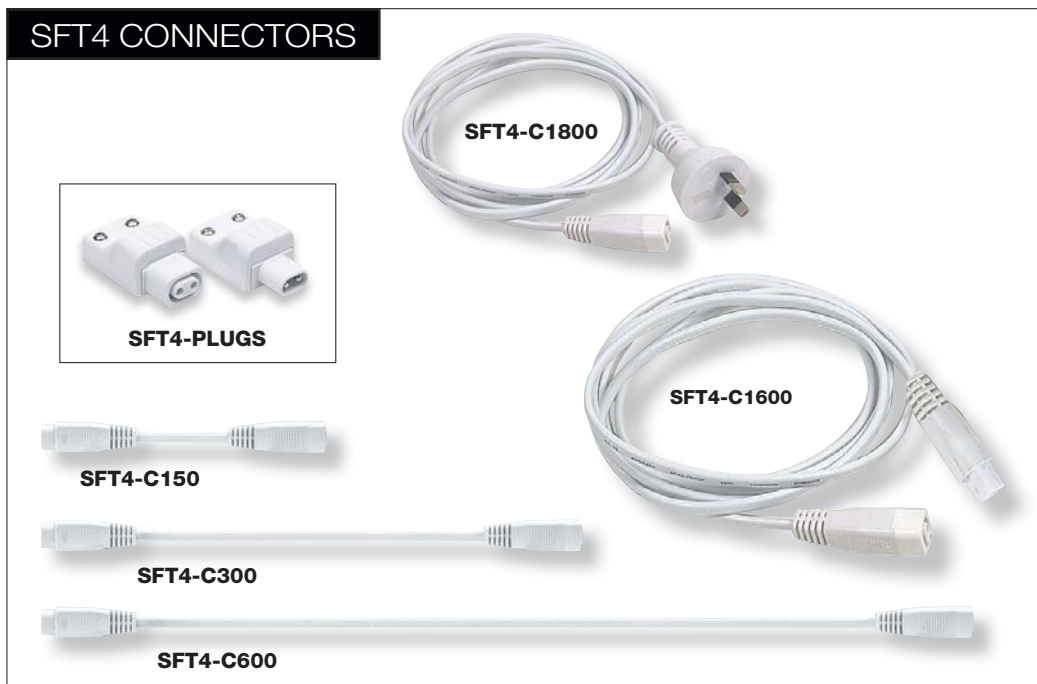

SFT4-C1800
Power supply cord (1800mm)

SFT4-PLUGS
1 pair of re-wireable plugs

SFT4-C1600
• 1600mm long connector cable

SFT4-C150
Connector cable (150mm)

SFT4-C300
cable (300mm)

SFT4-C600
Connector cable (600mm)

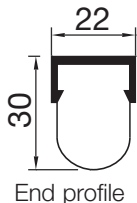

- Australian Approved connector cables NSW 22616
- Directly linkable to provide continuous lines of light
- Very low heat output
- When joined fittings can be individually switched
- Built in Electronic Driver
- Supplied complete with diffuser and metal mounting clips
- Fixtures may be linked with SFT4 cable connectors up to 120 watts maximum

ECG must not be installed on a circuit with inductive loads.

T5 Fluorescent Vanity Lighting

84lm/W

4000
K

T5

Lamps
Included

230V-
240V

- Electronic ballast
- Instant start
- Open back for easy cable entry

ARCH STRIP LIGHT



DFA-8



DFA-14



DFA-21



DFA-28

DFA-8

- Chrome and Satin Chrome
- 8watts
- 339mmL x 68mmH x 76mmD

DFA-14

- Chrome and Satin Chrome
- 14watts
- 600mmL x 68mmH x 76mmD

DFA-21

- Chrome and Satin Chrome
- 21watts
- 900mmL x 68mmH x 76mmD

DFA-28

- Chrome and Satin Chrome
- 28watts
- 1200mmL x 68mmH x 76mmD

SQUARE STRIP LIGHT



DFS-8



DFS-14



DFS-21



DFS-28

DFS-8

- Satin Chrome
- 8watts
- 345mmL x 40mmH x 58mmD

DFS-14

- Satin Chrome
- 14watts
- 605mmL x 40mmH x 58mmD

DFS-21

- Satin Chrome
- 21watts
- 905mmL x 40mmH x 58mmD

DFS-28

- Satin Chrome
- 28watts
- 1205mmL x 40mmH x 58mmD

TILTABLE STRIP LIGHT



DFT-8



DFT-14



DFT-21

DFT-8

- Satin Chrome and Grey
- 8watts
- 340mmL x 45mmH x 83mmD

DFT-14

- Satin Chrome and Grey
- 14watts
- 606mmL x 45mmH x 83mmD

DFT-21

- Satin Chrome and Grey
- 21watts
- 906mmL x 45mmH x 83mmD

UP/ DOWN STRIP LIGHT



DFL-8



DFL-14



DFL-21

DFL-8

- Satin Chrome
- 8watts
- 328mmL x 60mmH x 115mmD

DFL-14

- Satin Chrome
- 14watts
- 598mmL x 60mmH x 115mmD

DFL-21

- Satin Chrome
- 21watts
- 898mmL x 60mmH x 115mmD

Vanity & Picture Lights

NEW

ACRYLIC & CHROME



DLA-8



DLA-12



DLA-18

INTEGRAL



- **76 lm/W** • 610 total lm
- 8Watts • 4,000K • CRI>80

DLA-8

- 490mmL x 110mm depth
- Base mounting 170mmL x 46mmH

INTEGRAL



- **74 lm/W** • 890 total lm
- 12Watts • 4,000K • CRI>80

DLA-12

- 630mmL x 110mm depth
- Base mounting 170mmL x 46mmH

INTEGRAL



- **73 lm/W** • 1320 total lm
- 18Watts • 4,000K • CRI>80

DLA-18

- 930mmL x 110mm depth
- Base mounting 170mmL x 46mmH

CHROME



DLS-8



DLS-12

INTEGRAL



- **65 lm/W** • 520 total lm
- 8Watts • 4,000K • CRI>80

DLS-8

- 452mmL x 125mm depth
- Base mounting 170mmL x 46mmH

INTEGRAL



- **56 lm/W** • 680 total lm
- 12Watts • 4,000K • CRI>80

DLS-12

- 592mmL x 125mm depth
- Base mounting 170mmL x 46mmH

CHROME

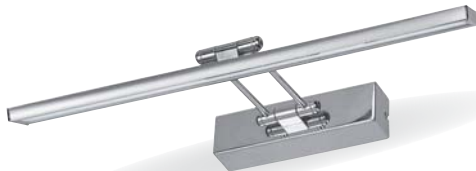

DLT-8



DLT-12

INTEGRAL



- **60 lm/W** • 480 total lm
- 8Watts • 4,000K • CRI>80

DLT-8

- 450mmL x 190mm depth
- Base mounting 170mmL x 46mmH

INTEGRAL



- **60 lm/W** • 720 total lm
- 12Watts • 4,000K • CRI>80

DLT-12

- 570mmL x 190mm depth
- Base mounting 170mmL x 46mmH

T4 Linkable Fluorescent

84lm/W

T4

Lamps Included

F

ta 38°C Max

6400 K

230V-240V

SUPER ENERGY EFFICIENT

Saves 60% more energy than equivalent wattage T8 magnetic ballasted fluorescent

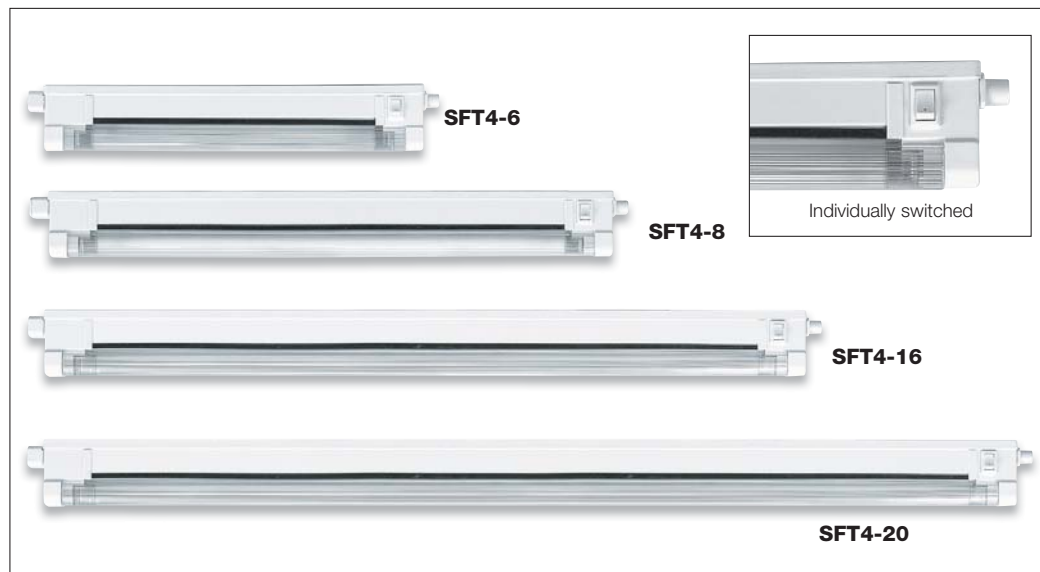

SFT4-6 (6 watts)

SFT4-8 (8 watts)

SFT4-16 (16 watts)

SFT4-20 (20 watts)

SFT4 CONNECTORS

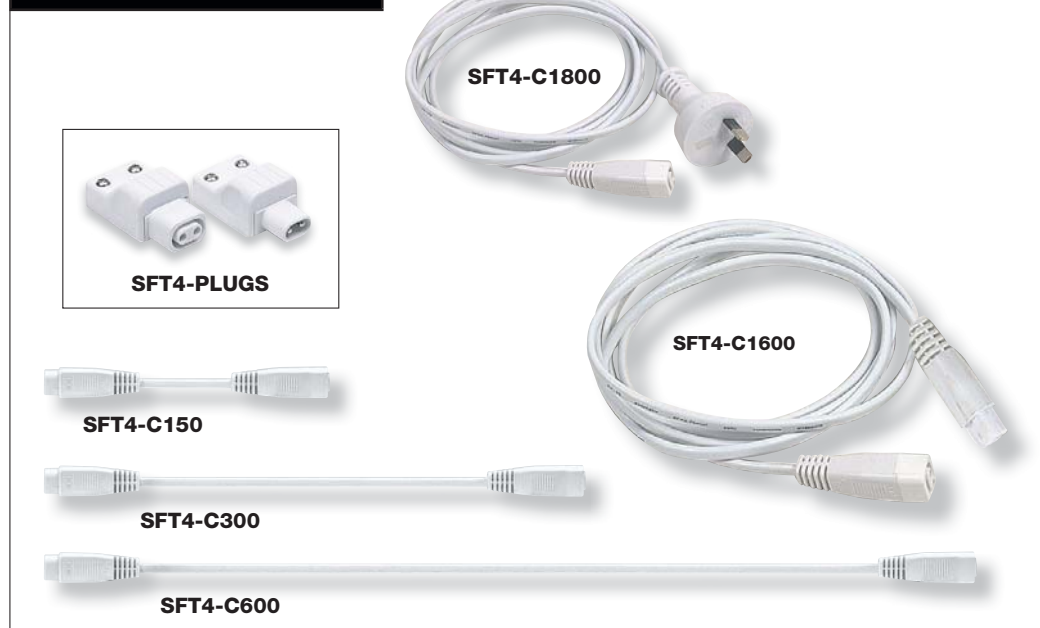

SFT4-C1800
Power supply cord (1800mm)

SFT4-PLUGS
1 pair of re-wireable plugs

SFT4-C1600
• For pre-wire of step or wall lights SUR53-SI
• 1600mm long connector cable

SFT4-C150
Connector cable (150mm)

SFT4-C300
Connector cable (300mm)

SFT4-C600
Connector cable (600mm)

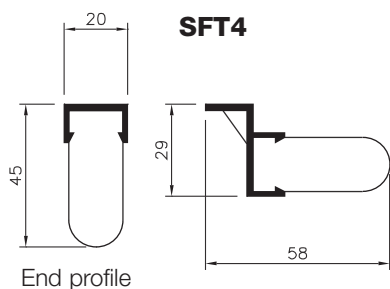

- Fixture lengths including connectors:

6W	278mm
8W	398mm
16W	526mm
20W	625mm

- Australian Approved connector cables NSW 22616
- Directly linkable to provide continuous lines of light.
- Very low heat output makes them ideal for Display Cabinets. Install separately or join with optional cables. Ideal for linking around corners, furniture etc. Small profile.
- When joined fittings can be individually switched
- Long life bulbs T4 = 10,000 hrs
- 6 watt Green or Blue tubes
- Built in Electronic Ballast, high energy efficiency.
- Supplied complete with diffuser.
- Link up Electronic Fluro Strip Lights in any combination you choose to a maximum of 10 units.

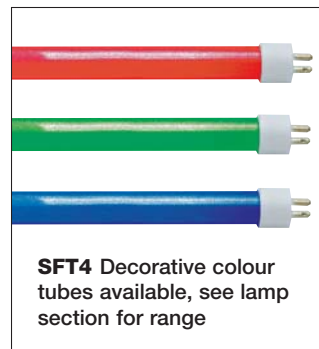

SFT4 Decorative colour tubes available, see lamp section for range

ECG must not be installed on a circuit with inductive loads.

Electronic T5 Fluorescent

84lm/W



SUPER ENERGY EFFICIENT

Saves 60% more energy than equivalent wattage T8 magnetic ballasted fluorescent
Complies with minimum energy performance standards • Individually switched



- SFT5-13** (13 watts)
573mm
- SFT5-21** (21 watts)
905mm
- SFT5-28** (28watts)
1205mm
- SFT5-35** (35watts)
1505mm

SFT5 CONNECTORS

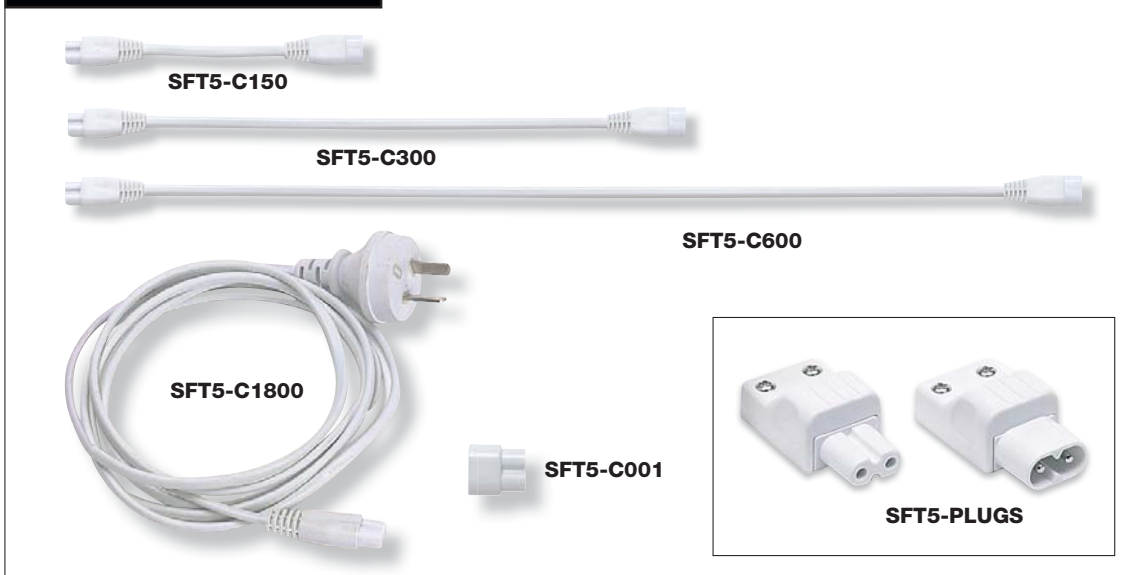

- SFT5-C150**
Connector cable (150mm)
- SFT5-C300**
Connector cable (300mm)
- SFT5-C600**
Connector cable (600mm)
- SFT5-C1800**
(1800mm)
Power supply cord
- SFT5-C001**
Direct Connector
- SFT5-PLUGS**
1 pair of re-wireable plugs.

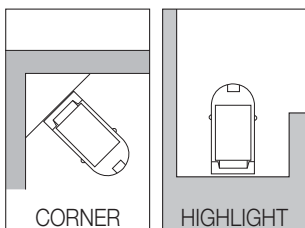
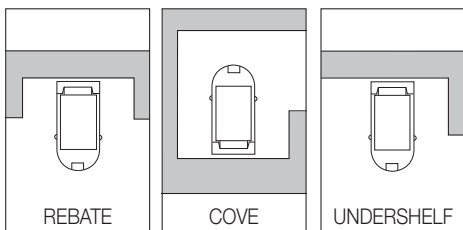
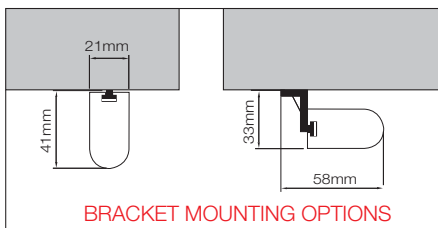

- Provide continuous lines of light.
- Very low heat output makes them ideal for Display Cabinets. Install separately or join with optional cables. Ideal for linking around corners, furniture etc Small profile, low heat.
- Long life bulbs T5 = 10,000 hrs
- Built in Electronic Ballast with very high energy efficiency.
- Supplied complete with diffuser.
- Link up Electronic Fluro Strip Lights in any combination you choose to a maximum of 252w.
- Mounting brackets included.
- Australian Approved connector cables NSW 22616

Coloured tubes available T5

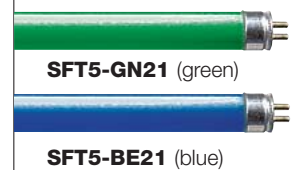

- Daylight tubes available
- SFT5 - DL13** (13watts)
- SFT5 - DL21** (21watts)
- SFT5 - DL28** (28watts)
- Cool White tubes available
- SFT5 - CW13** (13watts)
- SFT5 - CW21** (21watts)
- SFT5 - CW28** (28watts)

ECG must not be installed on a circuit with inductive loads.

Hollywood Lighting

Superb single bar design, ideal for bathroom and personal lighting.
Available in 3, 5 or 7 lamp sizes.

FLUORESCENT
SBFBA-5BWW



• 50 lm/W • 250 total lm
• 5Watts • 2,700K • CRI>80

HOLLYWOOD - SQUARE SERIES

WHITE

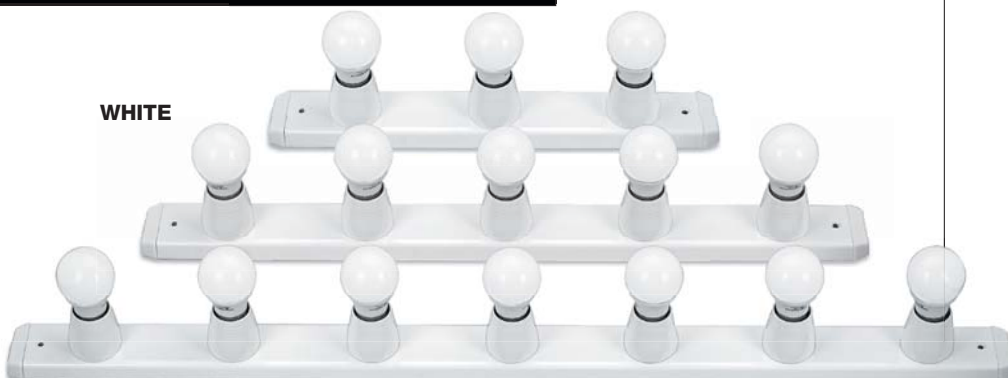

CHROME

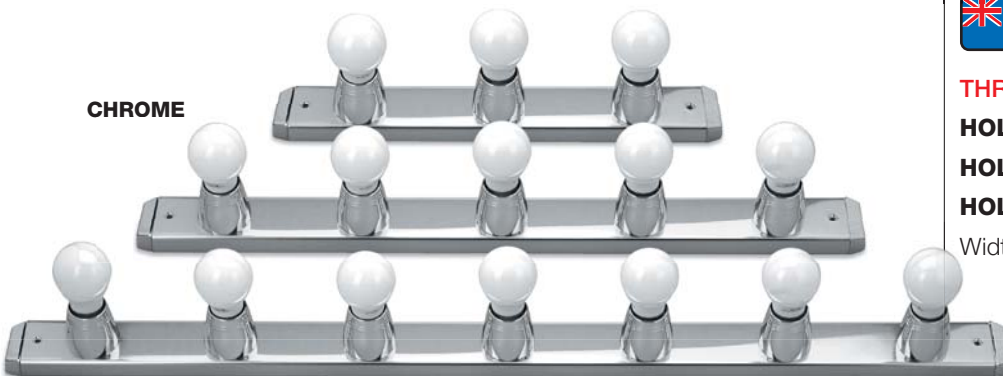

BRASS

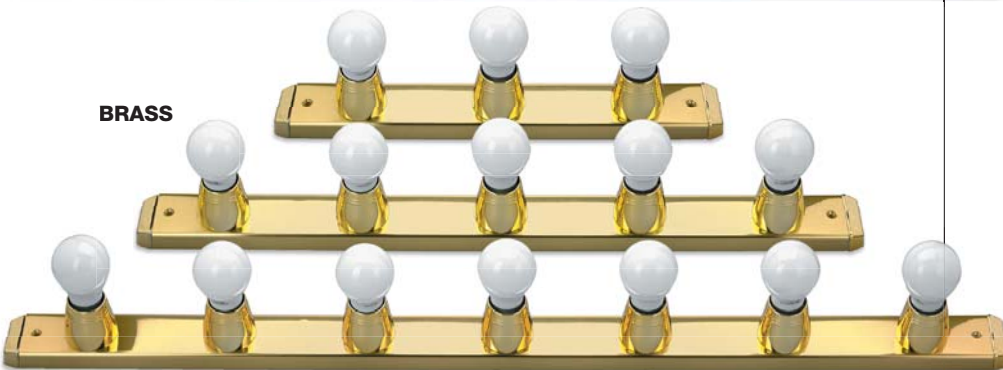

Made in NZ

MAX. 60W

B22

THREE SIZES

HOL3S 3 Light 390mm

HOL5S 5 Light 630mm

HOL7S 7 Light 870mm

Width = 52mm

JOINING ACCESSORIES

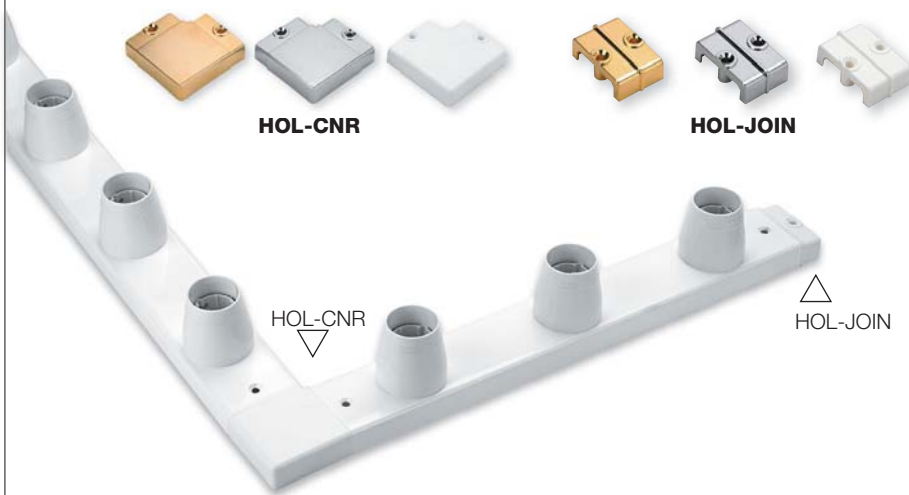

- For continuous length or framing, use linear or corner joiners.
- Joiners available in three colours.
- Complete with jump wires.

Utility and Vanity Lighting



Made in NZ

230V-240V

T8

4000 K

Lamps Included

- Elegant, fluorescent strip fittings - surface mounted or adjustable suspension wire mounting.
- **Electronic Ballast • Instant starts**

MODEL DFSM SURFACE MOUNT



DFSM 36

- 36w
- 1500mmL x 43mmD x 62mmW

DFSM 30

- 30w
- 1200mmL x 43mmD x 62mmW

DFSM 18

- 18w
- 900mmL x 43mmD x 62mmW
- Cable entry 200mm from end

COLOUR RANGE



WHITE



SATIN CHROME

MODEL DF (ADJUSTABLE)



DF 36

DF 36

(1500mm) 36w

DF 30

DF 30

(1200mm) 30w

DF 18

DF 18

(900mm) 18w

- Mounting base 25/40mmH x 660mmL

DF WIRE ACCESSORY

EXAMPLE OF: MODEL-DFSM WITH 2x DF-WIRE

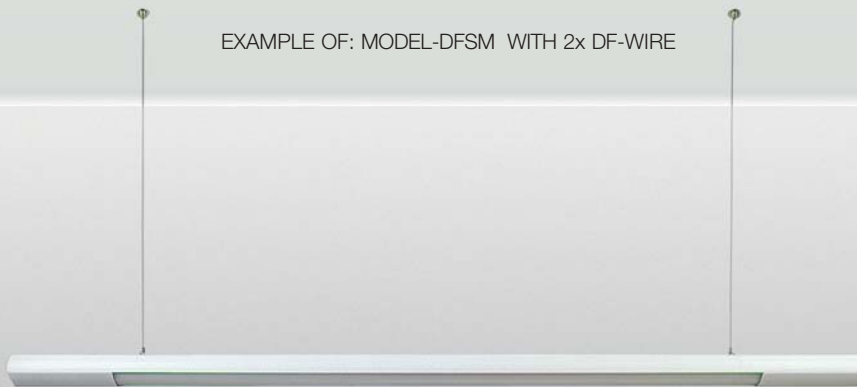

DF-WIRE

- 1x 2 metre Wire with 1x ceiling mount 1x Glider and 2x M10 nuts
- Adjustable lamp mounts- adjustable from zero to 2 metre wire length.
- Attractive chrome 2 piece ceiling mounts. Can be screwed from below or above ceiling.



Rapid Secure Suspension System

- 1.5mmØ steel wire and suspension parts
- All gliders have a safety lock nut to safely and permanently set installation at desired height
- Weight restrictions 15kgs per wire

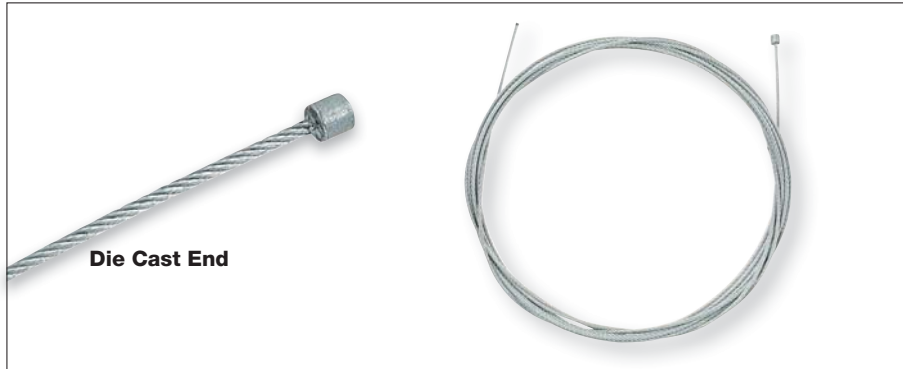

SUSPENSION WIRES

- 1.5mmØ galvanized steel wire with Die Cast end
- Sold in packs of 10
- 1,2,3, and 4 metres lengths available
- RS2001-1** 1 metre
- RS2001-2** 2 metre
- RS2001-3** 3 metre
- RS2001-4** 4 metre



RS2002

- Ceiling mount
- Pack of 10
- 2 piece ceiling mount, to secure screw through from the bottom or bolt from the top through ¼ inch thread.
- Mounting example for where larger fixing area is needed



RS2003

- Recessed glider
- 10mm x 15mm thread
- Pack of 10

RS2004

- Recessed glider
- 10mm x 25mm thread
- Pack of 10



RS2005

- Recessed glider with side cable exit
- 10mm x 15mm thread
- Pack of 10



RS2006

- Display glider with cross hole
- For suspension of vertical lighting products such as LED panels etc
- Pack of 10

Rapid Secure Suspension System



RS2007

RS2007

- Glider with side exit
- Internal 6mmx 6mm thread
- Pack 10



RS2008

RS2008

- Swivel glider
- To hold materials of up to 6mm thick at angle adjacent to horizontal plane
- Pack of 10



RS2009

RS2009

- Glider with side exit
- 3x cable exit
- Pack of 10



RS2010

RS2010

- Glider with side exit
- 4x cable exit
- Pack of 10



RS NUT10

G1453

- Crimplugs for permanent looped ends of suspension wires
- Pack of 100

RS NUT10

- M10 Nut for gliders
- Pack of 10

LED Spotlights

230V-240V

- Integrated LED modules
- High Power LED spotlights with wide 50° beam angle, with lots of extra spill light perfect for general room lighting
- 3,000k Warm White colour temperature
- Integral driver supplied in base.

LSLC SERIES



LSLC-P1-CH

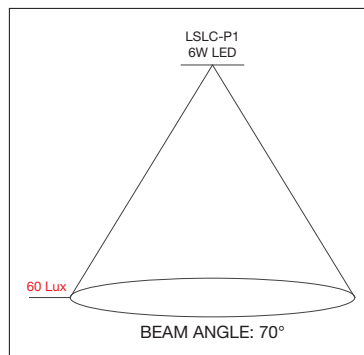

LSLC-B2-CH



LSLC-B3-CH



LSLC-B4-CH

DISTANCE

LUX

DISTANCE	LUX
1m	350 lux
1.5m	165 lux
2.4m	60 lux

INTEGRAL



- 88 lm/W • 528 total lm
- 6Watts • 3,000K • CRI>80 • 50° Beam

LSLC-P1-CH

- Chrome base with Triplex Acid glass shades
- 80mmØ Shade
- 100mmØ Mounting base

INTEGRAL



- 88 lm/W • 1056 total lm
- 2x 6Watts • 3,000K • CRI>80 • 50° Beam

LSLC-B2-CH

- Chrome base with Triplex Acid glass shades
- 80mmØ Shade
- 120mmØ Mounting base
- 362mm Length

INTEGRAL



- 88 lm/W • 1584 total lm
- 3x 6Watts • 3,000K • CRI>80 • 50° Beam

LSLC-B3-CH

- Chrome base with Triplex Acid glass shades
- 80mmØ Shade
- 120mmØ Mounting base
- 540mm Length

INTEGRAL



- 88 lm/W • 2112 total lm
- 4x 6Watts • 3,000K • CRI>80 • 50° Beam

LSLC-B4-CH

- Chrome base with Triplex Acid glass shades
- 80mmØ Shade
- 120mmØ Mounting base
- 762mm Length

LED Spotlights

NEW

230V-240V

- Integrated LED modules
- High Power LED spotlights with wide 50° beam angle, with lots of extra spill light perfect for general room lighting
- 3,000k Warm White colour temperature
- Integral driver supplied in base
- Wire direct to Mains.

LSLT SERIES

Switch on side of base



LSLT-P1-CH

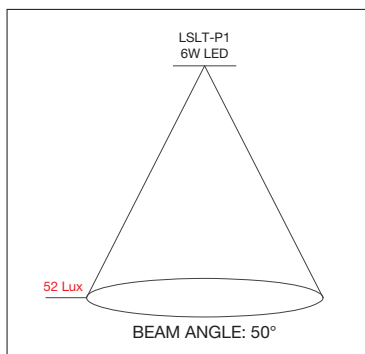

LSLT-B2-CH



LSLT-B3-CH

DISTANCE	LUX
1m	350 lux
1.5m	165 lux
2.4m	52 lux

INTEGRAL



- 88 lm/W • 528 total lm
- 6Watts • 3,000K • CRI>80 • 50° Beam

LSLT-P1-CH

- Chrome base with Acid glass shade
- Individually switched
- Ideal as a bedside light
- 60mmØ Shade
- 100mm square mounting base

INTEGRAL



- 88 lm/W • 1056 total lm
- 2x 6Watts • 3,000K • CRI>80 • 50° Beam

LSLT-B2-CH

- Chrome base with Triplex Acid glass shades
- 60mmØ Shade
- 260mmL x 50mmW mounting base

INTEGRAL



- 88 lm/W • 1584 total lm
- 3x 6Watts • 3,000K • CRI>80 • 50° Beam

LSLT-B3-CH

- Chrome base with Acid glass shades
- 60mmØ Shade
- 390mmL x 50mmW mounting base

FLUSH BOX MOUNT

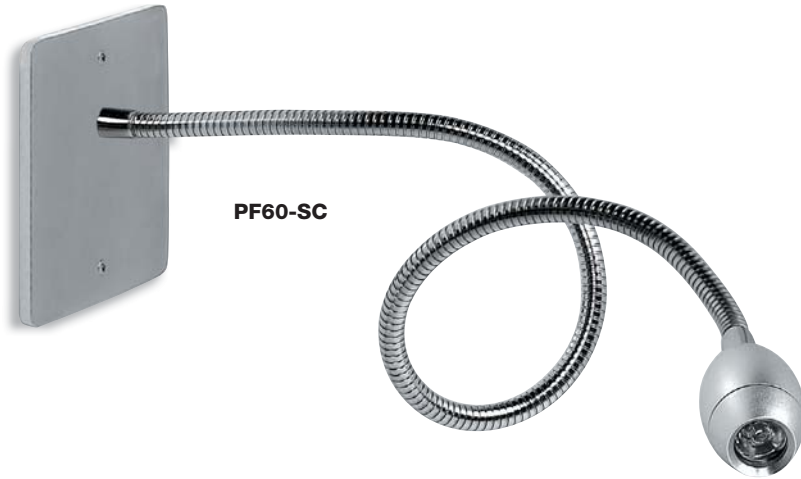

INTEGRAL



- **80 lm/W** • 80 total lm
- 1Watts • 3,200K • CRI>80 • 26° Beam

PF60-SC

- Flexible arm LED bedside light
- Satin Chrome
- Mounting plate 75mmW x 120mmH
- Mount onto standard flush box
- 650mm long stem including head
- LED driver included
- 1025 lux at 0.5 metre 280 lux at 1 metre

SURFACE MOUNT



INTEGRAL



- **80 lm/W** • 240 total lm
- 3Watts • 3,000K • CRI>80 • 25° Beam

PF418-SI

- CREE LED technology
- Flexible arm LED bed side light
- Satin Chrome
- Mounting base 72mmW x 80mmH
- 350mm long stem including head
- LED driver included
- Switch on base
- 1440 lux at 0.5 metres
- 444 lux at 1 metre

High Power LED Spotlights

NEW

LED HIGH POWER SPOTS



SC705-WH



SC705-BL

INTEGRAL



- **78 lm/W** • 1,100 total lm
- 14Watts • 3,000K • CRI>90 • 20° Beam

SC705

- 360° swivel at base, head tiltable through 90°
- Driver integral in body
- Base 80mmØ
- Head 63mmØ x 158mmL



SC706-WH



SC706-BL

INTEGRAL



- **80 lm/W** • 1,850 total lm
- 23Watts • 3,000K • CRI>90 • 20° Beam

SC706

- 360° swivel at base, head tiltable through 95°
- Driver integral in body
- Base 80mmØ
- Head 85mmØ x 153mmL

40° OPTIONAL REFLECTORS



SC4005



SC4006

SC4005

- 40° degree optional reflector for SC705

SC4006

- 40° degree optional reflector for SC706

SH Series Spotlights

- Mains voltage • No Transformer required • Contemporary compact design

SH-B2 Lights individually switched Base 380mmL x 40mmW

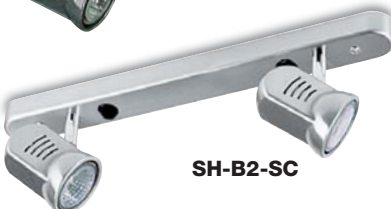
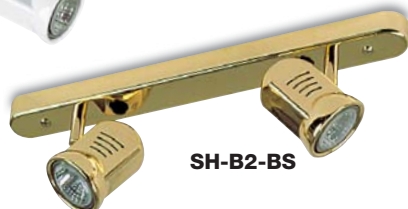

LED
GU10-HPLED-WH



- **60lm/W** • 300 total lm
- 5Watts • 4,000K • CRI>80 • 30° Beam

LED
GU10D-5LED-WW



- **68lm/W** • 340 total lm • Dimmable
- 5Watts • 3,000K • CRI>80 • 30° Beam

GU 10 MAX. 50W 230V-240V

Base 480mmL x 40mmW



Base 120mmØ x 895mmL



SH Series Spotlights

- Mains voltage • No Transformer required • Contemporary compact design



LED
GU10-HPLED-WH

- **60 lm/W** • 300 total lm
- 5Watts • 4,000K • CRI>80 • 30° Beam



LED
GU10D-5LED-WW

- **68 lm/W** • 340 total lm • Dimmable
- 5Watts • 3,000K • CRI>80 • 30° Beam



GU 10 MAX. 50W 230V-240V

SH-P3
• Base 230mmØ



GU 10 MAX. 50W 230V-240V

SH-P2
• Base 175mmØ



GU10 Spotlights

LED
GU10-HPLED-WH



• **60lm/W** • 300 total lm
• 5Watts • 4,000K • CRI>80 • 30° Beam

LED
GU10D-5LED-WW



• **68lm/W** • 340 total lm • Dimmable
• 5Watts • 3,000K • CRI>80 • 30° Beam

SK SERIES



SK-P1-SC

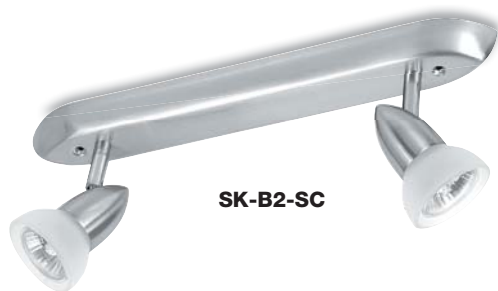

SK-B2-SC



SK-B3-SC

GU 10 **MAX. 50W** **230V-240V**

- Clean European inspired design
- Combination glass/metal construction
- Adjustable directional heads
- Acid glass with Satin Chrome

SK-P1-SC
Base - 85mmW x 110mmL

SK-B2-SC
Base - 380mmL x 53mmW

SK-B3-SC
Base - 560mmL x 53mmW

Double Insulated GU10 Spotlights



- Advanced Resin Construction Halogen Spotlights, White or Silver Grey

SY SERIES



SY-P1-WH



SY-P1-SG



SY-P3-WH



SY-B2-WH

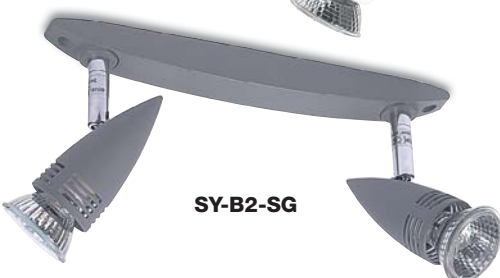

SY-B2-SG



SY-P3-SG

GU 10 **MAX. 50W** **230V-240V**

SY-P1
Base 85mmØ

SY-B2
Base 260mmL x 30mmW

SY-P3-SG
Base 260mmØ

Bed Side Task Light

FLEXIBLE SPOTS

Dimmable



SA-P1-CH



SA-B2-CH

HALOGEN G9-40F



- 10 lm/W • 400 total lm • Dimmable
- 40Watts • 3,000K • CRI>100



SA-P1-CH

- Chrome and opal glass
- With dimmer switch
- 100mmL x 50mmW mounting

SA-B2-CH

- Chrome and opal glass
- With 2x dimmer switches
- 270mmL x 50mmW mounting

SG SERIES



SG-P1-CH

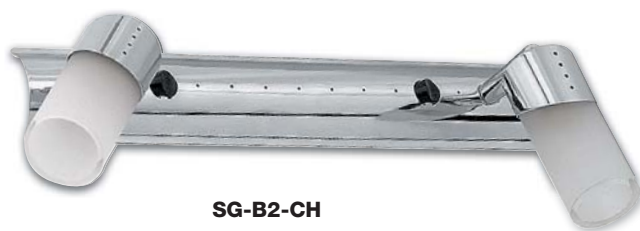

SG-B2-CH

LED G9-3WLED-WW



- 66 lm/W • 198 total lm
- 3Watts • 3,000K • CRI>80 • 360° Beam

HALOGEN G9-40F



- 10 lm/W • 400 total lm • Dimmable
- 40Watts • 3,000K • CRI>100



SG-P1-CH

- Chrome
- Backplate 100mm x 50mm

SG-B2-CH

- Chrome
- Backplate 310mm x 50mm
- Acid glass tube shades (individually switched)

TK Series Tracks & Fittings

TK TRACKS

- 230V-240V power supply
- Tracks include 1 x TK-END and 1 x end cap



Spotlight Track Black
TK-2000-BL (2 metres)
TK-1000-BL (1 metre)

Spotlight Track Silver
TK-2000-SI (2 metres)
TK-1000-SI (1 metre)

Spotlight Track White
TK2000-WH (2 metres)
TK1000-WH (1 metre)

	Style	Amps	No. of Heads
LED	9Watt	0.06	60
LED	15Watt	0.07	50
12volt	50Watt	0.22	30
GU10	50Watt	0.22	30
R80	100Watt	0.42	16
PAR30	100Watt	0.42	16
PAR38	150Watt	0.64	10

Fitting the Lamp Heads

- Maximum capacity of track is 7 AMPS in one run of connected track
- For number of heads per run see chart (right)
- TK heads are double insulated

TK TRACK ACCESSORIES



TK-CROSS-WH



TK-CROSS-BL



TK-CORNER-WH



TK-CORNER-SI



TK-CORNER-BL



TK-TEE-WH



TK-TEE-SI



TK-TEE-BL



TK-JOIN-WH



TK-JOIN-SI



TK-JOIN-BL



TK-END-WH



TK-END-SI



TK-END-BL

Use to join multiple track sections using flexible cable

Examples of track joiner arrangements

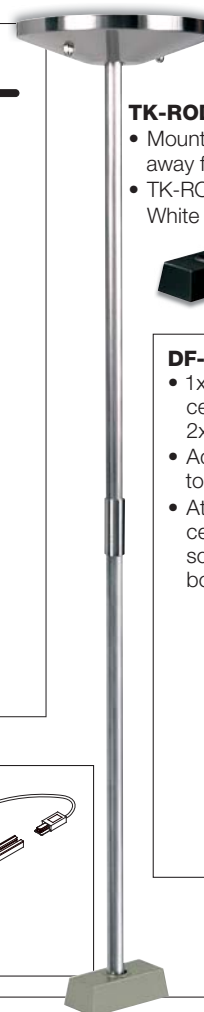
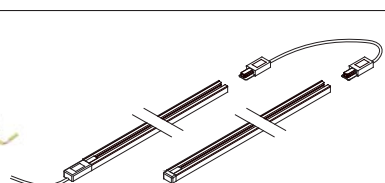
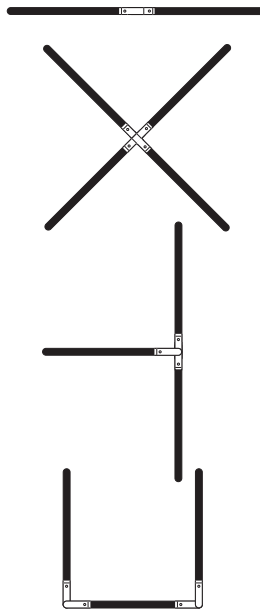

TK-ROD-SC Satin Chrome

- Mounts track 300mm or 630mm away from ceiling
- TK-ROD comes with satin chrome, White & Black track caps



DF-WIRE

- 1x 2 metre Wire with 1x ceiling mount 1x Glider and 2x M10 nuts
- Adjustable length from zero to 2 metres.
- Attractive chrome 2 piece ceiling mounts. Can be screwed from below or bolted from above ceiling.



TK Series Track Spotlights

MR16 12v MAX 50W

Metal swivel arm, quality powder coating and wide range of styles and applications.



LED

TKL401
1x 9 watt LED
Warm White
880 lumens
38° beam angle
CRI 80



LED

NEW

TKL503-SI
1 x 15Watt
LED Warm White
1028 lumens
20° beam angle
CRI 80



TK21

MR16

HALOGEN
MRE16-35-D38



• 15lm/W • 525 total lm • Dimmable
• 35Watts • 3,000K • CRI>100 • 38° Beam



LED
MR16-HPLED-WH



• 80lm/W • 480 total lm
• 6Watts • 3,000K • CRI>80 • 38° Beam

TK51



Lamps
Included

RL111

TK206

Supplied with Superlux RL111
which accepts 12volt capsule
lamps.

Powerful Focused Beam



MAX. 150W **230V-240V** **PAR 38**

TK121

NEW

LED
PAR38-12WLED-WH

E27



• 80 lm/W • 960 total lm
• 12Watts • 3,000K • CRI>80 • 63° Beam

Rope Light Kitsets

- All hooks & fittings incl. adjustable turnbuckles etc • Max span 6.5 metres*
- Transformer included • Rope cable is 2.2mm² tinned multistrand 3mmØ over clear sheathing

HALOGEN
MR16-20-D38
Included



- 10 lm/W • 200 total lm • Dimmable
- 20Watts • 3,000K • CRI>100 • 38° Beam

LED
MR16-HPLED-WH



- 80 lm/W • 480 total lm
- 6Watts • 3,000K • CRI>80 • 38° Beam



SV-Rope5-98

SV-Rope3-92

SV-Rope5-23

SV-Rope5-58

5x **12v**  **MR16**
 20W

- SV-Rope5-98**
- 5x Heads
 - 14 metre wire

3x **12v**  **MR16**
 35W

- SV-Rope3-92**
- 3x Heads
 - 14 metre wire

5x **12v**  **MR16**
 20W

- SV-Rope5-23**
- 5x Heads
 - 14 metre wire
 - Rod 240mm long

5x **12v**  **MR16**
 20W

- SV-Rope5-58**
- 5x Heads
 - 14 metre wire
 - Extreme adjustability for an accurate aim

OPTIONAL ACCESSORIES FOR ROPE LIGHTS



SV-Disk-BE
 Optional blue disk accessory for SV-Rope 5-23, 5-98,

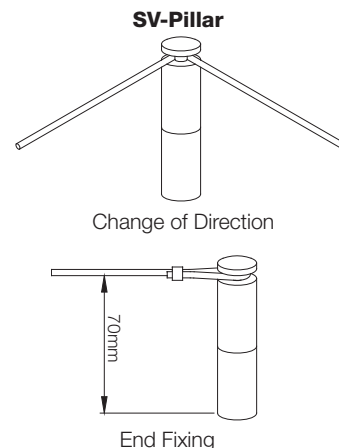
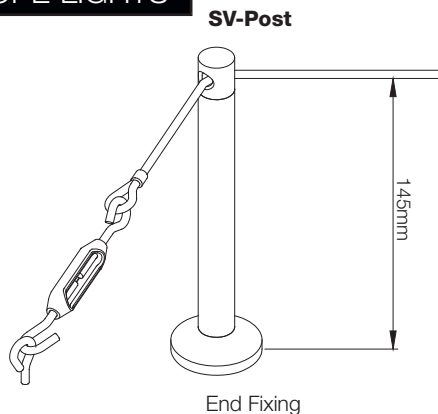

Mains Voltage Track Spotlights

- Mains voltage, no transformer complications
- Modern Satin Chrome with silver track
- A variety of light sources
- Many track configurations possible
- Track capacity 16amps

LED
GU10-HPLED-WH



• **60 lm/W** • 300 total lm
• 5Watts • 4,000K • CRI>80 • 30° Beam

LED
GU10D-5LED-WW



• **68 lm/W** • 340 total lm • Dimmable
• 5Watts • 3,000K • CRI>80 • 30° Beam

HALOGEN
GU10-50-A



• **10 lm/W** • 500 total lm • Dimmable
• 50Watts • 3,000K • CRI>100 • 36° Beam



TE100-SC

TE101-SC
Shade 85mmØ

TE103-SC

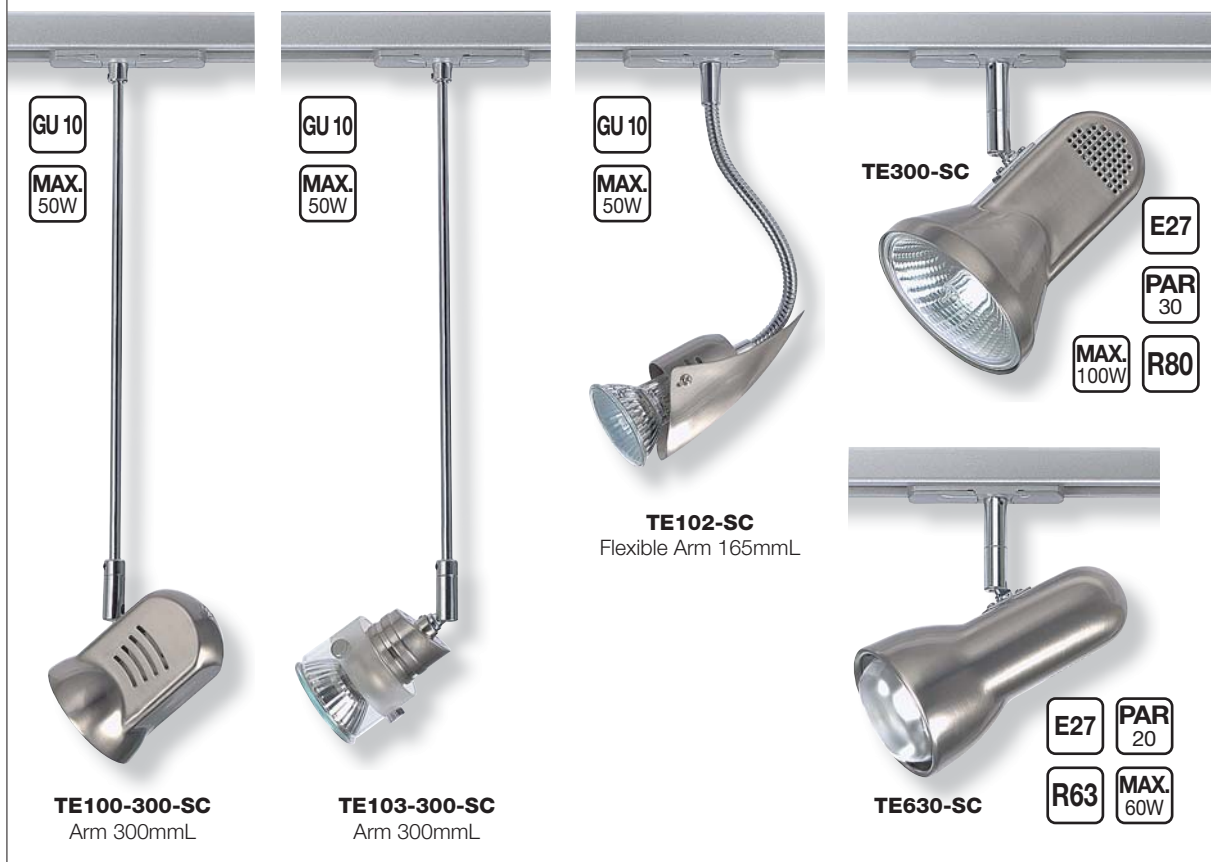

GU 10
MAX. 50W

GU 10
MAX. 50W

GU 10
MAX. 50W

TE102-SC
Flexible Arm 165mmL

TE300-SC

E27
PAR 30
MAX. 100W
R80

TE100-300-SC
Arm 300mmL

TE103-300-SC
Arm 300mmL

TE630-SC

E27
PAR 20
R63
MAX. 60W

230V-240V

GU 10
MAX. 50W

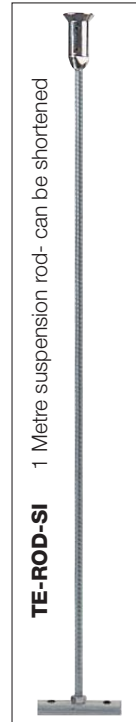

TE ACCESSORIES

- Track capacity 16 amps

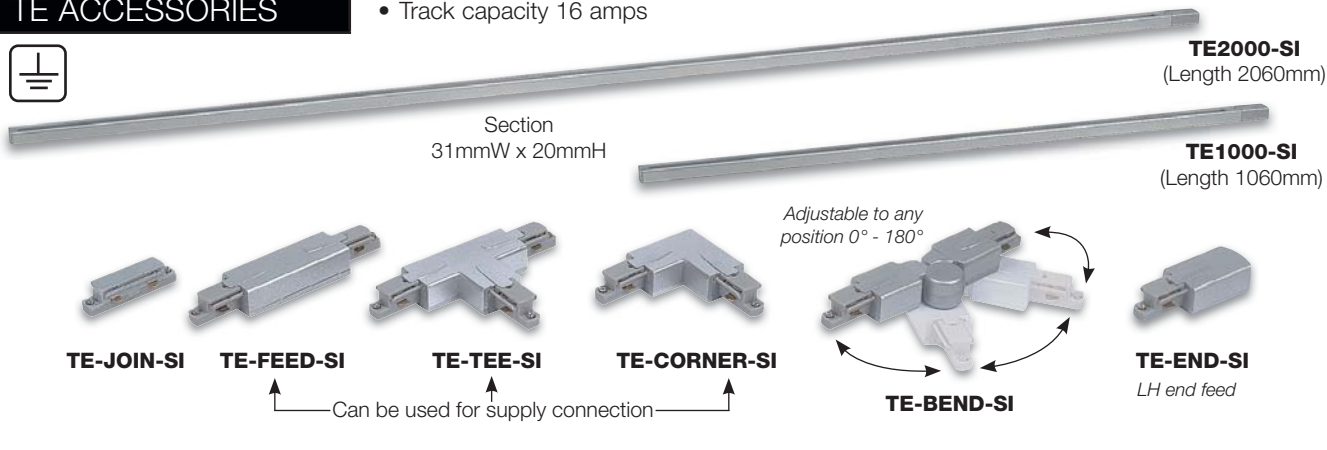



787-10

INTEGRAL



• **72 lm/W** • 720 total lm
• 10Watts • 4,100K • CRI>80

787-10

- Matt Opal Lens
- 300mmØ x 70mmH
- Twist lock lens
- Wire direct to mains power supply
- Easy to wire large terminal block



787-14

INTEGRAL



• **70 lm/W** • 980 total lm
• 14Watts • 4,100K • CRI>80

787-14

- Matt Opal Lens
- 360mmØ x 85mmH
- Twist lock lens
- Wire direct to mains power supply
- Easy to wire large terminal block

GLASS & CHROME CEILING LIGHTS



CL2257-CH



LED array and easy to wire terminal block

INTEGRAL LED

- 90 lm/W • 1080 total lm
- 12Watts • 3,000K • CRI>80

CL2257-CH

- Silver base with Chrome clasps
- Frosted glass
- 320mmØ x 70mmD
- Driver included in base

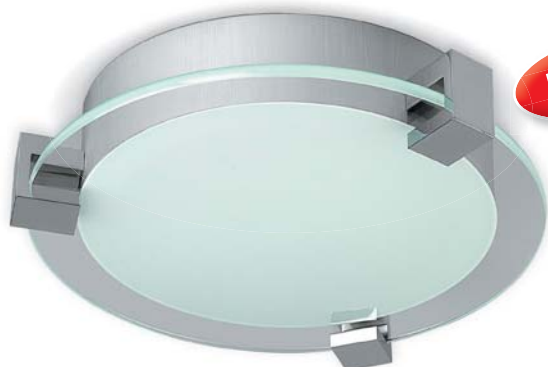

CL2220-CH

INTEGRAL LED

- 90 lm/W • 1800 total lm
- 20Watts • 3,000K • CRI>80

CL2220-CH

- Silver base with Chrome clasps
- Frosted glass
- 420mmØ x 70mmD
- Driver included in base

HALF EDGE TRIM



CL5003-8

INTEGRAL LED

- 100 lm/W • 850 total lm
- 8.5Watts • 3,000K • CRI>80

CL5003-8

- Frosted glass, with chrome edge detail
- 8.5Watt, LED ceiling light similar to 100 watt incandescent
- Integral driver in base
- 300mmØ x 90mmD
- Integral driver in base

LED Glass Ceiling & Wall Lights

NEW

230V-240V

- Samsung brand LED technology
- Acid Glass Shades • Satin Chrome Claws • Integral Electronic Driver
- Wire straight to mains • Integral LED COB

CEILING LIGHTS



CL320-24

INTEGRAL

LED

- **98 lm/W** • 2352 total lm
- 24Watts • 3,000K • CRI>80

CL320-24

- 450mmØ x 114mmD

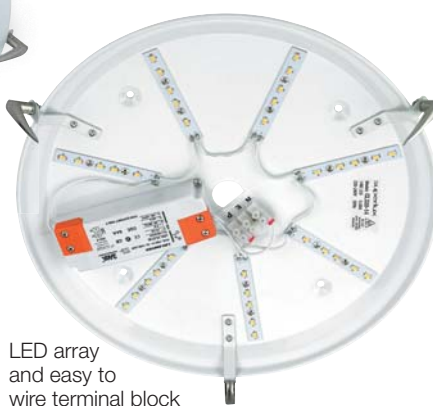

LED array and easy to wire terminal block



CL320-14

INTEGRAL

LED

- **98 lm/W** • 1,372 total lm
- 14Watts • 3,000K • CRI>80

CL320-14

- 350mmØ x 100mmD

Optional Extras



Claw - WH
(set of 3)



Claw - BS
(set of 3)

WALL LIGHT



WL320-8

INTEGRAL

LED

- **98 lm/W** • 784 total lm
- 8Watts • 3,000K • CRI>80

WL320-8

- 340mmØ x 100mmD

Contemporary LED Wall Lights

METAL WALL LIGHTS

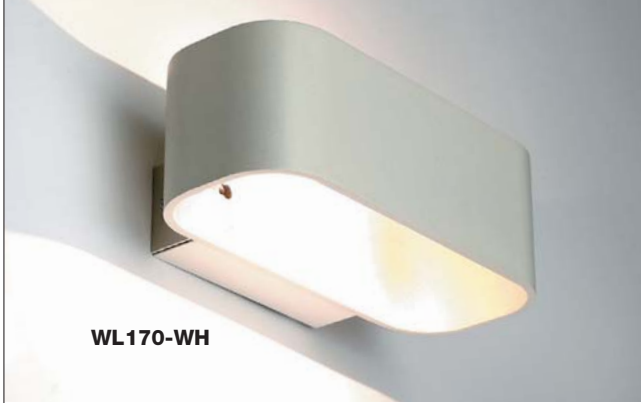

WL170-WH



WL170-BL



WL167-SI



WL167-WH

INTEGRAL



- 70 lm/W • 350 total lm
- 5Watts • 3,000K • CRI>80

WL170

- 5 Watt high power integral LED similar light output to a 50 Watt halogen
- Extruded aluminium with white or black paint finish
- 188mmW x 67mmH x 105mmD
- Driver included in base

INTEGRAL



- 70 lm/W • 350 total lm
- 5Watts • 3,000K • CRI>80



WL167

- CUBE LED Wall Light
- 100mmW x 100mmD x 62mmH
- 5 Watt High Power integral LED similar light output to 50 Watt halogen
- Extruded aluminium with white or silver paint finish
- Driver included in base

Circular Fluorescent

5000 K CIRC 4 PIN 22W 32W 40W 72W Lamps Included

- Acrylic lenses available in two attractive finishes and a selection of four wattages.
- 72 watt models offer multiple switching capabilities for 3 light levels 32, 40 & 72 watts

SUPERLUX 720 SERIES SAVES ENERGY



For same lumens output !
45%* saving over Magnetic ballasted fluorescent
65%* over incandescent light sources

- Instant start, no flickering.
- 5000k triphosphors tubes brilliant colour true to life.
- Quality acrylic lenses allow more transmission of light than glass better utilising available luminous flux.
- Electronic ballasts extend lamp life.
- The affordable electronic solution.

*An average % based on overall 720 series range.

720 SERIES OPAL LENS



- 720-22** (22 watt)
 • 250mmØ x 86mmH
- 720-32** (32 watt)
 • 350mmØ x 107mmH
- 720-40** (40 watt)
 • 450mmØ x 116mmH
- 720-72** (72 watt)
 • 450mmØ x 116mmH

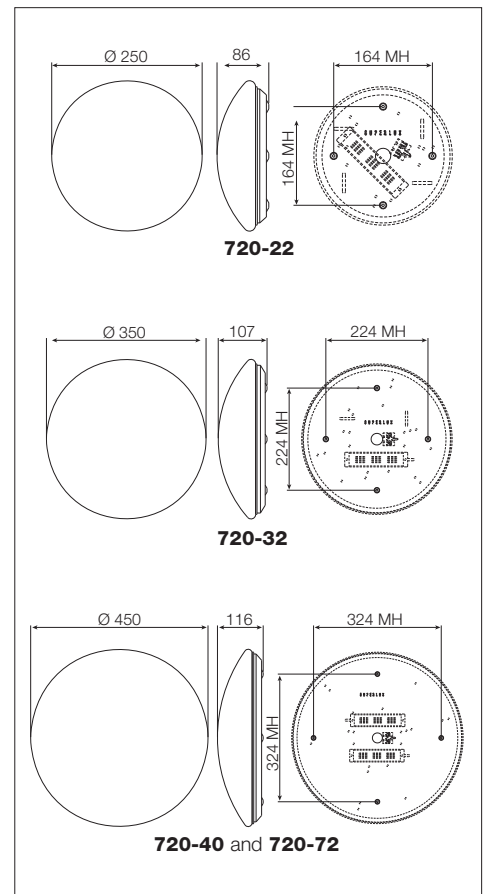

721 SERIES ALABASTER LENS



- 721-22** (22 watt)
 • 250mmØ x 86mmH
- 721-32** (32 watt)
 • 350mmØ x 107mmH
- 721-40** (40 watt)
 • 450mmØ x 116mmH
- 721-72** (72 watt)
 • 450mmØ x 116mmH

724 SERIES SQUARE LENS



32W 5000 K

- 724-32**
 • Opal Lens
 • 390mm Square x 85mmH
 • 1760 lumens



Energy efficient
Electronic Ballast and Lamp included
 Longer lamp life than standard Self Ballasted
 Fluorescent lamps and higher energy efficiency

720/721 Series Trims

Metal trims available to fit Superlux circular fluorescent fittings

SLIMLINE METAL TRIMS

TRIM - 22 - BC
BS
WH

TRIM - 32 - BC
BS
WH

TRIM - 40 - BC
BS
WH



Brass

White

Brushed Chrome

3 sizes:

- Trim - 22Watt
- Trim - 32Watt
- Trim - 40Watt

When purchasing:

1. Choose the wattage of circular fittings. 22Watt, 32Watt, 40Watt or 72Watt.
2. Choose lens design: Opal, Alabaster, Sculptured Swirl.
3. Choose trim colour: Brass, White, Brushed Chrome.

EXAMPLES OF METAL TRIMS WITH FITTINGS

 Brass Trim on Opal fitting	 Brushed Chrome Trim on Alabaster fitting	 White Trim on Opal fitting
 Brass Trim on Alabaster fitting	 Brushed Chrome Trim on Alabaster fitting	 White Trim on Alabaster fitting

CURVED METAL TRIMS

TRIM - C22 - BC
BS
WH

TRIM - C32 - BC
BS
WH



Brass

White

Brushed Chrome

2 Sizes:

- Trim - 22Watt
- Trim - 32Watt

When purchasing:

1. Choose the wattage of circular fittings. 22Watt, 32Watt.
2. Choose lens design opal, Alabaster, sculptured swirl.
3. Choose trim colour brass, white, brushed chrome.

EXAMPLES OF METAL TRIMS WITH FITTINGS

 Brass trim on Opal fitting	 Brushed Chrome trim on Opal fitting	 White trim on Opal fitting
 Brass trim on Alabaster fitting	 Brushed Chrome trim on Alabaster fitting	 White trim on Alabaster fitting



WL2109-S



WL2109-L



Energy efficient

Electronic Ballast and Lamp included

Longer lamp life than standard Self Ballasted Fluorescent lamps and higher energy efficiency

3x **18W** **PL-L** **Lamp**
4 PIN Included

WL2109-S

- Chrome
- Acid glass
- 400mm sq x 56mmD
- Wall or Ceiling mount
- Electronic control gear included
- 3564 lumens

2x **36W** **PL-L** **Lamp**
4 PIN Included

WL2109-L

- Chrome
- Acid glass
- 210mmW x 600mmL x 55mmD
- Wall or Ceiling mount, Horizontal or Vertical
- Electronic control gear included
- 4752 lumens

FLUORESCENT
PLCQ-26WW *Included*

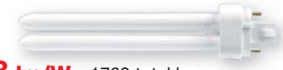

- 68 lm/W • 1768 total lm
- 26Watts • 2,700K • CRI>82

FLUORESCENT
PLCQ-18WW *Included*



- 68 lm/W • 1224 total lm
- 18Watts • 2,700K • CRI>82

Compact Fluorescent Ceiling Lights

OPAL LENS



CL207-52



CL207-36

PL-C
4 PIN

52W

G24
q-3

CL207-52

- 405mmØ x 80mmH
- 2x 26 watts
- 3,000k colour temperature
- Acrylic lens
- High power factor 0.98 electronic ballast included

36W

PL-C
4 PIN

G24
q-3

CL207-36

- 285mmØ x 75mmH
- 2x 18 watts
- Acrylic lens
- High power factor 0.95 electronic ballast included

SILVER TRIM



CL205-52



CL205-36

52W

PL-C
4 PIN

G24
q-3

CL205-52

- Trim prevents light spill across ceiling
- 410mmØ x 110mmH
- 2x 26 watts
- 3,000k colour temperature
- Acrylic lens
- High power factor 0.98 electronic ballast included

36W

PL-C
4 PIN

G24
q-3

CL205-36

- Trim prevents light spill across ceiling
- 300mmØ x 90mmH
- 2x 18 watts
- Acrylic lens
- High power factor 0.95 electronic ballast included



Wall Lights

ACID GLASS WALL LIGHTS

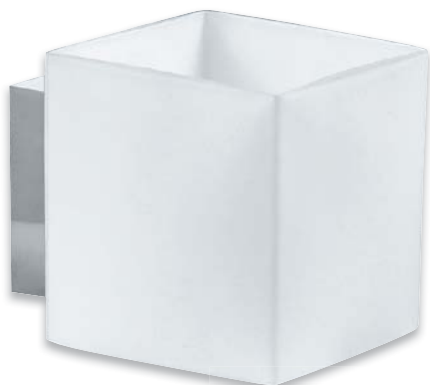

WLC2161



WLS2155-WH

LED G9-3WLED-WW



- 66 lm/W • 198 total lm
- 3Watts • 3,000K • CRI>80 • 360° Beam

HALOGEN G9-50F



- 10 lm/W • 500 total lm • Dimmable
- 50Watts • 3,000K • CRI>100



WLC2161

- Chrome base
- 90mm Square shade
- 60mmH x 50mmW mounting base



WLS2155-WH

- Chrome base
- 230mmW x 110mmD
- Mounting 120mmW x 70mmH

UP AND DOWN CUBE LIGHT



WL3721

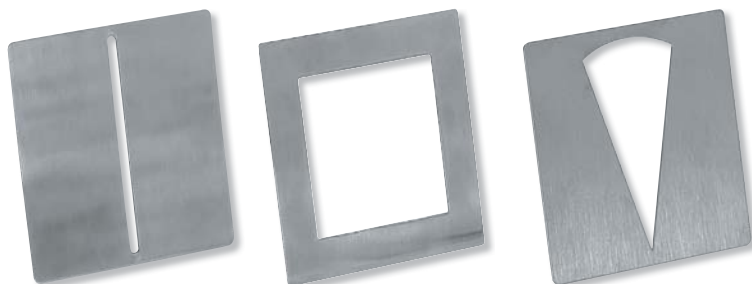

WL3721

- 3x Sets of Magnetic light pattern templates supplied
- Brushed Aluminium
- 100mm Square
- Mounting 75mmØ
- Templates at top and bottom

Minimalist Glass Wall Lights

PETITE



WLS9287-WH



WLS9287-BL



WLS9287-RD

HALOGEN G9-50F



- **10 lm/W** • 500 total lm • Dimmable
- 50Watts • 3,000K • CRI>100

LED G9-3WLED-WW



- **66 lm/W** • 198 total lm
- 3Watts • 3,000K • CRI>80 • 360° Beam

MAX.
50W

G9

230V-
240V

WLS9287

- Up and Downlighting effect
- 110mmØ x 140mmH
- Simple elegant design
- Red and White are translucent
- Black is opaque
- Gloss finish
- Square chrome mounting
- Base 53mm x 83mm

GRAND



WLL9287-WH



WLL9287-BL



WLL9287-RD

MAX.
50W

G9

230V-
240V

WLL9287

- Up and Downlighting effect
- 110mmØ x 240mmH
- Simple elegant design
- Red and White are translucent
- Black is opaque
- Gloss finish
- Square chrome mounting
- Base 53mm x 83mm

Plaster Wall Lights



• Paintable to suit your decor



WL4274

E14 **MAX. 40W**

WL4274

• 245mmH x 95mmW x 90mmD



WL8436

G9 **MAX. 40W**

WL8436

• 146mmH x 110mmW x 125mmD



WL8834

INTEGRAL



• **80 lm/W** • 640 total lm
• 8Watts • 3,000K • CRI>80

WL8834

• 150mm Sq x 46mmD



WL8447

INTEGRAL



• **80 lm/W** • 240 total lm
• 3Watts • 3,000K • CRI>80

WL8447

• 155mmØ x 60mmD

LED
CANC-3SEWW



• **100 lm/W** • 300 total lm
• 3Watts • 3,000K • CRI>80 • 270° Beam

FLUORESCENT
SBFSP-7SEWW



• **50 lm/W** • 350 total lm
• 7Watts • 2,700K • CRI>80

G9

HALOGEN
G9-25F



• **10 lm/W** • 250 total lm • Dimmable
• 25Watts • 3,000K • CRI>100

LED
G9-3WLED-WW



• **66 lm/W** • 198 total lm
• 3Watts • 3,000K • CRI>80 • 360° Beam

Picture & Mirror Lighting

Enhance your prints, paintings and decor highlights



INTEGRAL



- 60 lm/W • 300 total lm
- 5Watts • 3,000K • CRI>80

P2984

- Switch on base
- 380mmL x 110mmD

Plaster Wall Lights

European plain plaster wall lights. Can be painted to suit your decor.



WL1602

WL1606

E27 **MAX. 60W** **230V-240V**

WL1602

130mmH x 280mmW x 140mmD

WL1606

110mmH x 355mmW x 110mmD

E27

LED

GLSD-6EWW



- 75 lm/W • 450 total lm • Dimmable
- 6Watts • 3,000K • CRI>81 • 270° Beam

FLUORESCENT

SBFSP-14EWW



- 60 lm/W • 840 total lm
- 14Watts • 2,700K • CRI>80

Euro Wall Lights



E14 **MAX. 60W** **230V-240V**

- WL-611**
- 280mmH x 115mmW x 70mmD
 - Mounting base 157mmH x 77mmW

2x **E14** **MAX. 60W** **230V-240V**

- WL-621**
- 400mmH x 120mmW x 70mmD
 - Mounting base 157mmH x 77mmW

FLUORESCENT
SBFSP-7SEWW



- **50 lm/W** • 350 total lm
- 7Watts • 2,700K • CRI>80

LED
CANC-3SEWW



- **100 lm/W** • 300 total lm
- 3Watts • 3,000K • CRI>80 • 270° Beam

Glass Wall & Ceiling Lights



LED
GLSD-6EWW



- **75 lm/W** • 450 total lm • Dimmable
- 6Watts • 3,000K • CRI>81 • 270° Beam

FLUORESCENT
SBFSP-14EWW



- **60 lm/W** • 840 total lm
- 14Watts • 2,700K • CRI>80

E27 **MAX. 60W** **230V-240V**

- WL2198**
- 280mmH x 150mmW x 74mmD
 - Opal white glass

E27 **MAX. 100W** **230V-240V**

- WL2070**
- 250mmH X 250mmW X 80mmD

E27 **MAX. 75W** **230V-240V**

- WL2022**
- Acid Glass
 - 300mmH x 235mmW

Vanity & Bedside Lights



LED
G9-3WLED-WW



- 66 lm/W • 198 total lm
- 3Watts • 3,000K • CRI>80 • 360° Beam

G9 MAX. 25W

CR1861-1B

- Chrome with solid glass shade
- 200mmH x 100mmW
- Mounting base 130mmH x 75mmW
- Pull cord switch

G9 MAX. 20W IP 44

WL4337

- Chrome with opal glass
- 210mmH x 100mmW x 130mmD
- Mounting base 85mmØ

LED
CANP-3SEWW



- 100 lm/W • 300 total lm
- 3Watts • 3,000K • CRI>80 • 270° Beam

LED
CANP-4SEWW



- 70 lm/W • 280 total lm
- 4Watts • 3,000K • CRI>80 • 210° Beam

E14 MAX. 60W

WL3091-CH

- Chrome and glass
- 290mmH x 150mmD x 60mmW
- Base 250mmH x 60mmW

Classic Wall Lighting

PICTURE & MIRROR LIGHTS



P28-SC



P28-BB



P21-SC 210mm



P21-BB 210mm



P33-SC 330mm



P33-BB 330mm

HALOGEN

2x G9-25F



- 10 lm/W • 250 total lm • Dimmable
- 25Watts • 3,000K • CRI>100

LED

2X G9-3WLED-WW



- 66 lm/W • 198 total lm
- 3Watts • 3,000K • CRI>80 • 360° Beam

2x **MAX. 25W** **G9**

P28

- Satin Chrome or Brushed Brass
- 285mmL x 160mmD

MAX. 40W **230V-240V** **E14**



P21

- Satin Chrome or Brushed Brass
- 210mmL x 165mmD

2x **MAX. 40W** **230V-240V** **E14**



P33-SC

- Satin Chrome or Brushed Brass
- 330mmL x 165mmD

SWING ARM WALL BRACKETS



PD8163-CH



PD8163-BS

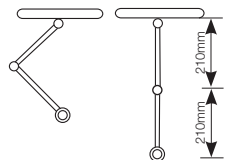

Adjustable model – swing both arms to any position

B22

PD8163

- Brass or Chrome
- 455mm fully extended
- Base 90mmW x 130mmH

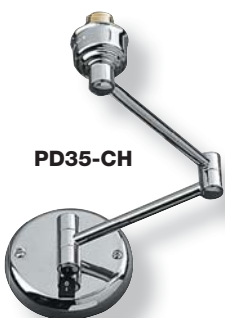

PD35-CH



PD35-WH



SWCAP Switch blank-off insert for models PD35

B22

PD35

- Chrome or White
- 350mm
- Base 120mmØ

Contemporary Wall Lights



WL3371

WL3361

WLR2161



WL2252-WH

FLUORESCENT SBFSP-7SEWW



- 50 lm/W • 350 total lm
- 7Watts • 2,700K • CRI>80

LED CANC-3SEWW



- 100 lm/W • 300 total lm
- 3Watts • 3,000K • CRI>80 • 270° Beam

E14 MAX. 60W 230V-240V

WL3371

- 265mmL x 120mmW x 170mmD

E14 MAX. 60W

WL3361

- 150mmL x 148mmW x 172mmD
- Pull cord switch

E14 MAX. 60W 230V-240V

WLR2161

- 150mmØ Glass
- 185mmD
- 60mmW x 100mmH Mounting Base
- Acid glass with Chrome edging

LED GLSD-6EWW



- 75 lm/W • 450 total lm • Dimmable
- 6Watts • 3,000K • CRI>81 • 270° Beam

FLUORESCENT SBFSP-14EWW



- 60 lm/W • 840 total lm
- 14Watts • 2,700K • CRI>80

Flexi Spot:

INTEGRAL



- 80 lm/W • 80 total lm
- 1Watts • 3,000K • CRI>81 • 18° Beam

Main Shade:

E27 MAX. 60W 230V-240V

WL2252-WH

- Fabric shade 220mmØ x 160mmH
- Mounting base 120mmH x 80mmW
- 260mm depth
- Flexible LED arm 320mm overall length including head
- LED flexi Spot 1925 lux at 0.5 metres 540 lux at 1 metre
- Shade and LED stem switched separately at base switches

Pendants & Wall Lights



LED
GLSC-6EWW



- 100 lm/W • 600 total lm
- 6Watts • 3,000K • CRI>81 • 270° Beam

LED
GLSD-9EWW



- 92 lm/W • 828 total lm • Dimmable
- 9Watts • 3,000K • CRI>81 • 270° Beam

DEVON



OVERALL LENGTH 1000mm

Q458 Glass Shade

R4581-1P-AB R4581-1P-BL R4581-1P-SC



R4581-1P

- Antique Brass, Black or Satin chrome
- 450mmH x 360mmØ

VICTORIANA SERIES



R3151-1B-AB R900-1P-AB CP2176-BZ



R3151-1B-AB

- Antique Brass
- 150mmØ
- Mounting plate 160mm x 110mm



R900-1P-AB

- Antique Brass
- 250mmØ x 800mm overall height



CP2176-BZ

- Bronze
- 480mmØ x 650mmH
- Use LED or Halogen lamp

CARLO



R6436-2C-AB



R6436-2C-AB

- Antique Brass
- 120mmH x 370mmØ
- Ceiling fitting

Pendants & Wall Lights

Classic Styling from Central Europe • Supplied complete with shades • Chain lengths 500mm

HERITAGE



R9355-5P-AB

5x **E27** **MAX. 60W** **DCM**

R9355-5P-AB

- Pendant
- Acid Glass
- Antique Brass
- 380mmH x 620mmØ



R9353-3P-AB

3x **E27** **MAX. 60W** **DCM**

R9353-3P-AB

- Antique Brass
- 400mmH x 620mmØ
- **Q935** Glass Shade



R9352-2B-AB

2x **E27** **MAX. 60W**

R9352-2B-AB

- Antique Brass
- 210mmH x 400mmW



R9351-1B-AB

E27 **MAX. 60W**

R9351-1B-AB

- Antique Brass
- 210mmH x 190mmW

LED GLSC-6EWW



- **100 lm/W** • 600 total lm
- 6Watts • 3,000K • CRI>81 • 270° Beam

LED SMR-5EWW



- **85 lm/W** • 425 total lm
- 5Watts • 3,000K • CRI>80 • 210° Beam

Pendants & Wall Lights

LED
GLSC-6BWW



- 100 lm/W • 600 total lm
- 6Watts • 3,000K • CRI>81 • 270° Beam

LOGAN



R1044-1P-SC



R1043-3P-SC



R1042-2C-SC



R1041-1B-SC

MAX.
100W **B22**

R1044-1P-SC

- Satin Chrome
- 200mmH x 300mmØ

MAX.
60W **DCM** 3x **B22**

R1043-3P-SC

- American Diner
- Satin Chrome
- 620mmØ x 390mmH

MAX.
60W 2x **B22**

R1042-2C-SC

- 110mmH x 300mmØ

MAX.
60W **B22**

R1041-1B-SC

- 210mmH x 265mmD x 200mmW
- 200mmØ shade
- Oval base mounting 160mmH x 110mmW

Fisherman Series Lights

ANTIQUE BRASS



R5331-1B-AB



R4301-1P-AB



R5787-1P-AB

LED
GLSC-6EWW



- 100 lm/W • 600 total lm
- 6Watts • 3,000K • CRI>81 • 270° Beam

LED
GLSD-6EWW



- 75 lm/W • 450 total lm • Dimmable
- 6Watts • 3,000K • CRI>81 • 270° Beam

MAX. 60W E27

R5331-1B-AB

- Antique Brass
- 180mmØ
- Mounting base 105mmØ

MAX. 100W E27

R4301-1P-AB

- Antique Brass
- 320mmØ x 300mmH
- Overall 1000mm length
- Ceiling rose 105mmØ

MAX. 60W E27

R5787-1P-AB

- Antique Brass
- 180mmØ x 250mmH
- Overall 1100mm length
- Ceiling rose 105mmØ

SATIN CHROME



R5331-1B-SC



R4301-1P-SC



R5787-1P-SC

MAX. 60W E27

R5331-1B-SC

- Satin Chrome
- 180mmØ
- Mounting base 105mmØ

MAX. 100W E27

R4301-1P-SC

- Satin Chrome
- 320mmØ x 300mmH
- Overall 1000mm length
- Ceiling rose 105mmØ

MAX. 60W E27

R5787-1P-SC

- Satin Chrome
- 180mmØ x 250mmH
- Overall 1100mm length
- Ceiling rose 105mmØ

Adra Metal Pendants



These Adra crafted pendants have a dimpled multifaceted pattern & are available in 3 colours Bronze, Copper or Nickel.

LED
GLSC-6BWW



- 100 lm/W • 600 total lm
- 6Watts • 3,000K • CRI>81 • 270° Beam

FLUORESCENT
SBFBA-11BWW



- 60 lm/W • 660 total lm
- 11Watts • 2,700K • CRI>80

NEW



MS350-CO

MS350-BZ

MS350-NI



- MS350**
- Ceiling Rose 105mmØ
 - Shade 350mmØ x 360mmH
 - Overall length 1650mmL



MS250-CO

MS250-BZ

MS250-NI



- MS250**
- Ceiling Rose 105mmØ
 - Shade 250mmØ x 300mmH
 - Overall length 1600mmL

NEW



MS320-BZ

MS320-CO

MS320-NI



- MS320**
- Ceiling Rose 105mmØ
 - Shade 320mmØ x 190mmH
 - Overall length 1480mmL

Classic Metal Pendants

Suitable for a wide range of applications providing superb downlight illumination
 • Sturdy Superlux metal shade pendants are available in a wide range of designs.



MAX. 60W E27 □

MS 29020-BA
 200mmØ x 1600mmL

MAX. 60W E27 □

MS 15102-BA
 133mmØ x 1400mmL

MAX. 60W E27 □

MS 27902-BA
 264mmØ x 1600mmL

LED
GLSC-6EWW



- 100 lm/W • 600 total lm
- 6Watts • 3,000K • CRI>81 • 270° Beam

LED
GLSD-6EWW



- 75 lm/W • 450 total lm • Dimmable
- 6Watts • 3,000K • CRI>81 • 270° Beam



MAX. 60W E27 □

MS 70358
 250mmØ x 1600mmH

E14

LED
CANP-4SEWW



- 70 lm/W • 280 total lm
- 4Watts • 3,000K • CRI>80 • 210° Beam

E14 MAX. 40W □

MS 70357
 150mmØ x 1600mmH

Classic Suspension Pendants

Suitable for a wide range of applications providing superb downlight illumination. Sturdy Superlux metal shades pendants are available in a wide range of designs.



LED GLSC-6EWW



- 100 lm/W • 600 total lm
- 6Watts • 3,000K • CRI>81 • 270° Beam

LED GLSD-6EWW



- 75 lm/W • 450 total lm • Dimmable
- 6Watts • 3,000K • CRI>81 • 270° Beam

FLUORESCENT SBFBA-11EWW



- 60 lm/W • 660 total lm
- 11Watts • 2,700K • CRI>80



MS1021-BA

- 1600mm overall length
- Shade 100mmØ x 320mmL



MS349-BA

- Ceiling rose 110mmØ
- Shade 500mmØ x 300mmH
- Cord length 1400mmL



MS336-BA

- Ceiling rose 110mmØ
- Shade 350mmØ x 250mmH
- Cord length 1400mmL



MS34302-BA

- 360mmØ x 1650mmL



MS312-SI

- Cyber Pendant
- Ceiling rose 110mmØ
- Shade 330mmØ x 420mmH
- Cord length 1400mmL

MS336-BA

MS349-BA

MS1021-BA

MS 34202-BA

MS312-SI

(Trim ring removed)

LED Modern Decorative



CP226-R6

MS2254-CH

CP1041-1P-CH

CP226-L

INTEGRAL LED

- 88 lm/W • 1584 total lm
- 18Watts • 3,000K • CRI>80

CP226-R6

- Made from Acrylic & Chrome
- 6x 3W LED
- Adjustable to 1500mmH
- 410mmØ
- Mounting base 230mmØ
- Driver Included

INTEGRAL LED

- 80 lm/W • 240 total lm
- 3Watts • 3,000K • CRI>80 • 20° Beam

CP1041-1P-CH

- Chrome 1 light pendant
- 100mmØ mounting base
- Adjustable height to 2 metres
- Shade 40mmØ x 670mmH

FOR SINGLE PENDANTS

DISTANCE	LUX
1.m	1212
1.5m	510
2m	196

INTEGRAL LED

- 80 lm/W • 240 total lm
- 3Watts • 3,000K • CRI>80 • 20° Beam

MS2254-CH

- Chrome
- Shade 100mmØ x 112mmH
- Adjustable up to 1500mmH
- Mounting base 100mmØ

DISTANCE LUX

DISTANCE	LUX
1.m	1600
1.5m	655
2.4m	250

INTEGRAL LED

- 88 lm/W • 1584 total lm
- 18Watts • 3,000K • CRI>80

CP226-L

- Made from Acrylic & Chrome
- 6x 3W LED
- Adjustable to 1500mmH
- 95mmW x 1000mmL
- Mounting base 350mmL x 60mmW
- Driver Included

Modern Design Acid Glass



QH 420-SC
Satin Chrome

QH 300-SC
Satin Chrome

QH 300-AB
Antique Brass



QH2123-3

QH2123-1

LED
GLSD-6EWW



- **75 lm/W** • 450 total lm • Dimmable
- 6Watts • 3,000K • CRI>81 • 270° Beam

FLUORESCENT
SBFBA-11EWW



- **60 lm/W** • 660 total lm
- 11Watts • 2,700K • CRI>80

E27 **MAX.**
75W

QH420

- 420mmØ
- Overall length 1450mm

E27 **MAX.**
75W

QH300

- 300mmØ
- Overall length 1450mm

HALOGEN
GU10-35-A



- **10 lm/W** • 350 total lm • Dimmable
- 35Watts • 3,000K • CRI>100 • 36° Beam

LED
GU10D-5LED-WW



- **68 lm/W** • 340 total lm • Dimmable
- 5Watts • 3,000K • CRI>80 • 30° Beam

MAX.
35W **GU 10**

QH2123-3

- Mounting 560mmL x 120mm
- 1100mmL

MAX.
35W **GU 10**

QH2123-1

- Mounting 115mmØ
- 1100mmL

Decorative Ceiling & Wall

NEW

TULIP



R1765-5C-CH

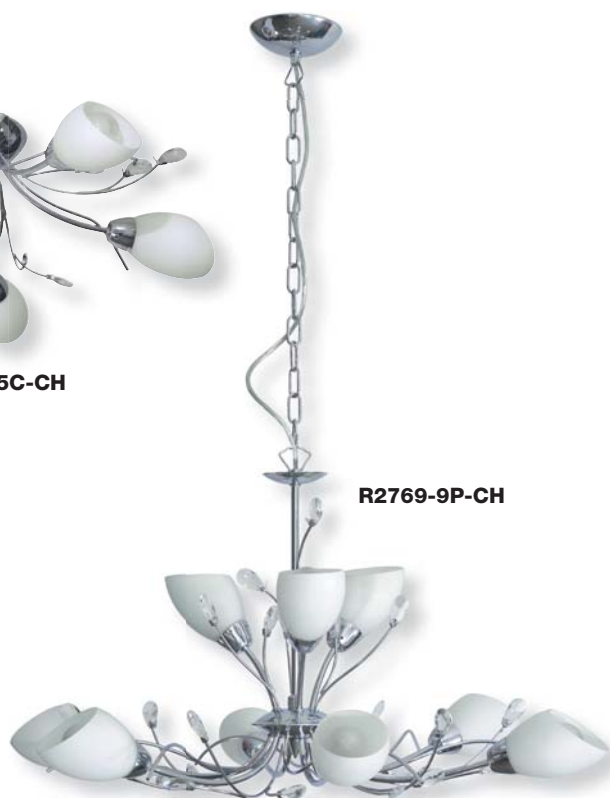

R2769-9P-CH

LED
CANP-4SEWW

- 70 lm/W • 280 total lm
- 4Watts • 3,000K • CRI>80 • 210° Beam

LED
CANC-3SEWW

- 100 lm/W • 300 total lm
- 3Watts • 3,000K • CRI>80 • 270° Beam

MAX.
40W

R1765-5C-CH

- 5 light
- 200mmH x 600mmØ
- Mounting base 125mmØ

MAX.
40W

R2769-9P-CH

- 9 light
- 400mmH x 760mmØ
- Mounting base 115mmØ
- Chain length 500mmL

Ceiling & Wall Lights

VELA



CP110-CH

LED
G9-3WLED-WW

- 66 lm/W • 198 total lm
- 3Watts • 3,000K • CRI>80 • 360° Beam

HALOGEN
G9-40F

- 10 lm/W • 400 total lm • Dimmable
- 40Watts • 3,000K • CRI>100

6x G9 MAX.
40W

CP110-CH

- 6 light pendant
- Chrome body with Acid glass shade
- 1105mmL
- Glass shade
65mmL x 40mmW x 90mmD
- Mounting base 72mm Square

Glass Pendants



LED GLSC-6EWW



- 100 lm/W • 600 total lm
- 6Watts • 3,000K • CRI>81 • 270° Beam

LED GLSD-6EWW



- 75 lm/W • 450 total lm • Dimmable
- 6Watts • 3,000K • CRI>81 • 270° Beam

E27 MAX.
40W

QH1011

- Dual shade construction Satin Chrome inside, clear glass outside.
- Shade 100mmØ x 310mmH
- Ceiling fitter 110mmØ
- 1600mm overall length

E27 MAX.
60W

QH9040

- Shade 100mmØ x 400mmH
- Ceiling fitter 100mmØ
- 1600mm overall length

E27 MAX.
60W

QH1172

- Shade 285mmØ x 220mmH
- Ceiling fitter 120mmØ
- 1600mm overall length

E27 MAX.
100W

QH5016

- Shade 190mmØ x 205mmH
- Ceiling fitter 145mmØ
- 1600mm overall length

LED CANC-3SEWW



- 100 lm/W • 300 total lm
- 3Watts • 3,000K • CRI>80 • 270° Beam

LED CANP-4SEWW



- 70 lm/W • 280 total lm
- 4Watts • 3,000K • CRI>80 • 210° Beam

E14 R50 MAX.
60W

QH2183

- Clear glass shade
- Shade 130mmØ x 500mmH
- Adjustable 1500mmH overall length
- Ceiling fitter 100mmØ
- Chrome

E14 MAX.
60W

QH2301

- Shade 100mmØ x 200mmH
- Adjustable length to 1600mmL
- Ceiling rose 130mmØ

Euro Glass Pendants

LARGE ACID GLASS

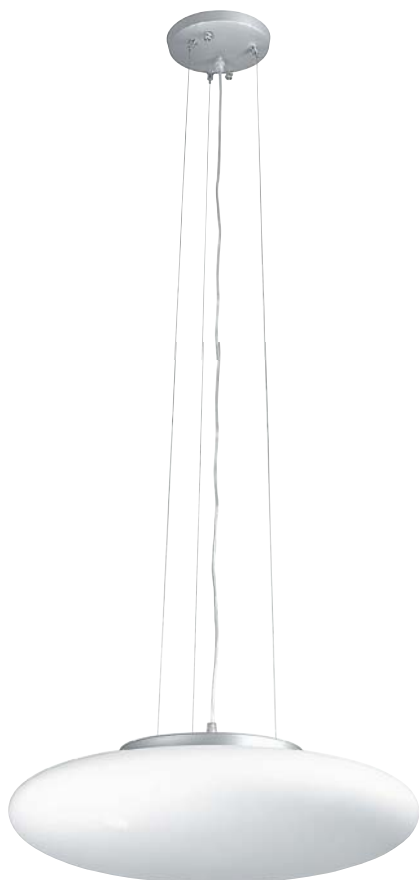

QH4803



QH2193-WH



QH2198-WH

LED
GLSC-6EWW

- 100 lm/W • 600 total lm
- 6Watts • 3,000K • CRI>81 • 270° Beam

LED
GLSD-6EWW

- 75 lm/W • 450 total lm • Dimmable
- 6Watts • 3,000K • CRI>81 • 270° Beam

FLUORESCENT
SBFSP-14EWW

- 60 lm/W • 840 total lm
- 14Watts • 2,700K • CRI>80

MAX. 60W 2X E27

QH4803

- Matt Silver fittings
- 480mmØ shade
- 1600mm overall length
- Closed shade construction

MAX. 60W E27

QH2193-WH

- Chrome and Acid glass
- Shade 280mmØ x 530mmH
- Adjustable to 1500mm overall length
- 100mmØ ceiling rose

MAX. 60W E27

QH2198-WH

- Chrome and Acid glass
- Shade 400mmØ x 190mmH
- Adjustable to 1500mm overall length
- 100mmØ ceiling rose

Ceiling Paper Shades

MAX.
60W

- Oriental inspired rice paper shades, wired ribbed. Model PS300 - bamboo ribbed.
- Models PS300, PS350 PS400, PS410 may be flush mounted directly onto ceiling batten holder or cord grip pendant lamp holder.



PS350
Ball
350mmØ

PS480
Ball
480mmØ



PS600
Ball
600mmØ

PS760
Ball
760mmØ

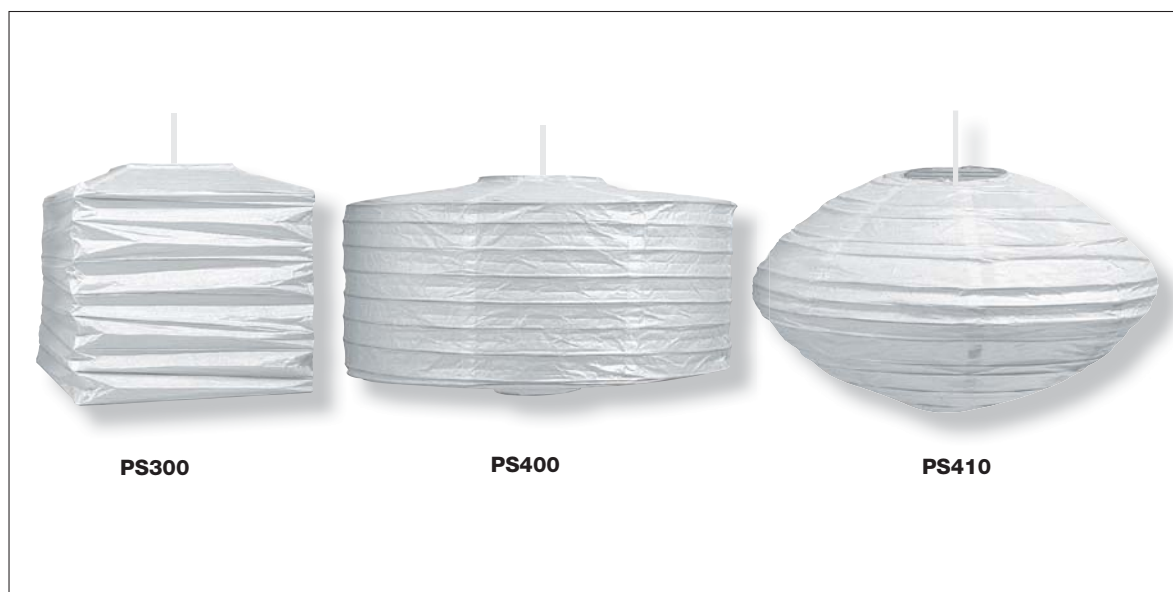

PS300
Box
300W x 300mmH

PS400
Drum
400mmØ

PS410
Cocoon
410mmØ

Euro Glass Pendants

ACID GLASS ROUND



QH200



QH290



QH400

LED
GLSC-6EWW

- **100 lm/W** • 600 total lm
- 6Watts • 3,000K • CRI>81 • 270° Beam

LED
GLSD-6EWW

- **75 lm/W** • 450 total lm • Dimmable
- 6Watts • 3,000K • CRI>81 • 270° Beam

FLUORESCENT
SBFSP-26EWW

- **60 lm/W** • 1560 total lm
- 26Watts • 2,700K • CRI>80

E27 MAX.
100W**QH200**

- Satin Chrome
- Ball 250mmØ
- 1700mm overall length
- Mounting 100mmØ

E27 MAX.
100W**QH290**

- Satin Chrome
- Ball 290mmØ
- 1790mm overall length
- Mounting 100mmØ

E27 MAX.
100W**QH400**

- Satin Chrome
- Ball 400mmØ
- 2400mm overall length
- Mounting 100mmØ

LED Polo Bulkheads

NEW

- Interchangeable covers fit onto the main body
- Covers supplied separately
- Wall or ceiling mount
- Covers available in 3 colours; Charcoal, Silver or White
- Polycarbonate body and lens - covers made from ABS
- Indoor & outdoor use
- Integral control gear wire directly to mains

SQUARE POLO BODY



LK2240 (Body)



Fully assembled body and cover

INTEGRAL



- 88 lm/W • 1200 total lm
- 13.5Watts • 3,000K • CRI>80



LK2240

- 13.5 Watt integral LED bulkhead body
- 220mm square x 55mm depth

PLAIN POLO COVERS



LK2241-CC



LK2241-SI

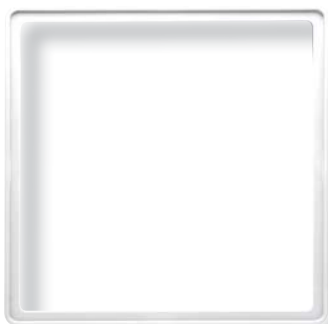

LK2241-WH

LK2241

- Cover only, place onto LK2240

LED Marco Bulkheads

NEW

- Interchangeable covers fit onto the body • 300mmØ x 90mm depth • Covers supplied separately
- Wall or ceiling mount • Covers available in 3 colours: Charcoal, Silver or White
- Integral control gear wire directly to mains • Polycarbonate body & lens, ABS covers

ROUND MARCO BODY



LK3050
(Without Sensor)



LKS3050
(With Sensor)



(Lens supplied with body)

SENSOR Model

INTEGRAL LED



- **88 lm/W** • 1200 total lm
- 13.5Watts • 3,000K • CRI>80



LK3050

- 13.5 Watt integral LED Bulkhead body
- Supplied in silver only

INTEGRAL LED



- **88 lm/W** • 1200 total lm
- 13.5Watts • 3,000K • CRI>80



LKS3050

- 13.5 Watt integral LED Bulkhead body with motion sensor
- Supplied in silver only

SENSOR:

- 360° detection angle
- Adjustable detection range from 1 to 8 metres
- Time setting adjustable 10sec to 12min
- Lux detection adjustable 10 to 2000 lux

Exploded view



COVER

LENS

BASE

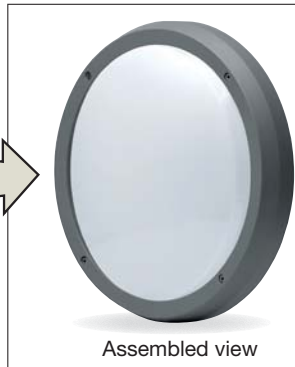

Assembled view

PLAIN MARCO COVER



LK3051-CC



LK3051-SI



LK3051-WH

LK3051 (cover only)

- Fits LK3050 or LKS3050 bodies

GUARD MARCO COVER



LK3052-CC



LK3052-SI



LK3052-WH

LK3052 (cover only)

- Fits LK3050 or LKS3050 bodies

6000 Series Polycarbonate Bulkheads



- New Zealand & Australian registered® designs • UV stabilised, & supplied with stainless steel screws
- Genuine Lexan Polycarbonate base and diffuser • IP55

E27



IP 55 Made in NZ
MAX. 60W **E27**

LJ 6001/2/3/4

E27

LED
GLSD-6EWW



- 75 lm/W • 450 total lm • Dimmable
- 6Watts • 3,000K • CRI>81 • 270° Beam

FLUORESCENT
SBFSP-14EWW



- 60 lm/W • 840 total lm
- 14Watts • 2,700K • CRI>80

FLUORESCENT

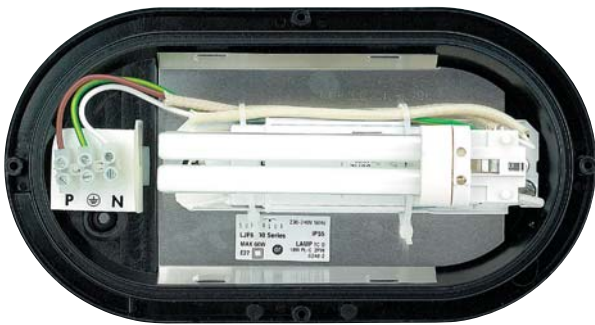

IP 55 Made in NZ
18W **G24 q-2**

- Fluorescent 18w magnetic ballasted

LJF 6001/2/3/4

G24q2

FLUORESCENT
PLCQ-18CW *Included*



- 68 lm/W • 1224 total lm
- 18Watts • 4,000K • CRI>82

LED



IP 55 Made in NZ



LJL 6001/2/3/4

INTEGRAL



- 66 lm/W • 665 total lm
- 10Watts • 3,000K • CRI>80

CONDUIT CONNECTOR



LJ6000-CON

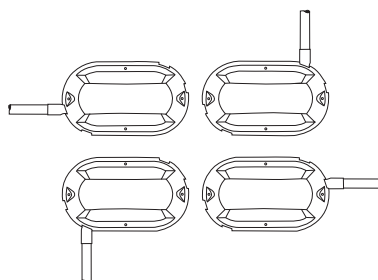

LJ6000-CON

Optional accessories Conduit Connection device for use with 20mmØ conduit
Can be used with all 6000 series bulkheads

Conduit converter kit for easy connectability of bulkheads

6000 Series Polycarbonate Bulkheads



WHITE



LJ6001-WH
LJF6001-WH
LJL6001-WH



LJ6002-WH
LJF6002-WH
LJL6002-WH



LJ6003-WH
LJF6003-WH
LJL6003-WH



LJ6004-WH
LJF6004-WH
LJL6004-WH

BLACK



LJ6001-BL
LJF6001-BL
LJL6001-BL



LJ6002-BL
LJF6002-BL
LJL6002-BL



LJ6003-BL
LJF6003-BL
LJL6003-BL



LJ6004-BL
LJF6004-BL
LJL6004-BL

SILVER GREY



LJ6001-SG
LJF6001-SG
LJL6001-SG



LJ6002-SG
LJF6002-SG
LJL6002-SG



LJ6003-SG
LJF6003-SG
LJL6003-SG



LJ6004-SG
LJF6004-SG
LJL6004-SG

GREEN



LJ6001-GN
LJF6001-GN
LJL6001-GN



LJ6002-GN
LJF6002-GN
LJL6002-GN



LJ6003-GN
LJF6003-GN
LJL6003-GN



LJ6004-GN
LJF6004-GN
LJL6004-GN

COPPER



LJ6001-CO
LJF6001-CO
LJL6001-CO



LJ6002-CO
LJF6002-CO
LJL6002-CO



LJ6003-CO
LJF6003-CO
LJL6003-CO



LJ6004-CO
LJF6004-CO
LJL6004-CO

SENSOR LIGHT



LJS6003-BL

NOW WITH
SENSOR



LJS6003-BL

- 6m x 100° range
- 100° Feild angle
- Photocell sensitivity adjustable
- On/off time adjustable
- Available in E27 black eyelid configuration only

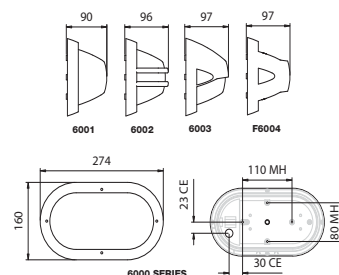

6000 Series Stainless Bulkheads



- New Zealand & Australian registered® designs
- UV stabilised, & supplied with stainless steel screws
- Polycarbonate diffuser

E27 OR PLC18



LJ6001-SS or LJF6001-SS or LJL6001-SS



LJ6002-SS or LJF6002-SS or LJL6002-SS

New Stainless models

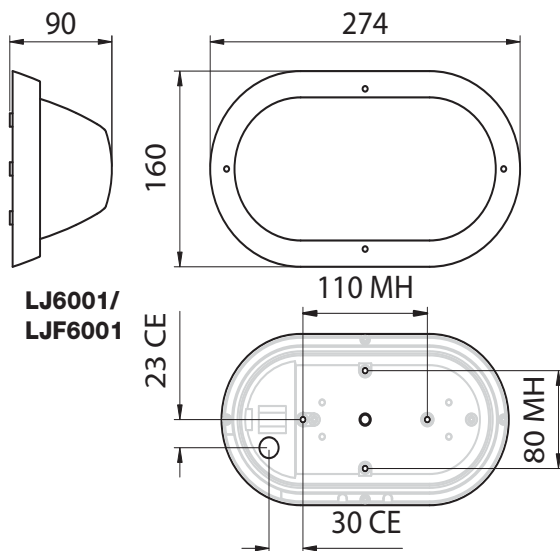

**LJ6001/
LJF6001**

E27

LED
GLSC-6EWW



- **100 lm/W** • 600 total lm
- 6Watts • 3,000K • CRI>81 • 270° Beam

FLUORESCENT
SBF3U-15EWW



- **60 lm/W** • 900 total lm
- 15Watts • 2,700K • CRI>80



LJ6001/2-SS

G24d2

FLUORESCENT
PLCD-18CW *Included*



- **68 lm/W** • 1224 total lm
- 18Watts • 4,000K • CRI>82



LJF6001/2-SS

Fluorescent bulkheads

- Fluorescent 18w magnetic ballasted

NEW

LJL6001/2

INTEGRAL



- **66 lm/W** • 665 total lm
- 10Watts • 3,000K • CRI>80

6000 Series Polycarbonate Bulkheads



- New Zealand & Australian copyright designs
- UV stabilised, & supplied with stainless steel screws • Polycarbonate diffuser

INCANDESCENT OR FLUORESCENT



LJ6051-WH
or
LJF6051-WH



LJ6051-BL
or
LJF6051-BL



LJ6051-SS
or
LJF6051-SS



LJ6051

- Available in White, Black or 316 Stainless Steel

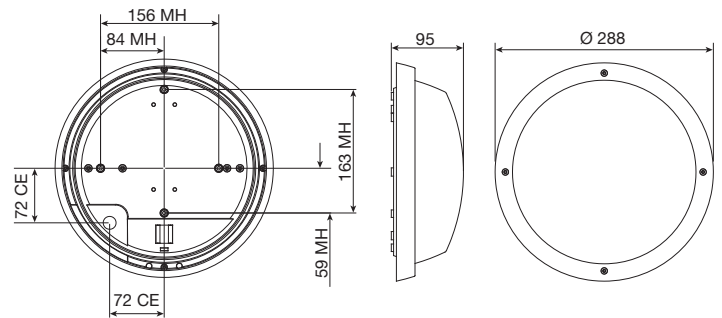

E27

LED GLSC-6EWW



- **100 lm/W** • 600 total lm
- 6Watts • 3,000K • CRI>81 • 270° Beam

FLUORESCENT SBFSP-14EWW



- **60 lm/W** • 840 total lm
- 14Watts • 2,700K • CRI>80



LJF6051 Fluorescent Bulkhead

- 26W magnetic ballasted
- Available in White, Black or 316 Stainless Steel

G24d2

FLUORESCENT PLCD-26CW *Included*



- **68 lm/W** • 1738 total lm
- 26Watts • 4,000K • CRI>82

CONDUIT CONNECTOR



LJ6000-CON

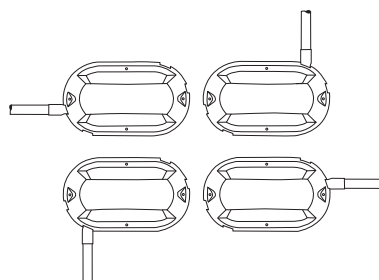

LJ6000-CON

Optional accessories Conduit Connection device for use with 20mmØ conduit
Can be used with all 6000 series bulkheads

Conduit converter kit for easy connectability of bulkheads

Italian Bulkheads

 Manufactured in Italy

• Strong, vandal resistant polycarbonate bulkheads.



LED
GLSC-6EWW

• 100 lm/W • 600 total lm
• 6Watts • 3,000K • CRI>81 • 270° Beam

FLUORESCENT
SBFSP-26EWW

• 60 lm/W • 1560 total lm
• 26Watts • 2,700K • CRI>80

IP 54 **MAX.** 75W
E27

LJ 4051
• No earth required

IP 54 **2x** 9W
PL 2 PIN

LJF 4051
• Fluorescent

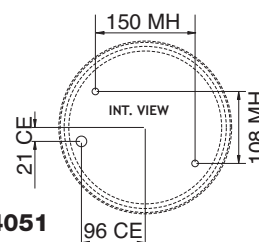
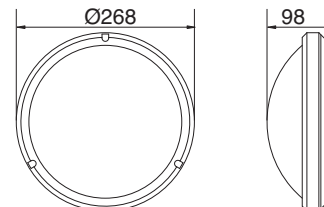

LJ/F 4051

EXAMPLES OF BULKHEADS / ACCESSORY COMBINATIONS



LJ4051 Bulkhead with FB3690 and FB3692 brackets, BZ-POL60-BL



Round bulkheads can be double mounted with FB 3690 and FB3693 brackets on BZ-POLE60



Bulkheads can be corner mounted with FB 3690 & FB 6962 bracket



LJ 4051 bulkhead wall mounted with FB 3690 bracket



FB 6962

FB 3693

FB 3692

FB 6960-BL

FB 3690

Stainless Bulkheads

HALOGEN G9-40F



- 10 lm/W • 400 total lm • Dimmable
- 40Watts • 3,000K • CRI>100

LED G9-3WLED-WW



- 66 lm/W • 198 total lm
- 3Watts • 3,000K • CRI>80 • 360° Beam



SB1450

SB1450

- Glass lens
- Halogen

MAX. 40W G9 304 Stainless Steel IP 54

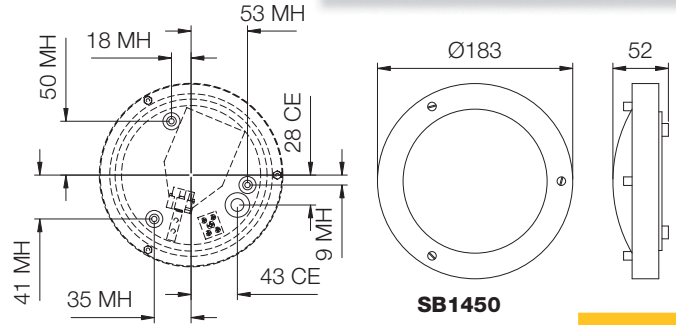

SB1450



SB1610

SB1610

- Glass lens

E27 MAX. 60W 304 Stainless Steel IP 54

LED GLSC-6EWW



- 100 lm/W • 600 total lm
- 6Watts • 3,000K • CRI>81 • 270° Beam

FLUORESCENT SBFSP-14EWW



- 60 lm/W • 840 total lm
- 14Watts • 2,700K • CRI>80

E27

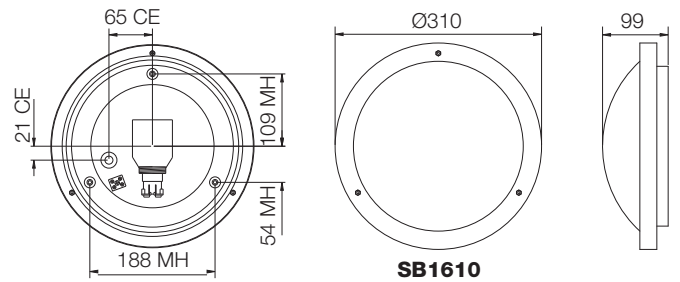

SB1610



SB1650

SB1650

- Glass lens

2x E27 MAX. 60W 304 Stainless Steel IP 54

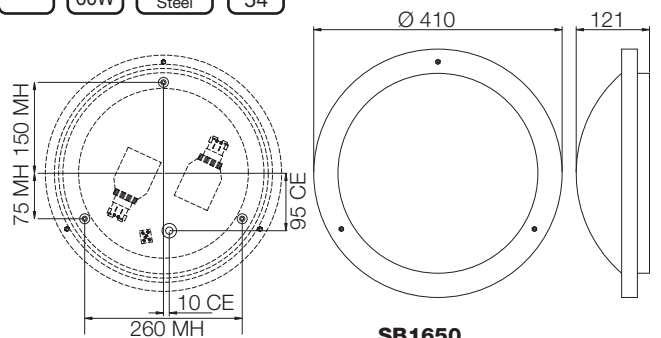

SB1650

"Refer to Material selection and Maintenance"

Duralite Range



Made in Italy

• Duracast Composite Resin • Lucca round style lantern • Rustic Brown finish

LUCCA RANGE



DUW377-BR



DUP377-BR



DUH377-BR

LED GLSC-6EWW



- **100 lm/W** • 600 total lm
- 6Watts • 3,000K • CRI>81 • 270° Beam

FLUORESCENT SBFBA-11EWW



- **60 lm/W** • 660 total lm
- 11Watts • 2,700K • CRI>80

FLUORESCENT SBFBA-24EWW



- **60 lm/W** • 1440 total lm
- 24Watts • 2,700K • CRI>80



DUW377-BR

- Wall mount lantern
- 280mmD x 500mmH x 210mmW
- Mounting base 212mmH x 122mmW



DUH377-BR

- Ceiling mount with hanging lantern
- Adjustable height chain from 850mm (full chain) to 660mm overall, using only one chainlink
- 210mmW x 460mmH
- Ceiling rose 115mmØ



DUP377-BR

- Post mount lantern head only purchase post separately
- 210mmW x 500mmH
- Fits 60mmØ pole **BZ-POLE60**

DURALITE
Hi-Tech Lighting Features



Duralite Range

- Duracast Composite Resin

CAMPANIA



DUW700-WH



DUW700-WH

- White
- Round Wall mount Lantern
- 280mmD x 500mmH x 210mmW
- Mounting base 125mmW x 210mmH

LED GLSD-6EWW



- **75 lm/W** • 450 total lm • Dimmable
- 6Watts • 3,000K • CRI>81 • 270° Beam

LED GLSC-6EWW



- **100 lm/W** • 600 total lm
- 6Watts • 3,000K • CRI>81 • 270° Beam

FLUORESCENT SBFBA-11EWW



- **60 lm/W** • 660 total lm
- 11Watts • 2,700K • CRI>80

CASTRA

NEW



DUW8100-WH



DUW8100-WH

- White
- Hexagon wall mount lantern, 2 different assembly options as shown
- 275mmD x 430mmH x 207mmW
- Mounting base 125mmW x 210mmH



Duralite Range



• Duracast Composite Resin



SANDWELL

DUW7010-BL

DUP7010-BL

LED
GLSC-6EWW

- 100 lm/W • 600 total lm
- 6Watts • 3,000K • CRI>81 • 270° Beam

FLUORESCENT
SBFBA-11EWW

- 60 lm/W • 660 total lm
- 11Watts • 2,700K • CRI>80



DUW7010-BL

- Black
- Four sided Wall lantern
- 230mmD x 320mmH x 175mmW
- Mounting base 145mmH x 113mmW



DUP7010-BL

- Black
- Four sided Post mount lantern head only purchase post separately
- 320mmH x 175mmW
- Fits 60mmØ pole **BZ-POLE60**



CROYDON

DUW7030-BL

DUP7030-BL



DUW7030-BL

- Black
- Hexagon Wall lantern
- 230mmD x 360mmH x 180mmW
- Mounting base 145mmH x 113mmW



DUP7030-BL

- Black
- Hexagon Post mount lantern head only, purchase post separately
- 330mmH x 180mmW
- Fits 60mmØ pole **BZ-POLE60**



FB69611

Polycarbonate Deck Mounting Stand for **DUP7030**



Duralite Range

- Duracast Composite Resin

VITTOTRIA & TURIN



DUW8302-BL

DUT8302-BL



Made in Italy

DUW8302-BL

- Black
- Hexagon Wall Lantern
- 310mmD x 470mmH x 245mmW
- Mounting base 310mmH x 120mmW



Made in Italy

DUT8302-BL

- Black
- Hexagon Pedestal wall top mount Lantern
- 245mmW x 530mmH
- Hexagon mounting base 190mm point to point 165mm flat to flat

LED GLSD-6EWW



- **75 lm/W** • 450 total lm • Dimmable
- 6Watts • 3,000K • CRI>81 • 270° Beam

LED GLSC-6EWW



- **100 lm/W** • 600 total lm
- 6Watts • 3,000K • CRI>81 • 270° Beam

FLUORESCENT SBFBA-11EWW



- **60 lm/W** • 660 total lm
- 11Watts • 2,700K • CRI>80

AVELLINO



DUW577-BL



Made in Italy

DUW577-BL

- Black
- 330mmD x 520mmH x 175mmW
- Mounting base 195mmH x 113mmW

DURALITE
Hi-Tech Lighting Features



Lexacast Louvre Lights



- Pole or wall mounted • Available in black or white. • Single or double fittings
- Strong, weatherproof polycarbonate - won't rust, fade, chip or flake.

F7301 LANTERN



F7301-WH



B062-WH



F7301-BL



B062-BL

F5301 BOLLARD



F5301-WH



F5301-BL

LED
GLSC-6EWW



- **100 lm/W** • 600 total lm
- 6Watts • 3,000K • CRI>81 • 270° Beam

FLUORESCENT
SBF3U-15EWW



- **60 lm/W** • 1080 total lm
- 15Watts • 2,700K • CRI>80

IP 53 **MAX.** 60W **E27**

F7301

- Comes in Black and White
- Head dimensions 255mmH x 255mmW
- Mounting base 130mmØ
- Wall Mounted
- Aust.des.app.no.835-1999

IP 53 **MAX.** 60W **E27** 76mmØ Pole Not Included

B062

- Images show 2 x **F7301** using **B062** adapter on Aluminium pole
- Comes in Black and White
- Mount onto 76mmØ pole **BZ-POLE** 1 or 2



IP 53 **MAX.** 60W **E27** 76mmØ Pole Not Included

F5301

- Mount onto 76mmØ pole **BZ-POLE** 1 or 2
- Comes in Black and White
- 260mmH 255mmØ
- Aust.des.app.no.836-1999

Outdoor Lanterns

CEILING MOUNT



F1060-SI

MAX.
60W **IP**
44

F1060

- Mounts onto **B22** batten holder
- 205mmW x 290mmH
- Available in Silver
- Non - Metallic, suits seaside use
- No discolouring
- No rusting
- No paint flaking
- UV resistant acrylic lenses

LED
GLSC-6BWW



- **100 lm/W** • 600 total lm
- 6Watts • 3,000K • CRI>81 • 270° Beam

FLUORESCENT
SBFBA-11BWW



- **60 lm/W** • 660 total lm
- 11Watts • 2,700K • CRI>80

CLASSIC OUTDOOR LANTERNS



DURALITE
Hi-Tech Lighting Features

DU10730-BL

IP
44 **MAX.**
100W **E27**  Made in Italy

DU10730-BL

- Black
- Modica Globe and post
- 300mmØ globe
- 2250mmH
- Base 240mm wide
- Made from durable duracast composite resin material
- Inside re-inforced with galvanised post

E27

LED
GLSC-6EWW



- **100 lm/W** • 600 total lm
- 6Watts • 3,000K • CRI>81 • 270° Beam

FLUORESCENT
SBFSP-26EWW



- **60 lm/W** • 1560 total lm
- 26Watts • 2,700K • CRI>80

"Refer to Material selection and Maintenance"
Warranty not valid for corrosive environments

Energy Saver Deflector Lanterns

POLE MOUNTED



F5894L-BL
+
BZ-Pole60-BL

 Manufactured
in Italy

MAX.
18W

IP
55

E27

Pole Not
Included



F5894L

- Shown mounted on 60mmØ pole
- Durable Polycarbonate
- 300mmØ x 180mmH
- Mounts onto 60mmØ pole or bracket

LED GLSC-6EWW



- **100 lm/W** • 600 total lm
- 6Watts • 3,000K • CRI>81 • 270° Beam

FLUORESCENT SBFSP-14EWW



- **60 lm/W** • 840 total lm
- 14Watts • 2,700K • CRI>80

WALL MOUNTING BRACKETS



F5894L-BL
+
FB6932-BL
Short Bracket



F5894L-BL
+
FB6931
Long Bracket

 Manufactured
in Italy

MAX.
18W

IP
55

E27

FB6932

- Durable Polycarbonate
- Lantern sold separately to bracket
- 158mmL
- 100mm x 100mm mounting

FB6931

- Available in Black only
- Durable Polycarbonate
- Lantern sold separately to bracket
- 215mmL
- 100mm x 100mm mounting

76mmØ RESIN POLES



BZ- Pole2-BL (2 metre)



BZ-Pole1-BL (1 metre)



BZ-FLANGE

BZ FLANGE Deck mount

- For 76mmØ post.
- Base 160mmØ
- Internal 76mmØ



2mm wall thickness

Fill with concrete or otherwise brace to aid vertical stability.

60mm POLES & ACCESSORIES



BZ-Pole60-BL

RESIN POLES
1.8 metre lengths



FB6960-BL

FB 6960 Deck mount

- For 60mmØ post.
- Base 165mmØ
- Internal 60mmØ



Outdoor Lighting

G10q

FLUORESCENT
GIR-22-TP
Included



• **55 lm/W** • 1210 total lm
• 22Watts • 5,000K • CRI>75

MUSHROOM LIGHT



BZF-104L-BL



Manufactured in
New Zealand



New Zealand's most popular and durable landscape fitting.

- Shatterproof diffuser.
- 425mmØ x 225mmH
- Mount onto either
BZ POLE-1, BZ POLE-2



BZF-104L Fluorescent

BALTIMORE BOLLARD

DURALITE
Hi-Tech Lighting Features



DUF80-BL



Made in
Italy



DUF80-BL

- Black
- Round Duralite bollard
- Made from Hi-tech composite resin
- Vandal resistant
- 170mmØ x 780mmH

E27

LED
GLSC-6EWW



• **100 lm/W** • 600 total lm
• 6Watts • 3,000K • CRI>81 • 270° Beam

FLUORESCENT
SBFSP-14EWW



• **60 lm/W** • 840 total lm
• 14Watts • 2,700K • CRI>80

C4025 BOLLARD



C4025L-BL



C4025L

- Aluminium with glass diffuser.
- Mount onto either
BZ POLE-1, BZ POLE-2
- 150mmW x 200mmH

"Refer to Material selection and Maintenance"

ALL SPECIFICATIONS SUBJECT TO CHANGE WITHOUT NOTICE

Stainless & Resin Outdoor Lighting

BRUSHED STAINLESS STEEL, POLYCARBONATE LENS



FS4996



FS4997



GV-S06-GE

FLUORESCENT SBF3U-15EWW



- 60 lm/W • 900 total lm
- 15Watts • 2,700K • CRI>80

E27 MAX. 15W IP 44 304 Stainless Steel

FS4996

- 650mmH x 60mmØ
- Mounting flange 100mmØ
- Use only with Self Ballasted Fluorescent

GU10

HALOGEN GU10-35-A



- 10 lm/W • 350 total lm • Dimmable
- 35Watts • 3,000K • CRI>100 • 36° Beam

LED GU10-HPLED-WH



- 60 lm/W • 300 total lm
- 5Watts • 4,000K • CRI>80 • 30° Beam

E27 MAX. 15W GU 10 MAX. 35W IP 44 304 Stainless Steel

FS4997

- 340mmH x 62mmØ
- Top light only for Self Ballasted Fluorescent use
- Down light uses GU10 bulb
- Base 104mmH x 43mmW

MR16

HALOGEN MR16-20-D38



- Included**
- 10 lm/W • 200 total lm • Dimmable
 - 20Watts • 3,000K • CRI>100 • 38° Beam

LED MR16-HPLED-WH



- 80 lm/W • 480 total lm
- 6Watts • 3,000K • CRI>80 • 38° Beam

MAX. 35W MR16 12V

GV-S06-GE

- Stone finish
- 450mmH x 120mm square
- Made from durable resin material
- SVE-T60 transformer can fit into bollard column

"Refer to Material selection and Maintenance"
Warranty not valid for corrosive environments

Outdoor Lighting Mounting Accessories

WEATHER BOARD PACKER



WBP110 & WBF110
• 110mmW x 105mmH 3 degrees

WBP145 & WBF145
• 145mm x 145mm 3 degrees

Weather board packers to mount Up/Down tube lights, Lanterns and bulkheads on a vertical surface, simply click and arrange together multiple packers to build a satisfactory vertical mounting surface.

- Packers have a knock out hole for wiring
- Easy to trim
- Coloured to match double hasst paint or paint to match your weather boards

EXAMPLES



Vertical mounting



Bulkheads

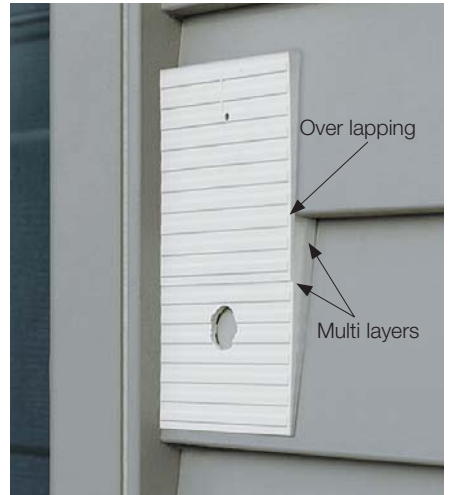

Vertical over lapping



Can be nailed or screwed in place



Installation



Horizontal mount

Duralite Range



• Duracast Composite Resin



DUW4000-BZ

DUW4000-SI



DU4510-BZ

DU4510-SI



DUT6002-BZ

DU6002-BZ

LED
GLSC-6EWW

- 100 lm/W • 600 total lm
- 6Watts • 3,000K • CRI>81 • 270° Beam

FLUORESCENT
SBFBA-11EWW

- 60 lm/W • 660 total lm
- 11Watts • 2,700K • CRI>80



DUW4000

- Available in Bronze or Silver
- 230mmD x 220mmW x 225mmH
- Mounting base 88mmØ



DU4510

- Available in Bronze or Silver
- 155mmW x 520mmH
- Mounting base 120mmØ
- Includes pole with inground mounting kit or can be mounted directly onto concrete or decking

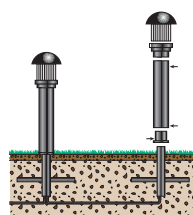

Fixing into the ground

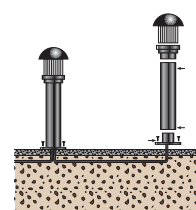

Fixing onto concrete (or masonry elements)



DUT6002-BZ

- Wall top lantern
- Bronze
- 160mmW x 270mmH
- Mounting base 100mmØ



DU6002-BZ

- Bronze
- 160mmW x 580mmH
- Mounting base 120mmØ
- Includes pole with inground mounting kit or can be mounted directly onto to concrete or decking
- If post supplied is insufficient height, **BZ-Pole1** / **BZ-Pole2** may be used



Duralite Range



- Duracast Composite Resin

TUSON SPOTLIGHT

DUW2000-BZ **DUW2000-SI**

TUSON POST SPOTLIGHT

DU5710-BZ **DU5710-SI**

FLUORESCENT
SBF80-13EWW

- **60 lm/W** • 780 total lm
- 13Watts • 2,700K • CRI>80 • 70° Beam

LED
R80-10EWW

- **70 lm/W** • 700 total lm
- 10Watts • 3,000K • CRI>81 • 120° Beam



- DUW2000**
- Available in Bronze or Silver
 - 230mmD x 240mmW
 - Mounting base 85mmØ
 - Spot head = 100mmØ



- DU5710**
- Available in Bronze or Silver
 - 770mmH
 - Mounting base 120mmØ
 - Spot head = 100mmØ
 - Includes pole with inground mounting kit or can be mounted directly onto concrete or decking
 - If post supplied is insufficient height, **BZ-Pole1** / **BZ-Pole2** may be used

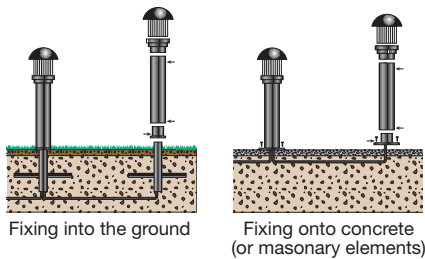

LED Security Flood Lights

- Die cast Aluminium • Mounting bracket for eave or wall mounting

10 WATT



INTEGRAL

LED

- **75 lm/W** • 750 total lm
- 10Watts • 4,000K • CRI>80 • 120° Beam

IP
65

KR10

- Available in Black, White or Silver
- 10 Watt LED flood light with similar light effect to 100W
- 115mmW x 85mmD x 85mmH
- Quality integral long lasting Meanwell driver and high brightness, low light depreciation Bridgelux LED COB



10 WATT WITH PIR SENSOR



INTEGRAL

LED

- **75 lm/W** • 750 total lm
- 10Watts • 4,000K • CRI>80 • 120° Beam

IP
65

KSR10

- Available in Black, White or Silver
- 10 Watt LED flood light with similar light effect to 100W
- PIR motion sensor detection range is 180° and 12 metres depth
- 140mmW x 100mmD x 180mmH
- Quality integral long lasting Meanwell driver and high brightness, low light depreciation Bridgelux LED COB

LED Security Flood Lights

- Die cast Aluminium • Mounting bracket for eave or wall mounting

20 WATT



KG20-BL



KSG20-BL

INTEGRAL



- 70 lm/W • 1400 total lm
- 20Watts • 4,000K • CRI>80 • 120° Beam



KG20-BL

- Available in Black only
- 20 Watt LED flood light with similar light effect to 200W
- 200mmW x 130mmD x 170mmH

INTEGRAL



- 70 lm/W • 1400 total lm
- 20Watts • 4,000K • CRI>80 • 120° Beam



KSG20-BL

- Available in Black only
- 20 Watt LED flood light with similar light effect to 200W
- PIR motion sensor detection range is 180° and 12 metres depth
- 200mmW x 130mmD x 250mmH

30 WATT



KR30-SI



KSR30-SI

INTEGRAL



- 75 lm/W • 2250 total lm
- 30Watts • 4,000K • CRI>80 • 120° Beam



KR30-SI

- Available in Silver only
- 30 Watt LED flood light with similar light effect to 300W
- 225mmW x 120mmD x 190mmH
- Quality integral long lasting Meanwell driver and high brightness, low light depreciation Bridgelux LED COB

INTEGRAL



- 75 lm/W • 2250 total lm
- 30Watts • 4,000K • CRI>80 • 120° Beam



KSR30-SI

- Available in Silver only
- 30 Watt LED flood light with similar light effect to 300W
- PIR motion sensor detection range is 180° and 12 metres depth
- 225mmW x 120mmD x 240mmH
- Quality integral long lasting Meanwell driver and high brightness, low light depreciation Bridgelux LED COB

LED Security Flood Lights

- Die cast Aluminium • Mounting bracket for eave or wall mounting

50 WATT



KR50-SI

INTEGRAL



- **75 lm/W** • 3750 total lm
- 50Watts • 4,000K • CRI>80 • 120° Beam

IP
65

KR50-SI

- Available in Silver only
- 50 Watt LED flood light with similar light effect to 500W
- 290mmW x 125mmD x 240mmH
- Quality integral long lasting Meanwell driver and high brightness, low light depreciation Bridgelux LED COB

100 WATT



KR100-SI

INTEGRAL



- **75 lm/W** • 7500 total lm
- 100Watts • 4,000K • CRI>80 • 120° Beam

IP
65

KR100-SI

- Available in Silver only
- 100 Watt LED flood light with similar light effect to 1000W
- 290mmW x 105mmD x 360mmH
- Quality integral long lasting Meanwell driver and high brightness, low light depreciation Bridgelux LED COB

PAR38 Flood Lights

TWIN SENSOR FLOODLIGHTS



KS300-BL



KS300-WH

LED
PAR38-12WLED-WH

• **80 lm/W** • 960 total lm
• 12Watts • 3,000K • CRI>80 • 63° Beam



LED
PAR38-LED-WH

• **60 lm/W** • 240 total lm
• 4Watts • 3,000K • CRI>75 • 22° Beam



2x **MAX. 150W** **IP 33** **E27**

KS300

- Sensor light uses passive infrared motion detection
- PAR38
- Wall or eave mounted
- Discreet design, powerful performance
- Mounting base 105mmØ

PAR38 DURABLE FLOODLIGHTS



KP150-BL



KP300-BL

MAX. 150W **E27**

KP150-BL

- PAR 38
- Strong construction
- Wall or eave mount
- Ceramic lamp holder
- Mounting base 88mmØ

2x **MAX. 150W** **E27**

KP300-BL

DUSK TO DAWN NIGHT LIGHTS



KPDS150-BL



KPDS300-BL

MAX. 150W **E27**

KPDS150-BL

- PAR 38
- Dusk to dawn photocell switch, ensures light is on at night for security yet turns off in the day, to ensure energy saving
- Strong construction
- Wall or eave mount
- Mounting base 88mmØ

2x **MAX. 150W** **E27**

KPDS300-BL

E27

Sign Lighting Flood Lights

TRADITIONAL SIGN LIGHT



WS240-CH
Chrome



WS240-BL
Black

E27 **IP**
23 **MAX.**
100W

WS240

- Arm length 500mm
- 240mmØ shade
- For commercial sign lighting.
- Traditional style sign light.
- Simple, Decorative, Aesthetic
- Rugged Steel construction

LED GLSC-6EWW



- **100 lm/W** • 600 total lm
- 6Watts • 3,000K • CRI>81 • 270° Beam

LED GLSD-6EWW



- **75 lm/W** • 450 total lm • Dimmable
- 6Watts • 3,000K • CRI>81 • 270° Beam

FLUORESCENT SBFBA-20EWW



- **60 lm/W** • 1200 total lm
- 20Watts • 2,700K • CRI>80

ENERGY SAVER FLOODLIGHT



KDU15-BL

E27 **IP**
44 **MAX.**
15W

KDU15-BL

- Flood head 200mmW x 80mmD x 80mmH
- Mounting base 90mmØ
- Fully extended arm with head 200mm
- Head tilts 180°

E27

FLUORESCENT SBF3U-15EWW



- **60 lm/W** • 900 total lm
- 15Watts • 2,700K • CRI>80

LED SMR-5EWW



- **85 lm/W** • 425 total lm
- 5Watts • 3,000K • CRI>80 • 210° Beam

LED Directional Floodlights

35WATT



SSL35-WH



SSL35-BL

INTEGRAL



- 80 lm/W • 2805 total lm
- 35Watts • 4,200K • CRI>85 • 30° Beam

IP
40

SSL35

- 35Watt integral LED
- Integral driver
- 260mmW x 398mmH x 286mmL

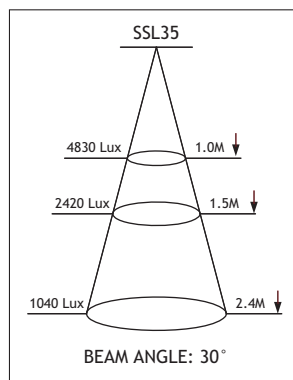



Metal Halide Uplight/Floodlights

90 lm/W



WL308-WH
WL309-WH



WL308-SG
WL309-SG

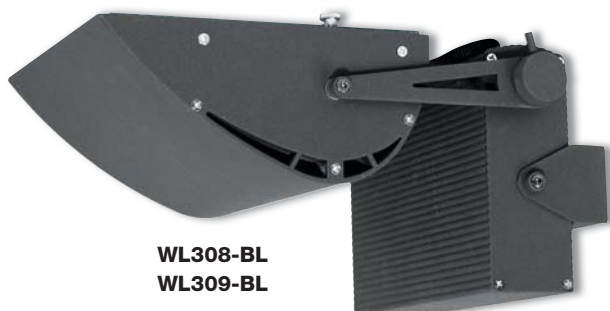

WL308-BL
WL309-BL

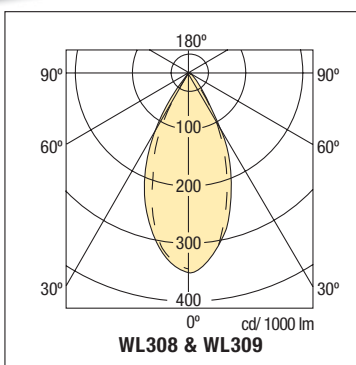
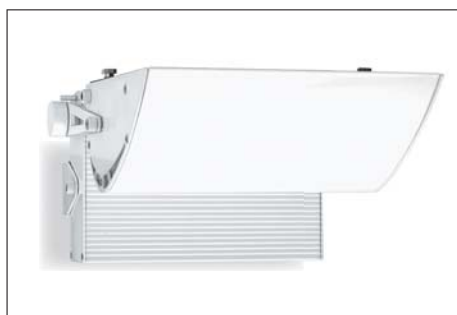

RX7s 118mm

METAL HALIDE MHLIN-70



- 90 lm/W • 6300 total lm • Dimmable
- 70Watts • 4,000K • CRI>80

70W

RX7s
118

WL308

- Available in Gloss White, Satin Black and Sandy Silver Grey
- Adjustable angle
- Electronic HEP control gear included in base
- For Interior use only
- 220mmW x 270mmD x 130mmH
- Mounting bracket 40mmH x 190mmL

RX7s 135mm

METAL HALIDE MHLIN-150



- 90 lm/W • 13500 total lm • Dimmable
- 150Watts • 4,000K • CRI>80

150W

RX7s
135

WL309

- Available in Gloss White, Satin Black and Sandy Silver Grey
- Adjustable angle
- Electronic control gear included in base
- For Interior use only
- 220mmW x 270mmD x 130mmH
- Mounting bracket 40mmH x 190mmL

PIR SENSOR



ND180-BL



ND180-WH

ND180

- 12 metre 180° exterior wall PIR motion detector
- Recommended mounting height 2.2m
- Adjustable sensor from left to right 120°, up and down 30°
- Adjustable time and lux settings
- Relay switched suitable for energy saver lamp technology
- 95mmH x 95mm Depth x 64mmW
- Max 1000 watt Incandescent
- Max 400 watt Fluorescent

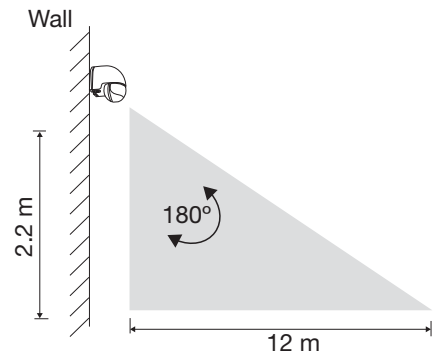

PHOTOCELL SENSOR



ND100-BL



ND100-WH



ND100

- Photocell dusk to dawn sensor
- Automatic security and safety
- Will automatically turn lights on at night time and will switch lights off during the day
- Adjustable sensitivity between 1-10 Lux
- 10A relay
- 95mmH x 95mm Depth x 64mmW

WET AREA PIR



ND365

IP
54

ND365

- 9 metre 360° ceiling PIR motion detector
- Recessed Mount
- 70mmØ hole cut, 45mm cavity depth
- 79mmØ x 20mm depth below ceiling
- Adjustable time delay and lux settings
- Detecting angle is adjustable from 30° to 360° using 30° segment supplied cap
- Digital technology PIR
- Can be mounted outdoor under eaves etc
- Max 1000 watt Incandescent
- Max 400 watt Fluorescent

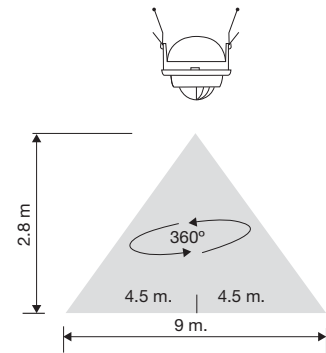

INTERIOR PIR



ND360

IP
20

ND360

- 9 metre 360° ceiling PIR motion detector
- Surface Mount
- Recommended mounting 2.8mH
- 140Ø x 40mm Depth
- Adjustable time delay and lux settings
- Max 1000 watt Incandescent
- Max 400 watt Fluorescent

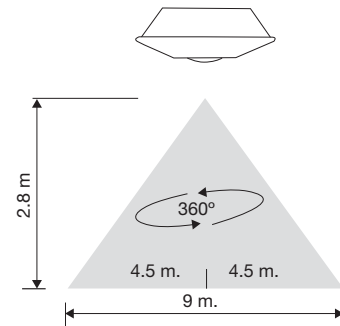

Electrical Enclosures

NEW

- Made from fire safe grade V-O ABS plastic
- Inside mounting rails accept 6 gauge screws

SNAP ON LID



EER65



EES80

IP
44

EER65

- 4x cable entry points
- 65mm \varnothing x 35mmH

IP
44

EES80

- 6x cable entry points
- 80mm Square x 40mmH

SCREW FIXED LID



EES100



EEO150



EEO240

IP
55

EES100

- 6x cable entry points
- 100mm Square x 50mmH

IP
55

EEO150

- 10x cable entry points
- 150mmL x 110mmW x 70mmH

IP
55

EEO240

- 12x cable entry points
- 240mmL x 190mmW x 90mmH

METAL FLUSH BOXES

NZ's largest selling metal electrical flush boxes



FLUSH-O

- Open back flush box
- Pre-nailed
- Very quick and accurate installation
- Optional screw fixing
- For both vertical and horizontal installation
- Economical



FLUSH-S

- Enclosed single flush box
- Traditional strong design
- 26mm diameter entry hole and 4 knockout holes
- Made from galvanised steel
- 50mm x 50mm x 74mm

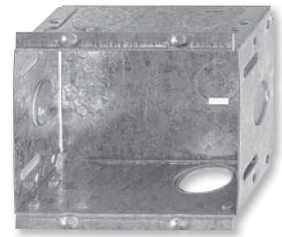

FLUSH-D

- Enclosed double flush box
- 21mm diameter entry hole and 5 knockouts
- Made from galvanised steel
- 50mm x 95mm x 74mm



FB-60

- Fire test FP3425 with Superlux Flush-S and Flush-D
- Fire and acoustic blocks
- Fire rating FRR—/60/60 to AS1530 Pt4 and AS4072 Pt1
- Acoustic to STC58
- 1 block in Flush-S achieves 120 minutes
- 2 blocks in Flush-D achieves 90 minutes



SD-MASTIC

For use with fire rated downlights

Transformers

SVE-T60

Miniature
10-60watts
118mm x 33mm x 21mm



Ballasts for circular fluorescent
BAL-T922 - 22watt
78mmL x 43mmW x 30mmH



BAL-T932 - 32watt
BAL-T940 - 40watt
142mmL x 47mmW x 35mmH

SVE-T200

70-200watts
215mmL x 47mmW
x 45mmH

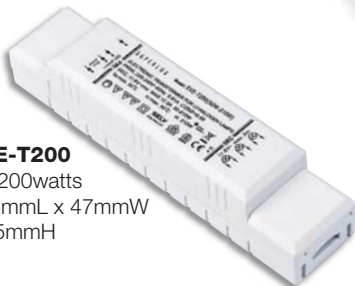

SVE-T70 (20-70watts)
57mmØ x 25mmH

ELECTRONIC TRANSFORMER

- For built in use only, ensure cord restraints are used
- Thermal Safety Fuse with short circuit overload protection
- Output cable max length 1x 6M or 2 x 4M



Weatherproof Transformer GV-T60

60watts
5amps
65mm x 75mm x 87mm



SVE-T50

20-50watts
100 nanofarads
119mmL x 52mmW x 35mmH





SBFSP-7SEWW

SBFSP-7SEWW

- SPIRAL, Warm White 2700K
- Overall length 90mm
30mmØ



SBFSP-7EWW

SBFSP-7EWW

- SPIRAL, Warm White 2700K
- Overall length 90mm
30mmØ



SBFSP-14EWW

SBFSP-14EWW

- SPIRAL, Warm White 2700K
- Overall length 106mm
48mmØ



SBFSP-14BWW

SBFSP-14BWW

- SPIRAL, Warm White 2700K
- Overall length 106mm
48mmØ



SBFSP-26EWW

SBFSP-26EWW

- SPIRAL, Warm White 2700K
- Overall length 141mm
61mmØ



SBF3U-15EWW

SBF3U-15EWW

- 3U, Warm White 2700K
- Overall length 137mm
40mmØ



SBF4U-65EDL

SBF4U-65EDL

- 4U, Daylight 6500K
- Overall length 225mm
66mmØ



Self Ballasted Fluorescent Lamps

60 lm/W



SBFBA-5SEWW



SBFBA-5BWW



SBFBA-11EWW



SBFBA-11BWW



SBFBA-20EWW



SBFBA-20BWW



SBF300-8PWW
TUBE300-LEDWW



SBF500-13PWW
TUBE500-LEDWW



SBF80-13EWW



SBF30-15ECW



SBFBA-5SEWW

- Ball, Warm White 2700K
- Overall length 89mm 50mmØ



SBFBA-5BWW

- Ball, Warm White 2700K
- Overall length 89mm 50mmØ



SBFBA-11EWW

- Ball, Warm White 2700K
- Overall length 121mm 70mmØ



SBFBA-11BWW

- Ball, Warm White 2700K
- Overall length 121mm 70mmØ



SBFBA-20EWW

- Ball, Warm White 2700K
- Overall length 155mm 100mmØ



SBFBA-20BWW

- Ball, Warm White 2700K
- Overall length 155mm 100mmØ



SBF300-8PWW

- Self ballasted compact fluorescent
- Warm White 2700K
- 300mmL



SBF500-13PWW

- Self ballasted compact fluorescent
- Warm White 2700K
- 500mmL



SBF80-13EWW

- Warm White 2700K
- 119mmL x 80mmØ



SBF30-15ECW

- Cool White 4000K
- 125mmL x 95mmØ









Fluorescent Lamps & Tubes

• We are able to supply the following lamps from our warehouse • Lengths stated exclude pins

T5 MINIATURE FLUORESCENT LAMPS

84 lm/W

T5











 SFT5-CW8 8watt Cool White (4,000k) 288mm	
 SFT5-CW13 13watt Cool White (4,000k) 518mm	(or) SFT5-DL13 13watt Daylight (6,400k)
 SFT5-CW14 14watt Cool White (4,000k) 549mm	
 SFT5-CW21 21watt Cool White (4,000k) 848mm	(or) SFT5-DL21 21watt Daylight (6,400k) (or) SFT5-BLB21 21watt Blacklight Blue
 SFT5-GN21 21watt Green	
 SFT5-BE21 21watt Blue	
 SFT5-CW28 28watt Cool White (4,000k) 1148mm	(or) SFT5-DL28 28watt Daylight (6,400k)
 SFT5-CW35 35watt Cool White (4,000k) 1450mm	(or) SFT5-DL35 35watt Daylight (6,400k)

21 Watt Blacklight

SFT4 MINIATURE FLUORESCENT LAMPS

Wattages to match SFT4 series fittings

T4







 SFT4-DL6 6watt Daylight (6,400k) 208mm	
 SFT4-BE6 6watt Blue	
 SFT4-GN6 6watt Green	
 SFT4-RD6 6watt Red	
 SFT4-DL8 8watt Daylight (6,400k) 328mm	
 SFT4-DL16 16watt Daylight (6,400k) 458mm	
 SFT4-DL20 20watt Daylight (6,400k) 556mm	
 SFT4-BE20 20watt Blue	
 SFT4-GN20 20watt Green	
 SFT4-RD20 20watt Red	

84 lm/W

CIRCULAR LAMPS

T9





55 lm/W

 CIR-40-TP 40watt Triphos 5,000k Daylight	 CIR-40-WW 40watt Triphos 3,500k Warm White
 CIR-32-TP v32watt Triphos 5,000k Daylight	 CIR-32-WW 32watt Triphos 3,500k Warm White
 CIR-22-TP 22watt Triphos 5,000k Daylight	 CIR-22-WW 22watt Triphos 3,500k Warm White

SFM-T4 MINIATURE FLUORESCENT LAMPS

Wattages to match SFM series fittings

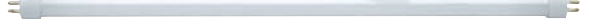
84 lm/W

 SFM-T4-7-WW 7watt Warm-White (3,450k) 218mm
 SFM-T4-10-WW 10watt Warm-White (3,450k) 292mm
 SFM-T4-18-WW 18watt Warm-White (3,450k) 470mm
 SFM-T4-18-RD 18watt Red
 SFM-T4-18-BE 18watt Blue
 SFM-T4-18-GN 18watt Green

T8 FLUORESCENT LAMPS

 SFT8-BLB36 36watt Blacklight Blue 1200mmL

Halogen Reflector Lamps

10 lm/W

ALUMINISED MAINS VOLTAGE



2,500 Hours life 230V-240V

50W 36°

GU10-50-A
Aluminised, 50mmØ

35W 36°

GU10-35-A
Aluminised, 50mmØ

75W 30°

GU10-75-A
Aluminised, 63mmØ

DICHROIC 12V



3,000 Hours life with cover glass 12v

MRE16-35-D38 (35w)
Energy saving High Intensity Halogen, equivalent light output of 50watt old Technology lamps for 35watts of power.



111mm HALOGEN 12V



MAX. 100W G53

RL111-75-24
For 111mmØ Halogen fittings, 24°
Supplied with 75 watt capsule lamp
Open reflector lamp.

- Supplied with 75 watt capsule how ever other wattage halogen capsule lamps can be fitted in this reflector.

HALOGEN CAPSULES MAINS VOLTAGE



G9-25F
G9-40F
G9-50F

HDE100-E27
HDE150-E27

15 lm/W

25W 40W 50W G9

G9-25F (frosted 25w)
G9-40F (frosted 40w)
G9-50F (frosted 50w)
1500 hours life

100W 150W 230V-240V E27

HDE100-E27
HDE150-E27
Double envelope bulb

Mains Voltage / LED Lamps



• Replaces traditional technology lamps

CANDLE LED LAMPS



NEW

B22 **230V-240V** **4 Watt**

CANP-4BWW

- 3,000k Warm white
- 37mmØ
- 100mm overall length
- 210° degree beam angle
- CRI 80
- 280 lumens
- Ceramic



NEW

E14 **230V-240V** **4 Watt**

CANP-4SEWW

- 3,000k Warm white
- 37mmØ
- 106mm overall length
- 210° degree beam angle
- CRI 80
- 280 lumens
- Ceramic



NEW

E14 **230V-240V** **3 Watt**

CANC-3SEWW

- 3,000k Warm white
- 35mmØ
- 98mm overall length
- 270° degree beam angle
- CRI 80
- 300 lumens

G9 AND R7S LED



NEW

230V-240V **G9** **3 Watt**

G9-3WLED-WW



NEW

230V-240V **R7s 78** **6 Watt**

LIN78-6WLED-CW



NEW

230V-240V **R7s 118** **12 Watt**

LIN118-12WLED-CW

230V-240V **G9** **3 Watt**

- G9-3WLED-WW**
- Warm white
 - 3,000k
 - 50mmH x 15mmØ
 - 360° multi directional light effect
 - 200 lumens

230V-240V **R7s 78** **6 Watt**

- LIN78-6WLED-CW**
- Natural white
 - 4,000k
 - 78mmL x 58mmH x 32mmD
 - 600 lumens
 - Similar light effect to a 60watt halogen

230V-240V **R7s 118** **12 Watt**

- LIN118-12WLED-CW**
- Natural white
 - 4,000k
 - 118mmL x 58mmH x 34mmD
 - 1200 lumens
 - Similar light effect to a 120watt halogen

12v LED Capsule Lamps



• Constant voltage • 12Volt AC, CCG or ECG • 12 volt DC

1.5 WATT CAPSULE



NEW

G 4.0 **12v** **1.5 Watt**

CAP-1WLED-WW

- 3,000k Warm white
- 9mmØ
- 35mm overall length
- 360° degree beam angle
- CRI 80
- 90 lumens

3 WATT CAPSULE



NEW

G 4.0 **G5.3** **3 Watt**

CAP-3WLED-WW

- 3,000k Warm white
- 12mmØ
- 36mm overall length
- 360° degree beam angle
- CRI 80
- 150 lumens

G 4.0 **G5.3** **3 Watt**

- CAP-3WLED-WW**
- 3,000k Warm white
 - 12mmØ
 - 36mm overall length
 - 360° degree beam angle
 - CRI 80
 - 150 lumens

- 12volt LED lamps are compatible with most types of Halogen transformers, Best results with lower wattage transformers.
- Some single lamp installations are not best supplied by AC, ECG
- Not suitable for some boat and motor home installations

Mains Voltage / LED Lamps



• Replaces traditional technology lamps

GLS STANDARD



Multi Dimmable

GLSD-6EWW



NEW

GLSC-6EWW



NEW

GLSC-6BWW

E27 **230V-240V** **6 Watt**

- GLSD-6EWW**
- Dimmable
 - 3,000K Warm White
 - 58mmØ
 - 111mm overall length
 - 270° degree beam angle
 - CRI 81
 - 450 lumens

E27 **230V-240V** **6 Watt**

- GLSC-6EWW**
- 3,000K Warm White
 - 55mmØ
 - 98mm overall length
 - 270° degree beam angle
 - CRI 80
 - 600 lumens

B22 **230V-240V** **6 Watt**

- GLSC-6BWW**
- 3,000K Warm White
 - 55mmØ
 - 98mm overall length
 - 270° degree beam angle
 - CRI 80
 - 600 lumens

SMALL GLOBES



NEW

SMR-5EWW

E27 **230V-240V** **5 Watt**

- SMR-5EWW**
- 3,000K Warm White
 - 53mmØ
 - 83mm overall length
 - 210° degree beam angle
 - CRI 80
 - 425 lumens
 - Ceramic

R80 LAMPS



Dimmable

R80D-10EWW



IDEAL For CA Downlight upgrade

NEW

R80-10EWW

E27 **230V-240V** **10 Watt**

- R80D-10EWW**
- Dimmable
 - 3,000K Warm White
 - 80mmØ
 - 110mm overall length
 - 120° degree beam angle
 - CRI 80
 - 750 lumens

E27 **230V-240V** **10 Watt**

- R80-10EWW**
- 3,000K Warm White
 - 80mmØ
 - 110mm overall length
 - 120° degree beam angle
 - CRI 80
 - 750 lumens

63° BEAM ANGLE



NEW

PAR38-12WLED-WW

E27 **230V-240V** **12 Watt**

- PAR38-12WLED-WW**
- Warm White
 - 3,000k
 - 122mmØ
 - 64 Lux at 2.4metres
 - Outdoor and indoor use
 - 1000 Lumens
 - Non-dimmable

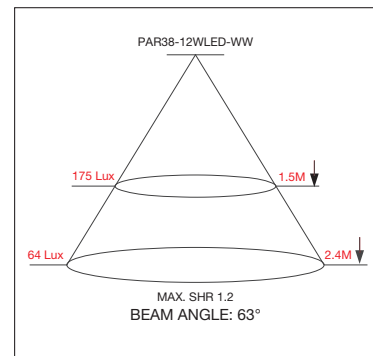

22° BEAM ANGLE



Sealed Glass Envelope

PAR38-LED-WH

E27 **230V-240V** **4 Watt**

- PAR38-LED-WH**
- Warm White
 - 3,000k
 - 122mmØ
 - 60 Lux at 2.4metres
 - Outdoor and indoor use
 - 198 Lumens
 - Non-dimmable

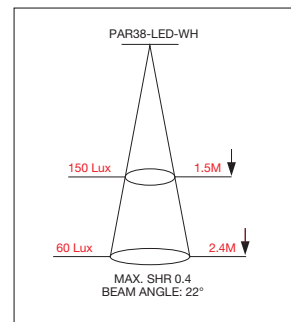

Mains Voltage / Reflector Lamps



• Replaces traditional technology lamps

30° BEAM



GU10-HPLED-WH

230V-240V GU10 5 Watt

GU10-HPLED-WH

- Warm white
- 3,000k
- 58 Lux at 2.4metres
- 50mmØ
- Credible performance original CREE X lamp
- 300 lumens

30° BEAM DIMMABLE



GU10D-5LED-WW

230V-240V GU10 5 Watt

GU10D-5LED-WW

- Dimmable
- Warm white
- 3,000k
- 134 Lux at 2.4metres
- 50mmØ
- 8mm longer than standard GU10 lamps
- 340 lumens

36° BEAM



GU10-WBLED-WW

230V-240V GU10 5 Watt

GU10-WBLED-WW

- Warm white
- 3,000k
- 118 Lux at 2.4metres
- 50mmØ
- Credible performance original CREE X lamp
- 310 lumens

15° BEAM



GU10-LED-WH

230V-240V GU10 1.7 Watt

GU10-LED-WH

- White
- 40 Lux at 2.4metres
- 4,000k
- 50mmØ
- 51 lumens

12v LED Reflector Lamp



• Replaces Halogen lamps • **Constant Voltage** • 12 volt AC, CCG, or ECG

36° BEAM



MR16-WBLED-WW

MR16 CV 12V

5 Watt G 5.3

MR16-WBLED-WW

- Warm white
- 3,000k
- 50mmØ
- 75 lux at 2.4metres
- Credible performance original CREE X lamp
- 210 Lumens

38° BEAM



MR16-HPLED-WH

MR16 CV 12V

6 Watt G 5.3

MR16-HPLED-WH

- Warm white
- 3,000k
- 176 Lux at 2.4metres
- 50mmØ
- 480 Lumens

26° BEAM



MR16-NBLED-WW

MR16 CV 12V

5 Watt G 5.3

MR16-NBLED-WW

- Warm white
- 3,000k
- 212 Lux at 2.4metres
- 50mmØ
- 425 Lumens

15° BEAM



MR16-LED-WH

1.5 Watt MR16

CV 12V G 5.3

MR16-LED-WH

- White
- 42 Lux at 2.4metres
- 4,000k
- 50mmØ
- 55 Lumens

Notes

Notes

Notes

PRODUCT	PAGE	PRODUCT	PAGE	PRODUCT	PAGE	PRODUCT	PAGE	PRODUCT	PAGE
720-22	74	DFS-21	50	DUAL600-JOIN	45	FLF-BL	4	LDLB70-BL	16
720-32	74	DFS-28	50	DUAL6-CA	44	FL-LOUVRE	4	LDLB70-SC	16
720-40	74	DFS-8	50	DUAL6-DIF	45	FLUSH-D	131	LDLB70-WH	16
720-72	74	DFSM-18-SC	55	DUAL-DIM	44	FLUSH-O	131	LDLB90-FIRE60	17
721-22	74	DFSM-18-WH	55	DUAL-FEED	44	FLUSH-S	131	LDLB90-GD	17
721-32	74	DFSM-30-SC	55	DU10730-BL	113	FS4996	116	LDLB90-SC	17
721-40	74	DFSM-30-WH	55	DU4510-BZ	118	FS4997	116	LDLB90-WH	17
721-72	74	DFSM-36-SC	55	DU4510-SI	118	G1453	57	LDL-GIM1-SI	12
724-32	74	DFSM-36-WH	55	DU5710-BZ	119	G9-25F	135	LDL-GIM1-WH	12
787-10	70	DFT-14	50	DU5710-SI	119	G9-3WLED-WW	136	LDL-GIM2-SI	12
787-14	70	DFT-21	50	DU6002-BZ	118	G9-40F	135	LDL-GIM2-WH	12
B062-BL	112	DFT-8	50	DUF80-BL	115	G9-50F	135	LDL-GIM3-SI	12
B062-WH	112	DF-WIRE	55/66	DUH377-BR	108	GLSC-6BWW	137	LDL-GIM3-WH	12
BAL-T922	131	DIVA1-DL	40	DUP377-BR	108	GLSC-6EWW	137	LDL-GIM4-SI	12
BAL-T932	131	DIVA1-DIF	41	DUP7010-BL	110	GLSD-6EWW	137	LDL-GIM4-WH	12
BAL-T940	131	DIVA1-FLEX-DL	40	DUP7030-BL	110	GU10-35-A	135	LDL-IP54-SI	15
BZF-104L-BL	115	DIVA1-FLEX-WW	40	DUT6002-BZ	118	GU10-50-A	135	LDL-IP54-WH	15
BZ-FLANGE	114	DIVA1-WW	40	DUT8302-BL	111	GU10-75-A	135	LDL-IP55-WH	14
BZ-POLE1-BL	114	DIVA11-DL	40	DUW2000-BZ	119	GU10D-5LED-WW	138	LDLS130-WH	13
BZ-POLE2-BL	114	DIVA11-DIF	41	DUW2000-SI	119	GU10-HPLED-WH	138	LDLX100-WH	13
BZ-POLE60-BL	114	DIVA11-WW	40	DUW377-BR	108	GU10-LED-WH	138	LIN78-6WLED-CW	136
C4025L-BL	115	DIVA1200-JOIN	41	DUW4000-BZ	118	GU10-WBLED-WW	138	LIN118-12WLED-CW	136
CANC-3SEWW	136	DIVA15-DL	40	DUW4000-SI	118	GV-S06-GE	116	LJ4051-BL	106
CANP-4BWW	136	DIVA15-DIF	41	DUW577-BL	111	GV-T60	131	LJ4051-WH	106
CANP-4SEWW	136	DIVA15-WW	40	DUW700-WH	109	HDE100-E27	135	LJ6000-CON	102
CAP-1WLED-WW	136	DIVA150-JOIN	41	DUW7010-BL	110	HDE150-E27	135	LJ6001-BL	103
CAP-3WLED-WW	136	DIVA1800-JOIN	41	DUW7030-BL	110	HOL3S-BS	54	LJ6001-CO	103
CENT10	6	DIVA300-JOIN	41	DUW8100-WH	109	HOL3S-CH	54	LJ6001-GN	103
CENT10-CAGE	6	DIVA3-DL	40	DUW8302-BL	111	HOL3S-WH	54	LJ6001-SG	103
CIR-22-TP	134	DIVA3-DIF	41	EER65	130	HOL5S-BS	54	LJ6001-SS	104
CIR-22-WW	134	DIVA3-WW	40	EES100	130	HOL5S-CH	54	LJ6001-WH	103
CIR-32-TP	134	DIVA-4015CLIP	41	EES80	130	HOL5S-WH	54	LJ6002-BL	103
CIR-32-WW	134	DIVA4-DL	40	EE0150	130	HOL7S-BS	54	LJ6002-CO	103
CIR-40-TP	134	DIVA4-DIF	41	EE0240	130	HOL7S-CH	54	LJ6002-GN	103
CIR-40-WW	134	DIVA4-WW	40	F1060-SI	113	HOL7S-WH	54	LJ6002-SG	103
CL205-36	77	DIVA600-JOIN	41	F3725-BL	37	HOL-CNR	54	LJ6002-SS	104
CL205-52	77	DIVA7-DL	40	F3725-WH	37	HOL-JOIN	54	LJ6002-WH	103
CL207-36	77	DIVA7-DIF	41	F3729-BL	37	KDU15-BL	124	LJ6003-BL	103
CL207-52	77	DIVA7-WW	40	F3729-WH	37	KG20-BL	121	LJ6003-CO	103
CL2220-CH	71	DIVA-DIM	41	F3733-BL	37	KP150-BL	123	LJ6003-GN	103
CL2257-CH	71	DIVA-FEED	40	F3733-WH	37	KP300-BL	123	LJ6003-SG	103
CL320-14	72	DLA-12	51	F5301-BL	112	KPDS150-BL	123	LJ6003-WH	103
CL320-24	72	DLA-18	51	F5301-WH	112	KPDS300-BL	123	LJ6004-BL	103
CL5003-8	71	DLA-8	51	F5894L-BL	114	KR10-BL	120	LJ6004-CO	103
CP1041-1P-CH	93	DLED24-15	38/42	F6601-SI	33	KR10-SI	120	LJ6004-GN	103
CP110-CH	95	DLED24-30	42	F6601-WH	33	KR10-WH	120	LJ6004-SG	103
CP2176-BZ	86	DLED24-75	42	F6602-SI	33	KR30-SI	121	LJ6004-WH	103
CP226-L	93	DLS-12	51	F6602-WH	33	KR50-SI	122	LJ6051-BL	105
CP226-R6	93	DLS-8	51	F6603-SI	33	KR100-SI	122	LJ6051-SS	105
CR1861-1B	83	DLT-12	51	F6603-WH	33	KS300-BL	123	LJ6051-WH	105
DF-18-SC	55	DLT-8	51	F7301-BL	112	KS300-WH	123	LJF4051-BL	106
DF-18-WH	55	DUAL1200-JOIN	45	F7301-WH	112	KSG20-BL	121	LJF4051-WH	106
DF-30-SC	55	DUAL12-CA	44	FB3690-BL	106	KSR10-BL	120	LJF6001-BL	103
DF-30-WH	55	DUAL12-DIF	45	FB3692-BL	106	KSR10-SI	120	LJF6001-CO	103
DF-36-SC	55	DUAL150-JOIN	45	FB3693-BL	106	KSR10-WH	120	LJF6001-GN	103
DF-36-WH	55	DUAL1800-JOIN	45	FB3720	37	KSR30-SI	121	LJF6001-SG	103
DFA-14	50	DUAL18-CA	44	FB-60	131	LDL80-WH	10	LJF6001-SS	104
DFA-21	50	DUAL18-DIF	45	FB6931	114	LDL90-WH	10	LJF6001-WH	103
DFA-28	50	DUAL24-CA	44	FB6932-BL	114	LDL100-CH	10	LJF6002-BL	103
DFA-8	50	DUAL24-DIF	45	FB6960-BL	106	LDL100-WH	10	LJF6002-CO	103
DFL-14	50	DUAL300-JOIN	45	FB69611	110	LDL125-WH	10	LJF6002-GN	103
DFL-21	50	DUAL3-CA	44	FB6962-BL	106	LDL160-WH	11	LJF6002-SG	103
DFL-8	50	DUAL3-DIF	45	FL- WH	4	LDL175-WH	11	LJF6002-SS	104
DFS-14	50	DUAL-4015CLIP	45	FL-BL	4	LDL210-WH	11	LJF6002-WH	103

PRODUCT	PAGE	PRODUCT	PAGE	PRODUCT	PAGE	PRODUCT	PAGE	PRODUCT	PAGE
LJF6003-BL	103	LK2332-WH	36	MR16-LED-WH	138	QH2301	96	SBFBA-5SEWW	133
LJF6003-CO	103	LK2333-CC	36	MR16-NBLED-WW	138	QH290	99	SBFSP-14BWW	132
LJF6003-GN	103	LK2333-SI	36	MR16-WBLED-WW	138	QH300-AB	94	SBFSP-14EWW	132
LJF6003-SG	103	LK2333-WH	36	MRE16-35-D38	135	QH300-SC	94	SBFSP-26EWW	132
LJF6003-WH	103	LK3050	101	MS1021-BA	92	QH400	99	SBFSP-7EWW	132
LJF6004-BL	103	LK3051-CC	101	MS15102-BA	91	QH420-SC	94	SBFSP-7SEWW	132
LJF6004-CO	103	LK3051-SI	101	MS2254-CH	93	QH4803	97	SC4005	61
LJF6004-GN	103	LK3051-WH	101	MS250-BZ	90	QH5016	96	SC4006	61
LJF6004-SG	103	LK3052-CC	101	MS250-CO	90	QH9040	96	SC705-BL	61
LJF6004-WH	103	LK3052-SI	101	MS250-NI	90	R1041-1B-SC	88	SC705-WH	61
LJF6051-BL	105	LK3052-WH	101	MS27902-BA	91	R1042-2C-SC	88	SC706-BL	61
LJF6051-SS	105	LKS3050	101	MS29020-BA	91	R1043-3P-SC	88	SC706-WH	61
LJF6051-WH	105	LLED10006-SS	30	MS312-SI	92	R1044-1P-SC	88	SCD25-TLT-SI	14
LJL6001-BL	103	LRL133-SC	30	MS320-BZ	90	R1765-5C-CH	95	SCD25-TLT-WH	14
LJL6001-CO	103	LRL133-WH	30	MS320-CO	90	R2769-9P-CH	95	SD-DIF-SBF	22
LJL6001-GN	103	LRL233-SC	31	MS320-NI	90	R3151-1B-AB	86	SD-FG-SC	22
LJL6001-SG	103	LRL233-WH	31	MS336-BA	92	R4301-1P-AB	89	SD-FG-WH	22
LJL6001-SS	104	LSA-BL	2	MS34202-BA	92	R4301-1P-SC	89	SD-MASTIC	131
LJL6001-WH	103	LSA-SI	2	MS349-BA	92	R4581-1P-AB	86	SD-RING-BL	20
LJL6002-BL	103	LSA-WH	2	MS350-BZ	90	R4581-1P-BL	86	SD-RING-CR	20
LJL6002-CO	103	LSB-BL	2	MS350-CO	90	R4581-1P-SC	86	SD125-BLBL	20
LJL6002-GN	103	LSB-SI	2	MS350-NI	90	R5331-1B-AB	89	SD125-GDBL	20
LJL6002-SG	103	LSB-WH	2	MS70357-CO	91	R5331-1B-SC	89	SD125-GDWH	20
LJL6002-SS	104	LSC-BL	2	MS70357-SC	91	R5787-1P-AB	89	SD125-LFL-SC	22
LJL6002-WH	103	LSC-SI	2	MS70358-CO	91	R5787-1P-SC	89	SD125-LFL-WH	22
LJL6003-BL	103	LSC-WH	2	MS70358-SC	91	R6436-2C-AB	86	SD125-SCBL	20
LJL6003-CO	103	LSD-WH	9	ND100-BL	128	R80-10EWW	137	SD125-SCWH	20
LJL6003-GN	103	LSH-WH	6	ND100-WH	128	R80D-10EWW	137	SD125-WHWH	20
LJL6003-SG	103	LSLC-B2-CH	58	ND180-BL	128	R900-1P-AB	86	SD125-FIRE60	20
LJL6003-WH	103	LSLC-B3-CH	58	ND180-WH	128	R9351-1B-AB	87	SD125F-FIRE60	21
LJL6004-BL	103	LSLC-B4-CH	58	ND360	129	R9352-2B-AB	87	SD125F-GD	21
LJL6004-CO	103	LSLC-P1-CH	58	ND365	129	R9353-3P-AB	87	SD125F-SC	21
LJL6004-GN	103	LSLT-B2-CH	59	P21-BB	84	R9355-5P-AB	87	SD125F-WH	21
LJL6004-SG	103	LSLT-B3-CH	59	P21-SC	84	RL111-75-24	135	SD130-SC	18
LJL6004-WH	103	LSLT-P1-CH	59	P28-BB	84	RS2001-1	56	SD130-WH	18
LJS6003-BL	103	LSM-11-CH	3	P28-SC	84	RS2001-2	56	SD153-SC	19
LK1401	35	LSM-12-CH	3	P2984-AB	81	RS2001-3	56	SD153-WH	19
LK1403	35	LSM-14-WH	8	P2984-SC	81	RS2001-4	56	SDC-LFL-BL	23
LK1441-CC	35	LSM-15-WH	8	P33-BB	84	RS2002	56	SDC-LFL-CR	23
LK1441-SI	35	LSM-16-WH	8	P33-SC	84	RS2003	56	SDC-LFL-GD	23
LK1441-WH	35	LSM-1-BL	3	PAR38-12WLED-WW	137	RS2004	56	SDC-LFL-SC	23
LK1443-CC	35	LSM-1-WH	3	PAR38-LED-WH	137	RS2005	56	SDC-LFL-WH	23
LK1443-SI	35	LSM-2-BL	3	PD35-CH	84	RS2006	56	SDC-TLT-BL	23
LK1443-WH	35	LSM-2-WH	3	PD35-WH	84	RS2007	57	SDC-TLT-CR	23
LK1501	34	LSM-3H-BL	3	PD8163-BS	84	RS2008	57	SDC-TLT-GD	23
LK1503	34	LSM-3H-WH	3	PD8163-CH	84	RS2009	57	SDC-TLT-SC	23
LK1551-CC	34	LSM-4-BL	3	PF418-SI	60	RS2010	57	SDC-TLT-WH	23
LK1551-SI	34	LSM-4-WH	3	PF60-SC	60	RS-NUT10	56	SDF235-SI	32
LK1551-WH	34	LSM-5-BL	3	PS300	98	SA-B2-CH	65	SDFS118-WH	23
LK1553-CC	34	LSM-5-WH	3	PS350	98	SA-P1-CH	65	SDU235-SI	32
LK1553-SI	34	LSM-7-BL	3	PS400	98	SB1450	107	SDV220-SI	32
LK1553-WH	34	LSM-7-SI	3	PS410	98	SB1610	107	SDV76-SI	32
LK2240	100	LSM-7-WH	3	PS480	98	SB1650	107	SFE-10CS	48
LK2241-CC	100	LSM-8-CH	3	PS600	98	SBF30-15ECW	133	SFE-15	48
LK2241-SI	100	LSM-9ROD-BL	3	PS760	98	SBF300-8PWW	133	SFE-18	48
LK2241-WH	100	LSM-9ROD-WH	3	Q925	56	SBF3U-15EWW	132	SFE-18CS	48
LK2301	36	LSN-WH	8	QH1011	96	SBF4U-65EDL	132	SFE-30	48
LK2302	36	LSP-WH	9	QH1172	96	SBF500-13PWW	133	SFE-36	48
LK2303	36	LSS-WH	9	QH200	99	SBFBA-11BWW	133	SFM-T4-10-WW	134
LK2331-CC	36	LSX	5	QH2123-1	94	SBFBA-11EWW	133	SFM-T4-18-BE	134
LK2331-SI	36	LSX-GLASS	5	QH2123-3	94	SBF80-13EWW	133	SFM-T4-18-GN	134
LK2331-WH	36	LSX-LENS	5	QH2183	96	SBFBA-20BWW	133	SFM-T4-18-RD	134
LK2332-CC	36	LSZ	5	QH2193-WH	97	SBFBA-20EWW	133	SFM-T4-18-WW	134
LK2332-SI	36	MR16-HPLED-WH	138	QH2198-WH	97	SBFBA-5BWW	133	SFM-T4-7-WW	134

PRODUCT	PAGE	PRODUCT	PAGE	PRODUCT	PAGE	PRODUCT	PAGE	PRODUCT	PAGE
SFT4-16	52	SH-P2-SC	63	SV-ROPE5-58	68	TK121-BL	67	WL167-WH	73
SFT4-20	52	SH-P2-WH	63	SV-ROPE5-98	68	TK121-SI	67	WL170-BL	73
SFT4-6	52	SH-P3-BL	63	SV-STLT1-SI	28	TK121-WH	67	WL170-WH	73
SFT4-8	52	SH-P3-BS	63	SV-STLT1-WH	28	TK-2000-BL	66	WL2022	82
SFT4-BE20	134	SH-P3-SC	63	SV-STLT2-SI	28	TK-2000-SI	66	WL2070	82
SFT4-BE6	134	SH-P3-WH	63	SV-STLT2-WH	28	TK-2000-WH	66	WL2109-L	76
SFT4-C150	49/52	SK-B2-SC	64	SV-STLT3-SI	28	TK206-BL	67	WL2109-S	76
SFT4-C1600	49/52	SK-B3-SC	64	SV-STLT3-WH	28	TK206-SI	67	WL2198	82
SFT4-C1800	49/52	SK-P1-SC	64	SV-STLT4-SI	28	TK206-WH	67	WL2252-WH	85
SFT4-C300	49/52	SLED-C19AM	46	SV-STLT4-WH	28	TK21-BL	67	WL308-BL	127
SFT4-C600	49/52	SLED-C19BE	46	SV-SWGD-CH	25	TK21-SI	67	WL308-SG	127
SFT4-DL16	134	SLED-C19GN	46	SV-SWGD-GD	25	TK21-WH	67	WL308-WH	127
SFT4-DL20	134	SLED-C19RD	46	SV-SWGD-WH	25	TK51-BL-BL	67	WL309-BL	127
SFT4-DL6	134	SLED-C19WH	46	SV-TLTL-GD	25	TK51-SI	67	WL309-SG	127
SFT4-DL8	134	SLED-DIM	42/47	SV-TLTL-SC	25	TK51-WH-WH	67	WL309-WH	127
SFT4-GN20	134	SLED-EC15	47	SV-TLTL-WH	25	TK-CORNER-BL	66	WL3091-CH	83
SFT4-GN6	134	SLED-EC5	47	SV133-SC	30	TK-CORNER-SI	66	WL320-8	72
SFT4-PLUGS	49/52	SLED-EXT2	38	SV133-WH	30	TK-CORNER-WH	66	WL3361	85
SFT4-RD20	134	SLED-FEED	47	SVE-SDL-SS	25	TK-CROSS-BL	66	WL3371	85
SFT4-RD6	134	SLED-JOIN	47	SVE-SDL-WH	25	TK-CROSS-WH	66	WL3721	78
SFT5-13	53	SLED-R2WH	31	SVE-T50	131	TK-END-BL	66	WL4274	80
SFT5-21	53	SLED-RT2WH	31	SVE-T60	131	TK-END-SI	66	WL4337	83
SFT5-28	53	SLED-S12AM	47	SVE-T70	131	TK-END-WH	66	WL-611	82
SFT5-35	53	SLED-S12BE	47	SVE-T200	131	TK-JOIN-BL	66	WL-621	82
SFT5-BE21	134	SLED-S12GN	47	SVE-TLT-SS	25	TK-JOIN-SI	66	WL8436	80
SFT5-BLB21	134	SLED-S12RD	47	SVE90-BL	26	TK-JOIN-WH	66	WL8447	80
SFT5-C001	53	SLED-S12WH	47	SVE90-CR	26	TK-ROD-SC	66	WL8834	80
SFT5-C150	53	SLED-SQ6AM	46	SVE90-FIRE60	27	TK-TEE-BL	66	WLC2161	78
SFT5-C1800	53	SLED-SQ6BE	46	SVE90-GD	26	TK-TEE-SI	66	WLL9287-BL	79
SFT5-C300	53	SLED-SQ6GN	46	SVE90-SC	26	TK-TEE-WH	66	WLL9287-RD	79
SFT5-C600	53	SLED-SQ6RD	46	SVE90-WH	26	TKL401-BL	67	WLL9287-WH	79
SFT5-CW13	134	SLED-SQ6WH	46	SVE90S-FIRE60	27	TKL401-SI	67	WLR2161	85
SFT5-CW14	134	SLT4-300	49	SVE90S-GD	27	TKL401-WH	67	WLS2155-WH	78
SFT5-CW21	134	SLT4-600	49	SVE90S-SC	27	TKL503-BL	67	WLS9287-BL	79
SFT5-CW28	134	SLT4-900	49	SVE90S-WH	27	TKL503-SI	67	WLS9287-RD	79
SFT5-CW35	134	SLT4-1200	49	SVU-10-BS	30	TKL503-WH	67	WLS9287-WH	79
SFT5-CW8	134	SMR-5EWW	137	SVU-10-SC	30	TLED24-BL	7	WS240-BL	124
SFT5-DL13	134	SSL35-BL	125	SVU-10-WH	30	TLED24-CH	7	WS240-CH	124
SFT5-DL21	134	SSL35-WH	125	SY-B2-SG	64	TLED84-BLSI	7		
SFT5-DL28	134	SUDLED4-BL	38	SY-B2-WH	64	TLED85-WHSI	7		
SFT5-DL35	134	SUDLED4-GD	38	SY-P1-SG	64	TRIM-22-BC	75		
SFT5-GN21	134	SUDLED4-SI	38	SY-P1-WH	64	TRIM-22-BS	75		
SFT5-PLUGS	53	SUDLED4-WH	38	SY-P3-SG	64	TRIM-22-WH	75		
SFT8-BLB36	134	SUDLED4-CLIP	38	SY-P3-WH	64	TRIM-32-BC	75		
SG-B2-CH	65	SUDR-BL	38	TE1000-SI	69	TRIM-32-BS	75		
SG-P1-CH	65	SUDR-GD	38	TE100-300-SC	69	TRIM-32-WH	75		
SH-B2-BL	62	SUDR-SI	38	TE100-SC	69	TRIM-40-BC	75		
SH-B2-BS	62	SUDR-WH	38	TE101-SC	69	TRIM-40-BS	75		
SH-B2-SC	62	SV-DISK-BE	68	TE102-SC	69	TRIM-40-WH	75		
SH-B2-WH	62	SV-GMR1-SG	29	TE103-300-SC	69	TRIM90FG-SC	26		
SH-B3-BL	62	SV-GMR1-WH	29	TE103-SC	69	TRIM90FG-WH	26		
SH-B3-BS	62	SV-GMR2-SG	29	TE2000-SI	69	TRIM-C22-BC	75		
SH-B3-SC	62	SV-GMR2-WH	29	TE300-SC	69	TRIM-C22-BS	75		
SH-B3-WH	62	SV-GMR3-SG	29	TE630-SC	69	TRIM-C22-WH	75		
SH-B4-BL	62	SV-GMR3-WH	29	TE-BEND-SI	69	TRIM-C32-BC	75		
SH-B4-BS	62	SV-GMR4-SG	29	TE-CORNER-SI	69	TRIM-C32-BS	75		
SH-B4-SC	62	SV-GMR4-WH	29	TE-END-SI	69	TRIM-C32-WH	75		
SH-B4-WH	62	SV-IP55-SS	15	TE-FEED-SI	69	WBF110	117		
SH-P1-BL	63	SV-IP65-SC	15	TE-JOIN-SI	69	WBF145	117		
SH-P1-BS	63	SV-IP65-WH	15	TE-ROD-SI	69	WBP110	117		
SH-P1-SC	63	SV-PILLAR	68	TE-TEE-SI	69	WBP145	117		
SH-P1-WH	63	SV-POST	68	TK-1000-BL	66	WL1602	81		
SH-P2-BL	63	SV-ROPE3-92	68	TK-1000-SI	66	WL1606	81		
SH-P2-BS	63	SV-ROPE5-23	68	TK-1000-WH	66	WL167-SI	73		



superlux
we engineer light

Specifiers Product Guide:

10

This catalogue introduces our complete range of lighting and electrical products and replaces all previous catalogues.



Specify Superlux for Your Peace of Mind!

You can specify Superlux Lighting and Electrical products with confidence.

Guaranteed quality and a wide range of choice has been the key to the success of Superlux for over half a century, and the company is committed to the evolving field of lighting.

The Superlux difference, many of the products in this catalogue are designed and manufactured by Superlux. We are excited to produce products which are innovative and designed with benefits such as easier installation and superior performance for our Australian and New Zealand customers. We are not reliant on local production alone and search the world for the best and most Up-to-date manufacturing facilities.

From our Sydney warehousing facility we offer a comprehensive choice of quality lighting products from Australasia and around the world.

1. FULL TERMS & CONDITIONS OF SALE

are available on request.

2. GENERAL

Goods are sold on the condition that the reseller is familiar with the technical information contained in this catalogue, relevant electrical codes of practice, wiring rules and is suitably knowledgeable with this type of lighting to make the correct product choice.

3. RECEIPT OF GOODS

Superlux Pty Limited is responsible for goods only up until they are received into your care. It is important that any external damage to packaging is recorded on the courier documentation when signing. It will be the responsibility of the customer to check deliveries for damages and notify the company within 48 hours of any damage caused by delivery for the company to make claims against the carrier. Non-delivery – any shipments that fail to arrive or have items missing must be reported within 5 working days. Once goods have left your store no claims for missing goods can be accepted.

4. CUTTING OF HOLES

For reasons beyond our control, specifications may change

without notice. As such, the cutting of holes or other installation / constructional work prior to receiving product is entirely at the purchaser's risk.

5. SPLIT DELIVERIES

For reasons beyond our control, specifications may change regularly. As such, split deliveries run the risk of model changes and / or supply issues and are entirely at the purchaser's risk.

6. GUARANTEE

We put considerable effort into ensuring our products are made to meet or exceed the relevant standards. Should a product fail due to defects in materials or workmanship, we will either repair or replace it at our discretion. If this is not possible then we will offer an alternative product as replacement. The guarantee does not cover products damaged due to wrong selection, misuse or incorrect installation. The guarantee period is normally 12-months from despatch; however, on some products this may be extended. Superlux Pty Limited accepts no claims for indirect or consequential damages whether based on contract, tort or any other legal theory.

E & OE: Errors and Omissions Excepted.

Declaration of Compliance with Standards

Superlux is committed to the electrical safety of all products sold, and in addition to our in-house engineering facilities we utilise the independent services of Laboratories to verify product compliance.

Where required by Australian and New Zealand regulations, our products also have necessary regulatory approvals and/or declarations.



superlux
we engineer light

PRODUCT	PAGE	PRODUCT	PAGE	PRODUCT	PAGE	PRODUCT	PAGE	PRODUCT	PAGE
SFT4-16	52	SH-P2-SC	63	SV-ROPE5-58	68	TK121-BL	67	WL167-WH	73
SFT4-20	52	SH-P2-WH	63	SV-ROPE5-98	68	TK121-SI	67	WL170-BL	73
SFT4-6	52	SH-P3-BL	63	SV-STLT1-SI	28	TK121-WH	67	WL170-WH	73
SFT4-8	52	SH-P3-BS	63	SV-STLT1-WH	28	TK-2000-BL	66	WL2022	82
SFT4-BE20	134	SH-P3-SC	63	SV-STLT2-SI	28	TK-2000-SI	66	WL2070	82
SFT4-BE6	134	SH-P3-WH	63	SV-STLT2-WH	28	TK-2000-WH	66	WL2109-L	76
SFT4-C150	49/52	SK-B2-SC	64	SV-STLT3-SI	28	TK206-BL	67	WL2109-S	76
SFT4-C1600	49/52	SK-B3-SC	64	SV-STLT3-WH	28	TK206-SI	67	WL2198	82
SFT4-C1800	49/52	SK-P1-SC	64	SV-STLT4-SI	28	TK206-WH	67	WL2252-WH	85
SFT4-C300	49/52	SLED-C19AM	46	SV-STLT4-WH	28	TK21-BL	67	WL308-BL	127
SFT4-C600	49/52	SLED-C19BE	46	SV-SWGD-CH	25	TK21-SI	67	WL308-SG	127
SFT4-DL16	134	SLED-C19GN	46	SV-SWGD-GD	25	TK21-WH	67	WL308-WH	127
SFT4-DL20	134	SLED-C19RD	46	SV-SWGD-WH	25	TK51-BL-BL	67	WL309-BL	127
SFT4-DL6	134	SLED-C19WH	46	SV-TLTL-GD	25	TK51-SI	67	WL309-SG	127
SFT4-DL8	134	SLED-DIM	42/47	SV-TLTL-SC	25	TK51-WH-WH	67	WL309-WH	127
SFT4-GN20	134	SLED-EC15	47	SV-TLTL-WH	25	TK-CORNER-BL	66	WL3091-CH	83
SFT4-GN6	134	SLED-EC5	47	SV133-SC	30	TK-CORNER-SI	66	WL320-8	72
SFT4-PLUGS	49/52	SLED-EXT2	38	SV133-WH	30	TK-CORNER-WH	66	WL3361	85
SFT4-RD20	134	SLED-FEED	47	SVE-SDL-SS	25	TK-CROSS-BL	66	WL3371	85
SFT4-RD6	134	SLED-JOIN	47	SVE-SDL-WH	25	TK-CROSS-WH	66	WL3721	78
SFT5-13	53	SLED-R2WH	31	SVE-T50	131	TK-END-BL	66	WL4274	80
SFT5-21	53	SLED-RT2WH	31	SVE-T60	131	TK-END-SI	66	WL4337	83
SFT5-28	53	SLED-S12AM	47	SVE-T70	131	TK-END-WH	66	WL-611	82
SFT5-35	53	SLED-S12BE	47	SVE-T200	131	TK-JOIN-BL	66	WL-621	82
SFT5-BE21	134	SLED-S12GN	47	SVE-TLT-SS	25	TK-JOIN-SI	66	WL8436	80
SFT5-BLB21	134	SLED-S12RD	47	SVE90-BL	26	TK-JOIN-WH	66	WL8447	80
SFT5-C001	53	SLED-S12WH	47	SVE90-CR	26	TK-ROD-SC	66	WL8834	80
SFT5-C150	53	SLED-SQ6AM	46	SVE90-FIRE60	27	TK-TEE-BL	66	WLC2161	78
SFT5-C1800	53	SLED-SQ6BE	46	SVE90-GD	26	TK-TEE-SI	66	WLL9287-BL	79
SFT5-C300	53	SLED-SQ6GN	46	SVE90-SC	26	TK-TEE-WH	66	WLL9287-RD	79
SFT5-C600	53	SLED-SQ6RD	46	SVE90-WH	26	TKL401-BL	67	WLL9287-WH	79
SFT5-CW13	134	SLED-SQ6WH	46	SVE90S-FIRE60	27	TKL401-SI	67	WLR2161	85
SFT5-CW14	134	SLT4-300	49	SVE90S-GD	27	TKL401-WH	67	WLS2155-WH	78
SFT5-CW21	134	SLT4-600	49	SVE90S-SC	27	TKL503-BL	67	WLS9287-BL	79
SFT5-CW28	134	SLT4-900	49	SVE90S-WH	27	TKL503-SI	67	WLS9287-RD	79
SFT5-CW35	134	SLT4-1200	49	SVU-10-BS	30	TKL503-WH	67	WLS9287-WH	79
SFT5-CW8	134	SMR-5EWW	137	SVU-10-SC	30	TLED24-BL	7	WS240-BL	124
SFT5-DL13	134	SSL35-BL	125	SVU-10-WH	30	TLED24-CH	7	WS240-CH	124
SFT5-DL21	134	SSL35-WH	125	SY-B2-SG	64	TLED84-BLSI	7		
SFT5-DL28	134	SUDLED4-BL	38	SY-B2-WH	64	TLED85-WHSI	7		
SFT5-DL35	134	SUDLED4-GD	38	SY-P1-SG	64	TRIM-22-BC	75		
SFT5-GN21	134	SUDLED4-SI	38	SY-P1-WH	64	TRIM-22-BS	75		
SFT5-PLUGS	53	SUDLED4-WH	38	SY-P3-SG	64	TRIM-22-WH	75		
SFT8-BLB36	134	SUDLED4-CLIP	38	SY-P3-WH	64	TRIM-32-BC	75		
SG-B2-CH	65	SUDR-BL	38	TE1000-SI	69	TRIM-32-BS	75		
SG-P1-CH	65	SUDR-GD	38	TE100-300-SC	69	TRIM-32-WH	75		
SH-B2-BL	62	SUDR-SI	38	TE100-SC	69	TRIM-40-BC	75		
SH-B2-BS	62	SUDR-WH	38	TE101-SC	69	TRIM-40-BS	75		
SH-B2-SC	62	SV-DISK-BE	68	TE102-SC	69	TRIM-40-WH	75		
SH-B2-WH	62	SV-GMR1-SG	29	TE103-300-SC	69	TRIM90FG-SC	26		
SH-B3-BL	62	SV-GMR1-WH	29	TE103-SC	69	TRIM90FG-WH	26		
SH-B3-BS	62	SV-GMR2-SG	29	TE2000-SI	69	TRIM-C22-BC	75		
SH-B3-SC	62	SV-GMR2-WH	29	TE300-SC	69	TRIM-C22-BS	75		
SH-B3-WH	62	SV-GMR3-SG	29	TE630-SC	69	TRIM-C22-WH	75		
SH-B4-BL	62	SV-GMR3-WH	29	TE-BEND-SI	69	TRIM-C32-BC	75		
SH-B4-BS	62	SV-GMR4-SG	29	TE-CORNER-SI	69	TRIM-C32-BS	75		
SH-B4-SC	62	SV-GMR4-WH	29	TE-END-SI	69	TRIM-C32-WH	75		
SH-B4-WH	62	SV-IP55-SS	15	TE-FEED-SI	69	WBF110	117		
SH-P1-BL	63	SV-IP65-SC	15	TE-JOIN-SI	69	WBF145	117		
SH-P1-BS	63	SV-IP65-WH	15	TE-ROD-SI	69	WBP110	117		
SH-P1-SC	63	SV-PILLAR	68	TE-TEE-SI	69	WBP145	117		
SH-P1-WH	63	SV-POST	68	TK-1000-BL	66	WL1602	81		
SH-P2-BL	63	SV-ROPE3-92	68	TK-1000-SI	66	WL1606	81		
SH-P2-BS	63	SV-ROPE5-23	68	TK-1000-WH	66	WL167-SI	73		



superlux
we engineer light

Superlux Pty Ltd
33 Barry Avenue, Mortdale
NSW 2223, Australia

t: +61 2 9153 5999, f: +61 2 9153 7100
e: sales@superlux.com.au, web: www.superlux.com.au

Gartner Superlux Ltd
11 Mahunga Drive, Mangere Bridge
PO Box 13 441, Auckland 1643, New Zealand

t: +64 9 636 6092, f: +64 9 634 6802
e: sales@superlux.co.nz, web: www.superlux.co.nz