



[www.sal.net.au](http://www.sal.net.au)

# 2018-2019 PRODUCT CATALOGUE







## **SAL “L E D ing” the way toward 2018!**

SAL (Sunny Australia Lighting) will celebrate its 20th birthday in 2018. An independent, 100% Australian, family owned business founded in Western Sydney in 1998, which through the loyal support of our customers has grown to become a major force within the Australian lighting marketplace.

LED products first featured in an SAL catalogue in 2006, and 10 years later the SAL 2016 catalogue was exclusively “cover to cover” LED products, as have all subsequent SAL catalogues.

Whilst we are 100% LED, this is only the starting point when we develop new products, the factors we consider include:

- Aesthetically pleasing and Innovative design to take advantage of latest technologies
- Futureproofing by being able to utilise higher performing components as they become available
- Changes to Standards, safety requirements and legislation
- By its very nature LED products contain many more components than traditional lighting products, so to achieve the full potential performance, efficiency and lifespan it is essential to source the highest quality components across the board
- Ease of installation, environmental impact, functionality, market demands and trends

It doesn't end with product range, we understand this has to be backed up with good stockholding, and an extensive network of distributors and stockists to get the product to our end customers when they are needed, and to provide ongoing customer service.

Service is a well-worn phrase and can mean many things, at SAL service means having a knowledgeable and enthusiastic team working together to provide our customers prompt information and a quick, flexible and accurate supply of quality LED lighting products.

For details of the FULL range of SAL products and SAL Catalogues please refer to our website [www.sal.net.au](http://www.sal.net.au)



# PRODUCT CATEGORIES



LED DOWNLIGHTS



LED OYSTER & PENDANT LIGHTS

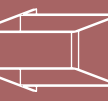

LED CABINET & WALL LIGHTS

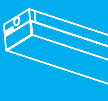

LED LINEAR & PROFILES



LED PANELS & TROFFERS

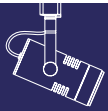

LED TRACK LIGHTS

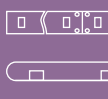

LED STRIPS



LED EXTERIOR LIGHTS



LAMPS, DRIVERS & ACCESSORIES

PIXIE

SMART LIGHTING

# PRODUCT FINDER



## LED DOWNLIGHTS

 <p>p18 S9140TC TRADER</p>	 <p>p19 S9140TC SM TRADER</p>	 <p>p20 S9141TC TRADER</p>	 <p>p21 S9041 ECOGEM</p>	 <p>p22 S9041 TC ECOGEM</p>
 <p>p23 S9041 TC S ECOGEM</p>	 <p>p24 S9041 SM ECOGEM</p>	 <p>p25 S9841 TRI-GEM</p>	 <p>p26 S9841 SM TRI-GEM</p>	 <p>p27 S9064TC, S9065TC, S9066TC WAVE</p>
 <p>p28 S9065 WAVE</p>	 <p>p29 S9865 TRI-WAVE</p>	 <p>p30 S9045 ECOSTAR</p>	 <p>p31 S9046 ECOSTAR</p>	 <p>p32 S9048 ECOSTAR</p>
 <p>p33 S9045 SM ECOSTAR</p>	 <p>p34 S9046, S9048 SM ECOSTAR</p>	 <p>p35 S9145, S9146 ECOSTAR II</p>	 <p>p36 S9053 UNIFIT</p>	 <p>p38 S9006, S9007, S9008 UNIFIT</p>
 <p>p39 S9009 UNIFIT, S9010 DECOFIT</p>	 <p>p40 LOW VOLTAGE LED DOWNLIGHT KIT (ROUND)</p>	 <p>p41 LOW VOLTAGE LED DOWNLIGHT KIT (SQUARE)</p>	 <p>p42 LED GU10 DOWNLIGHT KITS</p>	 <p>p43 S9902F-S9053 FIREFOX</p>
 <p>p44 L21022, L21021 EUROPA</p>	 <p>p45 S9514TC ALBANY</p>	 <p>p46 S9522TC, S9523TC EXMOUTH</p>	 <p>p47 S9523 SM EXMOUTH</p>	 <p>p48 S9071TC, S9072TC, S9073TC PREMIER</p>
 <p>p49 S9074TC, S9075TC, S9076TC PREMIER</p>	 <p>p50 S9656, S9658 UNI LED</p>	 <p>p51 S9656, S9658 UNI LED</p>	 <p>p52 S9520 SEYMOUR, S9530 MANSFIELD</p>	 <p>p54 S9545 NEWMAN MKII</p>



## LED OYSTER & PENDANT LIGHTS



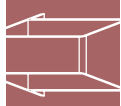

## LED CABINET & WALL LIGHTS



p100  
S9105, S9105 SR, S9105 ST  
ANOVA



p101  
S9320 CUBE



p102  
S9327, S9328 LOUNGE I & II



p103  
S9356 UD



p104  
S9311 BROOM



p105  
S9316, S9317 DARHAM



p106  
S9318 LEEMAN



p107  
S9319 LEEMAN MINI



p108  
S9511/LED, S9512/LED  
DESERT



p109  
S9515 BEACON

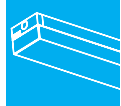

## LED LINEAR & PROFILES



p112  
SL9707 TC BLADE



p112  
SL9709 TC BLADE



p114  
SLD2000, SLD4000 LEDLINE



p116  
SL9732 ECOLINE



p118  
STB/106, STB/206, STB/112,  
STB/212 TUBELINE



p119  
STD/106, STD/206, STD/112,  
STD/212 TUBELINE



p120  
STG/106, STG/206, STG/112,  
STG/212 TUBELINE



p121  
S9733L WIDELINE



p122  
SL9706 TC SEAMLESS  
SLIMLINE



p124  
S9776 TITAN



p126  
S9775 PHOENIX



p242  
SL9721 KEW



p244  
SL9726 TC SOL

Note: For Weatherproof Battens refer to LED EXTERIOR LIGHTS section of this catalogue.



## LED PANELS & TROFFERS



p130  
S9714 PANEL



p132  
S9714HO/TC PANEL



p133  
S9714HC PANEL



p134  
S9714-AS PANEL



p135  
S9704 RECESSED  
CEILING FRAME



p136  
S9714-CR BISMARCK



p137  
S-FM SURFACE MOUNTED  
FRAME



p138  
SUSPENSION KITS



p139  
S9724 L-LINE



p140  
S9734 L-LINE MKII



p141  
S9725 ORION

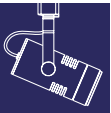

## LED TRACK LIGHTS



p144  
STR4800/1, STR4800/2  
UNIVERSAL



p146  
STR4855L, STR4856L SPOT I



p147  
STR4863GU SPOT II  
STR4863LV WH SPOT III



p148  
STR4861 SPOTTY I



p149  
STR4866 SPOCK



p150  
STR4890 UNIVERSAL



p152  
STR4881 UNIVERSAL I



p153  
STR4882 UNIVERSAL II  
STR4883 UNIVERSAL III



p154  
STR4886 SPOCK



p155  
STR3/4863GU SPOT IV



p156  
STR9017 UNITREK  
STR3/9017 UNITREK



p157  
SMT9017 UNITREK  
SRC9017 UNITREK

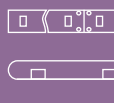

# LED STRIPS



**p162**  
FL1209/S, FL1209/SR



**p163**  
FL1206/S



**p164**  
FLP12V2M/S, FLP12V5M/S



**p165**  
FLP12V5M/RGB



**p166**  
FL2406/R05 FLEXI

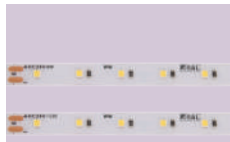

**p167**  
FL2406/SS10, FL2412/SS10  
FLEXI



**p168**  
FLH2420

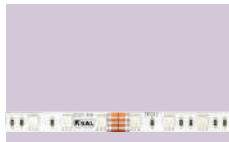

**p169**  
FL2415RGB/S



**p170**  
FLC05CS, FLC10CS



**p170**  
FLC10SS

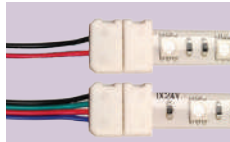

**p170**  
FLC 400 S, FLC 400 RGB



**p172**  
SLT1000



**p172**  
SLT3000

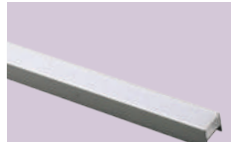

**p172**  
SLT3010



**p172**  
SLT3020



**p172**  
SLT3030



**p173**  
SLT3040



**p173**  
SLT3050



**p173**  
SLT4050



**p173**  
SLT5000



**p173**  
SLT6000



**p173**  
SLT6010

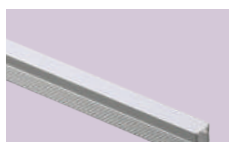

**p173**  
SLT6050



**p174**  
LT8903 DIM



**p174**  
LT8903 RGB



**p176**  
LT8904 DIM/RP



**p176**  
LT8904 RGB/RP



**p178**  
LT8905 DIM



**p178**  
LT8905 RGB





# LED EXTERIOR LIGHTS



p182  
SPK1000, SPK2000  
STARLIGHT



p183  
SPSK1000, SPSK2000 STAR-  
LIGHT WITH SENSOR



p184  
SE7080/1, SE7080/2  
STARGEM



p185  
SES7080/1, SES7080/2  
STARGEM WITH SENSOR



p186  
SE7060, SE7060  
STARGEM II



p187  
SES7090/2 BATWING



p188  
SE7071 STARPAD



p190  
SE7174 NEW STAR



p192  
SE7099 MAXISTAR



p194  
SE7199 BRIGHT STAR



p197  
SE7253, SE7254, SE7255  
C-SERIES



p198  
SE7273 LUCIA



p198  
SE7013 MOD



p199  
SL7269, SL7270 BUTTON



p200  
SL9712, SL9712/40  
VENICE



p201  
SL9719SQ MEMPHIS  
SQUARE, SL9719RD  
MEMPHIS ROUND



p202  
SE7081L, SE7082L COOPER



p201  
SE7083L, SE7084L COOPER



p204  
SE7087L REC-BUNKER



p204  
SE7089 BRONX



p205  
SE7073 FLEX



p206  
SL7262, SL7267 NEWPORT



p207  
SL7263, SL7268 NEWPORT



p208  
SE7135 MAXI LOUVERED  
SE7136 MAXI SLOT  
SE7137 MAXI EYELID



p209  
SE7138 MAXI GRILLED  
SE7139 MAXI PLAIN



p210  
SE7140 LOUVERED  
SE7141 SLOT  
SE7142 PLAIN



p212  
SE7121, SE7122,  
SE7123 BONDI



p213  
SE7133, SE7134 ETON



p214  
SE7131, SE7132  
NEW FLINDERS WALL



p215  
SL7221, SL7222 NEW BONDI



p215  
SE7062 LACHLAN WALL



p216  
SL7223, SL7224  
NEW BONDI II



p217  
SE7145 SCOOP



p218  
SE7146 QUARTER



p219  
SE7147 MINI STEIN





# LAMPS, DRIVERS & ACCESSORIES

 p258 LG5, LG9 CLEAR	 p259 LG5, LG9 OPAL	 p260 LCA CLEAR	 p261 LCA OPAL	 p262 LFR CLEAR
 p263 LFR OPAL	 p264 LT25 CLEAR LED FILAMENT PILOT LAMP	 p265 LST21FD, LG125FD	 p266 LG95, LG125	 p267 LG95, LG125 OPAL
 p268 LGS4, LGS8, LGS10 OPAL	 p269 LGS14D OPAL	 p270 LT407	 p271 LT409, LT409D	 p272 LT8
 p273 AR111 LAMP	 p273 AR111 MODULE	 p274 MR16 5W, MR16 7W, MR16 DIM9W	 p275 GU10L350, GU10L550, GU10LA750, GU10LR750	 p276 LR50, LR63, LR80, LR95
 p277 LPAR20, LPAR30, LPAR38	 p278 G4L15, G4L25	 p279 G9L	 p279 GX53	 p280 SLC21, SLC30
 p281 LCT21TC, LCT30TC	 p282 PLUTO, PLUTO EGL	 p283 DIM100W, DIM200W, DIM110/150W, DIM40W/12V	 p284 PLUTO 350MA, 500MA, 700MA, 1400MA	 p285 MINI60
 p286 ST105, ST150, ST200, ST300, ST400	 p286 SELK2500/SM TRIANGLE	 p287 SELK1500ISF S-FIRE	 p288 SDD350TCM, SDD350TCS TRAILING EDGE DIMMER	 p288 SDA450, SDF30





p304  
SDD350BT



p305  
SWL350BT



p306  
FLP12V/SBT FLEXI SMART



p307  
FLP12V/RGBBT FLEXI  
SMART



### Device

Manage devices,  
individual control



### Group

Simultaneous  
control by groups



### Schedule

Schedule your lights



### Scene

Create preset  
lighting scenes



### Timer

Countdown  
turn-off timer



### Sync

PIXIE RGB strip  
flash to music beat

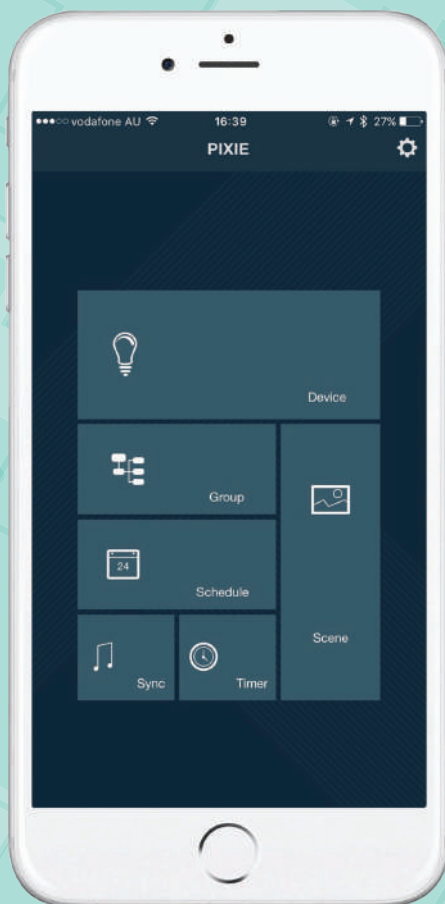



[www.sal.net.au](http://www.sal.net.au)

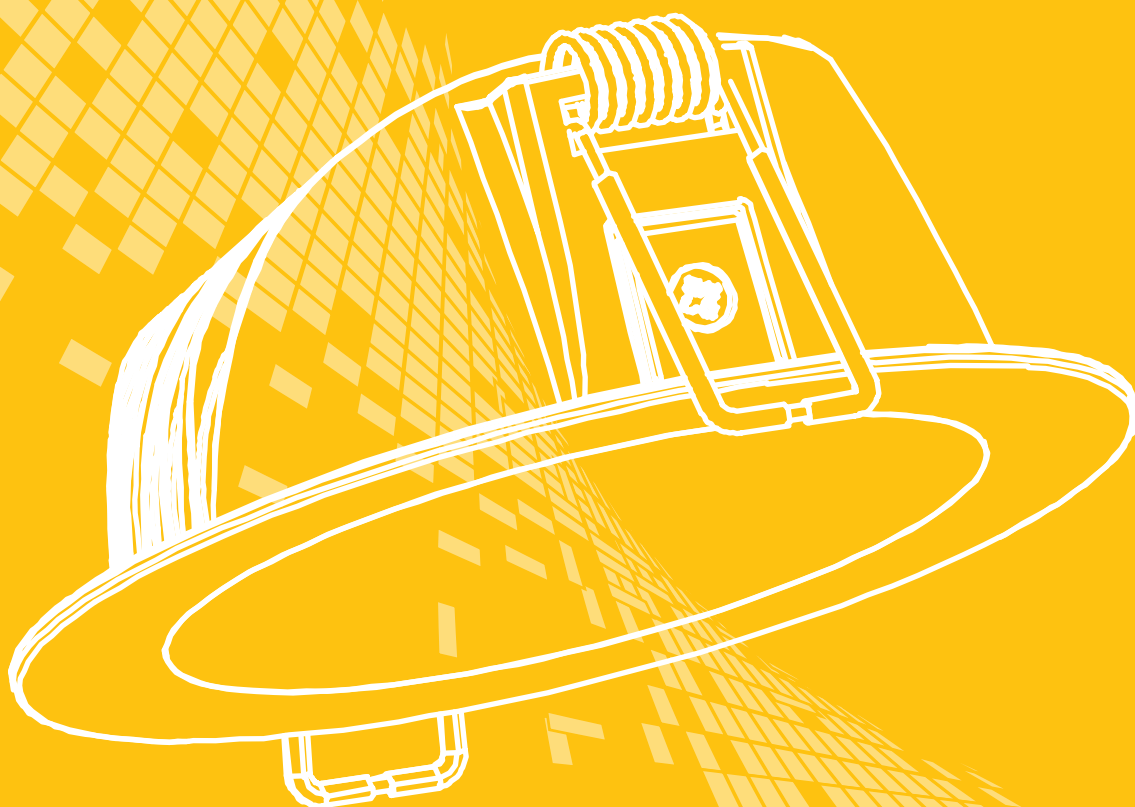



# LED DOWNLIGHTS

## NEW PRODUCTS



# DIMMABLE LED DOWNLIGHT

## S9140TC TRADER



### CONSTRUCTION

- Select colour temperature with DIP switch
- Die-cast aluminium body
- Powder coated finish
- Opal acrylic diffuser
- High efficiency SMD LED chips
- Constant current trailing edge dimmable LED driver fitted
- 1.2 m flex & 2 pin plug fitted

### IP RATING

- IP44 weatherproof front only

### DIMMING OPTIONS

- 1-10V analogue
- DALI / DSI, digital

### FITTING COLOUR OPTION

- Satin Nickel (S9140SN/RING)



### DIMENSIONS

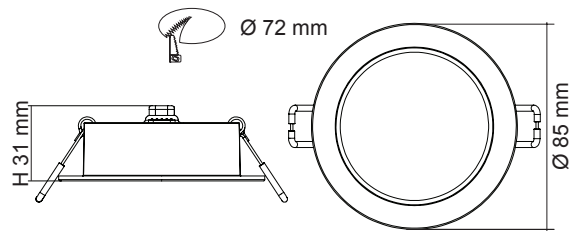

Model No.	Input	Power	Lumen	CCT	Beam Angle	CRI	Dimmable	Fitting Colour
S9140TC/WH	240V	8W	650lm/700lm/700lm	3000K/4000K/5700K	90°	>80	Yes*	White

\*Trailing edge dimming

### PHOTOMETRIC DATA

Unit: cd C0/C180 — C90/C270

S9140TC at 3000K

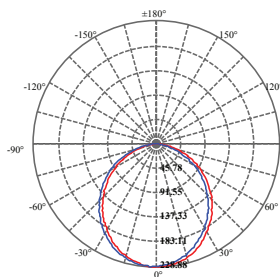

S9140TC at 4000K

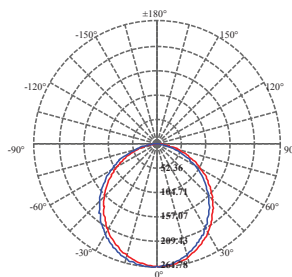

S9140TC at 5700K

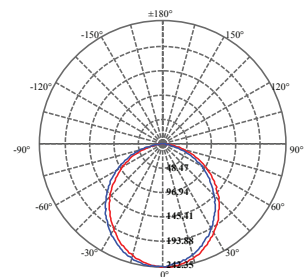



# SURFACE MOUNTED DIMMABLE LED DOWNLIGHT

## S9140TC SM TRADER



### CONSTRUCTION

- Extruded aluminium surface mount casing
- Powder coated finish
- S9140TC LED downlight kit included
- Built-in constant current trailing edge dimmable LED driver

### IP RATING

- IP20 suitable for interior use only



### DIMENSIONS

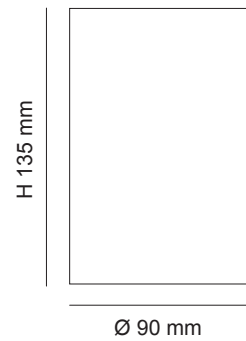

Model No.	Input	Power	Lumen	CCT	Beam Angle	CRI	Dimmable	Fitting Colour
S9140SM/C TC WH	240V	8W	650lm/700lm/700lm	3000K/4000K/5700K	90°	>80	Yes*	White

\*Trailing edge dimming

### PHOTOMETRIC DATA

Unit: cd C0/C180 — C90/C270

S9140TC at 3000K

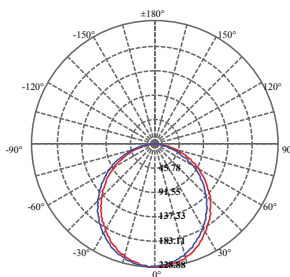

S9140TC at 4000K

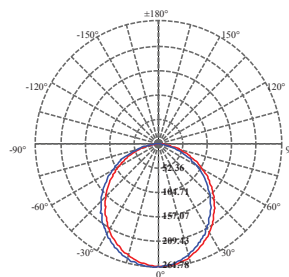

S9140TC at 5700K

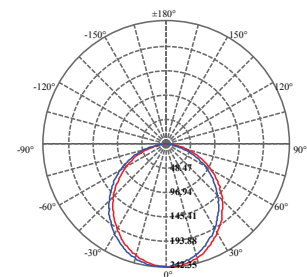

# DIMMABLE LED DOWNLIGHT

## S9141TC TRADER



### CONSTRUCTION

- Select colour temperature with DIP switch
- Die-cast aluminium body
- Powder coated finish
- Opal acrylic diffuser
- High efficiency SMD LED chips
- Constant current trailing edge dimmable LED driver fitted
- 1.2 m flex & 2 pin plug fitted

### IP RATING

- IP44 weatherproof front only

### DIMMING OPTIONS

- 1-10V analogue
- DALI / DSI, digital

### FITTING COLOUR OPTION

- Satin Nickel (S9141SN/RING)

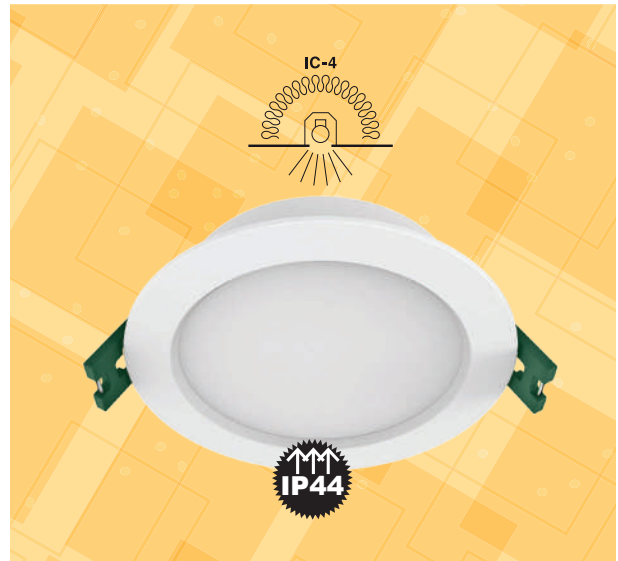

### DIMENSIONS

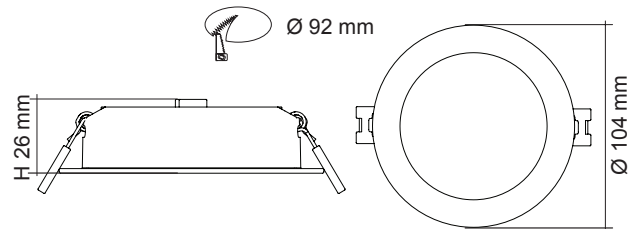

Model No.	Input	Power	Lumen	CCT	Beam Angle	CRI	Dimmable	Fitting Colour
S9141TC/WH	240V	9W	700lm/850lm/800lm	3000K/4000K/5700K	110°	>80	Yes*	White

S9141TC/WH/K12 Includes 12 x S9141TC/WH

\*Trailing edge dimming

### PHOTOMETRIC DATA Unit: cd C0/C180 — C90/C270

S9141TC at 3000K

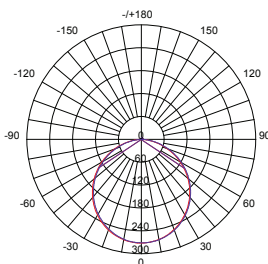

S9141TC at 4000K

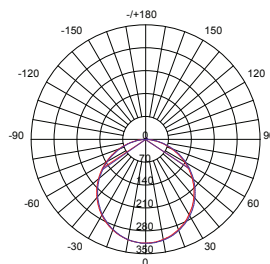

S9041TC at 5700K

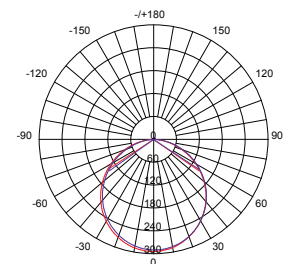

# DIMMABLE LED DOWNLIGHT

## S9041 ECOGEM



### CONSTRUCTION

- Die-cast aluminium body
- Powder coated finish
- Opal acrylic diffuser
- High efficiency SMD LED chips
- Constant current trailing edge dimmable LED driver fitted
- 1.2 m flex & 2 pin plug fitted

### IP RATING

- IP44 weatherproof front only

### DIMMING OPTIONS

- 1-10V analogue
- DALI / DSI, digital

### FITTING COLOUR OPTION

- Black (**S9041 BK RING**)
- Satin Nickel (**S9041 SN RING**)
- Silver (**S9041 SL RING**)

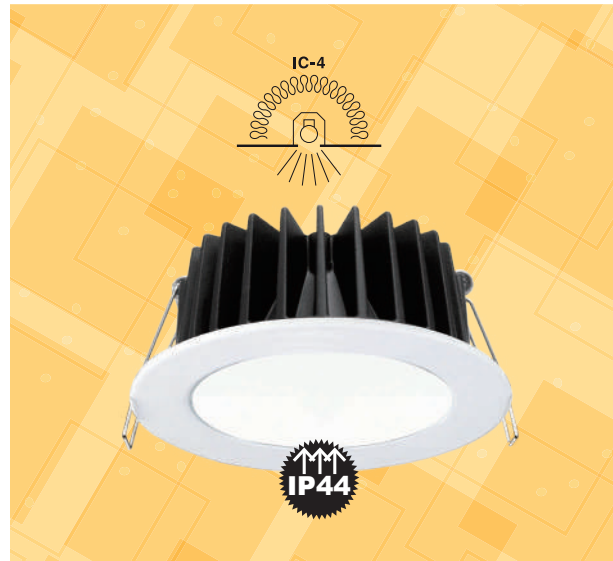

### DIMENSIONS

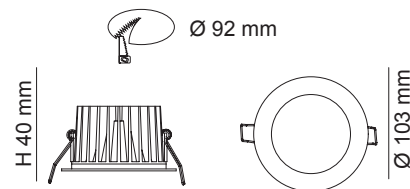

Model No.	Input	Power	Lumen	CCT	Beam Angle	CRI	Dimmable	Fitting Colour
S9041 WW WH	240V	10W	700lm	3000K	90°	>80	Yes*	White
S9041 CW WH	240V	10W	780lm	4000K	90°	>80	Yes*	White
S9041 DL WH	240V	10W	800lm	6000K	90°	>80	Yes*	White

\*Trailing edge dimming

### PHOTOMETRIC DATA Unit: cd C0/C180 — C90/C270

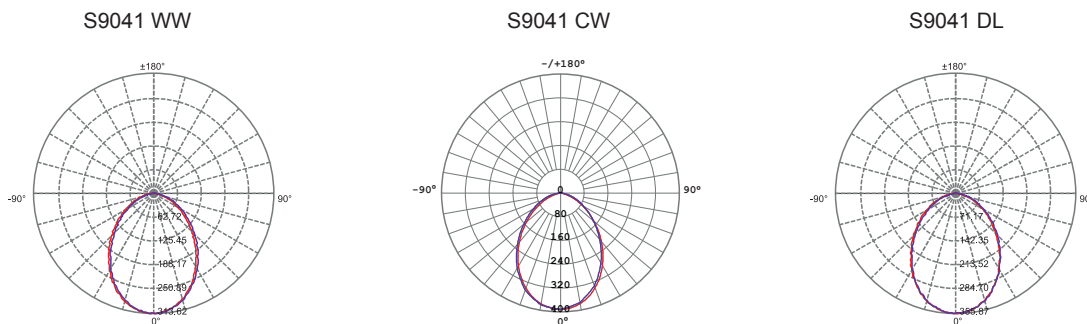

Dimmer/Switch  
Compatible



www.sal.net.au

# DIMMABLE LED DOWNLIGHT

## S9041 TC ECOGEM



### CONSTRUCTION

- Select colour temperature with DIP switch
- Die-cast aluminium body
- Powder coated finish
- Opal acrylic diffuser
- High efficiency SMD LED chips
- Constant current trailing edge dimmable LED driver fitted
- 1.2 m flex & 2 pin plug fitted

### IP RATING

- IP44 weatherproof front only

### DIMMING OPTIONS

- 1-10V analogue
- DALI / DSI, digital

### FITTING COLOUR OPTION

- Black (**S9041 BK RING**)
- Satin Nickel (**S9041 SN RING**)
- Silver (**S9041 SL RING**)



### DIMENSIONS

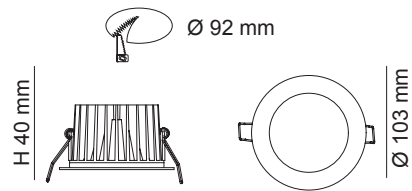

Model No.	Input	Power	Lumen	CCT	Beam Angle	CRI	Dimmable	Fitting Colour
S9041 TC WH	240V	10W	800lm/900lm/850lm	3000K/4200K/5700K	90°	>80	Yes*	White

\*Trailing edge dimming

### PHOTOMETRIC DATA Unit: cd C0/C180 — C90/C270

S9041 TC at 3000K

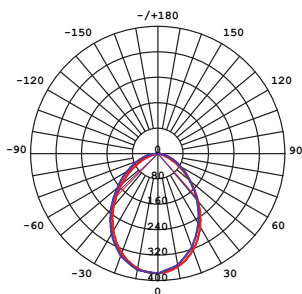

S9041 TC at 4000K

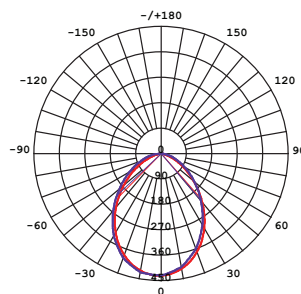

S9041 TC at 5700K

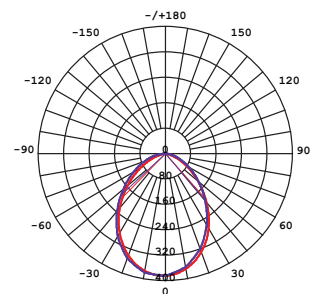

# DIMMABLE LED SQUARE DOWNLIGHT

## S9041 TC S ECOGEM



### CONSTRUCTION

- Select colour temperature with DIP switch
- Die-cast aluminium body
- Powder coated or plated finish
- Opal acrylic diffuser
- High efficiency SMD LED chips
- Constant current trailing edge dimmable LED driver fitted
- 1.2 m flex & 2 pin plug fitted

### IP RATING

- IP44 weatherproof front only

### DIMMING OPTIONS

- 1-10V analogue
- DALI / DSI, digital



### DIMENSIONS

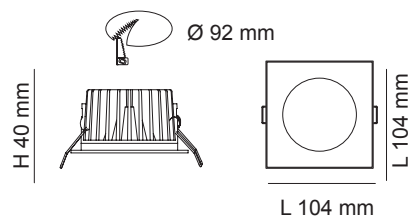

Model No.	Input	Power	Lumen	CCT	Beam Angle	CRI	Dimmable	Fitting Colour
S9041 TC S WH	240V	10W	800/900/850lm	3000/4200K/5700K	90°	>80	Yes*	White
S9041 TC S SN	240V	10W	800/900/850lm	3000/4200K/5700K	90°	>80	Yes*	Satin Nickel

\*Trailing edge dimming

### PHOTOMETRIC DATA Unit: cd C0/C180 — C90/C270

S9041 TC S at 3000K

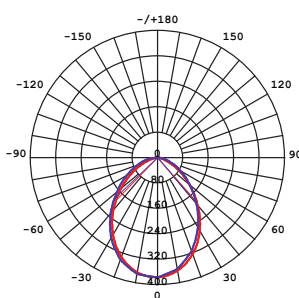

S9041 TC S at 4000K

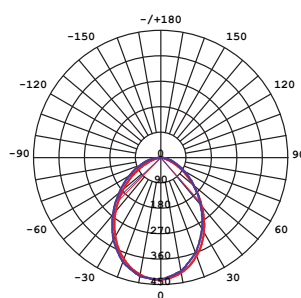

S9041 TC S at 5700K

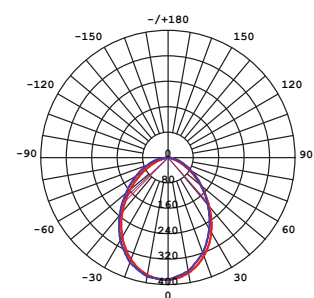

# SURFACE MOUNTED DIMMABLE LED DOWNLIGHT

## S9041 SM ECOGEM



### CONSTRUCTION

- Pressed metal surface mount casing
- Powder coated finish
- S9041 LED downlight kit included
- Constant current trailing edge dimmable LED driver fitted

### IP RATING

- IP20 suitable for interior use only

### DIMMING OPTIONS

- 1-10V analogue
- DALI / DSI, digital



### DIMENSIONS

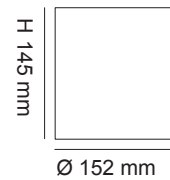

Model No.	Input	Power	Lumen	CCT	Beam Angle	CRI	Dimmable	Fitting Colour
S9041SM/C WW WH	240V	10W	700lm	3000K	90°	>80	Yes*	White
S9041SM/C CW WH	240V	10W	780lm	4000K	90°	>80	Yes*	White
S9041SM/C DL WH	240V	10W	800lm	6000K	90°	>80	Yes*	White
S9041SM/C TC WH	240V	10W	800lm/900lm/850lm	3000K/4200K/5700K	90°	>80	Yes*	White

\*Trailing edge dimming

### PHOTOMETRIC DATA Unit: cd C0/C180 — C90/C270

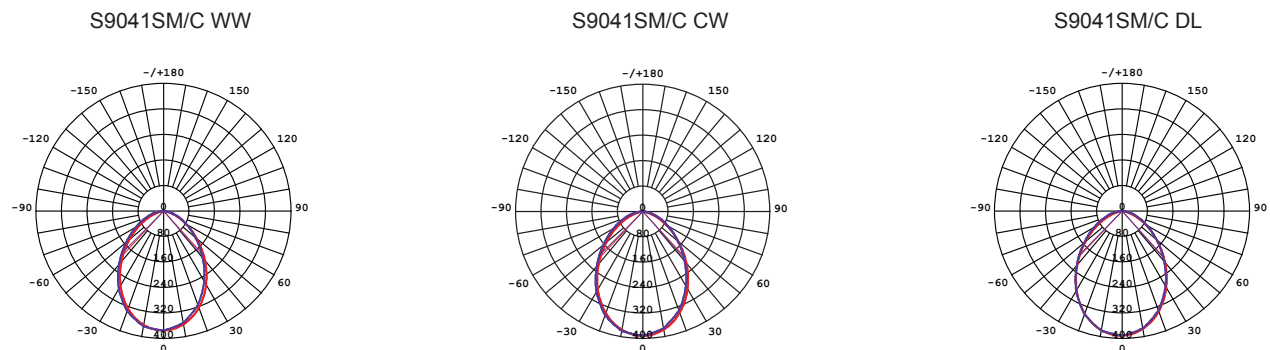



# DIMMABLE LED DOWNLIGHT

## COLOUR TEMPERATURE CHANGEABLE

### S9841 TRI-GEM



#### CONSTRUCTION

- Die-cast aluminium body
- Powder coated finish
- Opal acrylic diffuser
- High efficiency SMD LED chips
- Constant current trailing edge dimmable LED driver fitted
- 1.2 m flex & 2 pin plug fitted

#### IP RATING

- IP44 weatherproof front only

#### COLOUR TEMPERATURE CHANGEABLE

- 3000K
- 4000K
- 5700K

#### FITTING COLOUR OPTION

- Black (S9041 BK RING)
- Satin Nickel (S9041 SN RING)
- Silver (S9041 SL RING)



#### DIMENSIONS

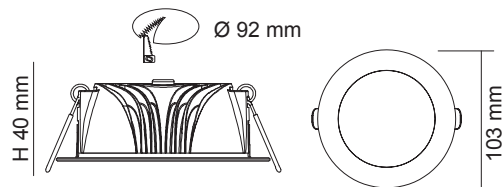

Model No.	Input	Power	Lumen	CCT	Beam Angle	CRI	Dimmable	Fitting Colour
S9841WH	240V	10W	750lm/800lm/800lm	3000K/4000K/5700K	90°	>80	Yes*	White

S9841WH/K4/1 Includes 4 x S9841WH plus 1 x SDD350TCM

\*Trailing edge dimming

#### 3 COLOUR TEMPERATURE CHANGEABLE WITH

- Switch: off/on twice or
- Recommended dimmers: SDD350TCM (double click), SDD350BT (triple click)

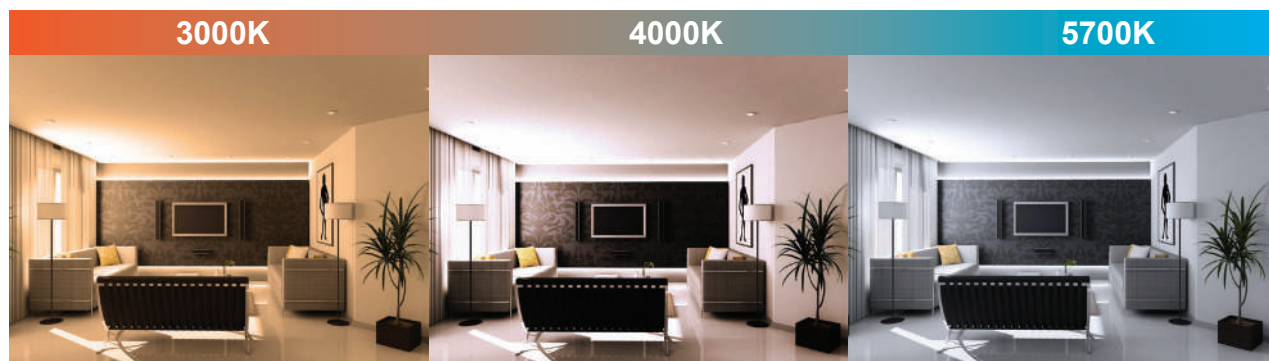

# SURFACE MOUNTED DIMMABLE LED DOWNLIGHT COLOUR TEMPERATURE CHANGEABLE

## S9841 SM TRI-GEM



### CONSTRUCTION

- Pressed metal surface mount casing
- Powder coated finish
- S9841 LED downlight kit included
- Constant current trailing edge dimmable LED driver fitted

### IP RATING

- IP20 suitable for interior use only

### COLOUR TEMPERATURE CHANGEABLE

- 3000K
- 4000K
- 5700K



### DIMENSIONS

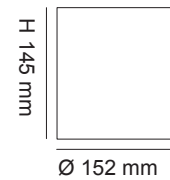

Model No.	Input	Power	Lumen	CCT	Beam Angle	CRI	Dimmable	Fitting Colour
S9841SM/C WH	240V	10W	750lm/800lm/800lm	3000K/4000K/5700K	90°	>80	Yes*	White

\*Trailing edge dimming

### 3 COLOUR TEMPERATURE CHANGEABLE WITH

- Switch: off/on twice or
- Recommended dimmers: SDD350TCM (double click), SDD350BT (triple click)

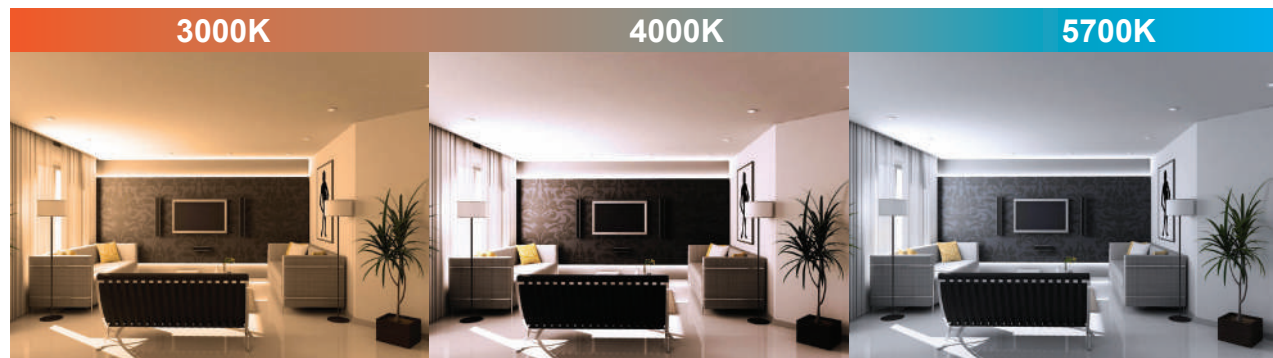



# DIMMABLE LED DOWNLIGHT

## S9064TC, S9065TC, S9066TC WAVE



### DIMENSIONS

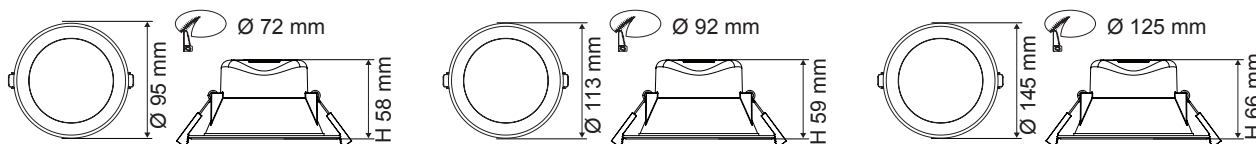

### CONSTRUCTION

- Select colour temperature with DIP switch
- Poly covered aluminium body
- Opal acrylic diffuser
- Double insulation
- High efficiency SMD LED chips
- Built-in constant current trailing edge dimmable LED driver
- 1.2 m flex & 2 pin plug fitted
- Integrated design, easy installation

### IP RATING

- IP44 weatherproof front only

### FITTING COLOUR OPTION

- Satin Nickel (S9064SN/RING, S9065SN/RING, S9066SN/RING)



Model No.	Input	Power	Lumen	CCT	Beam Angle	CRI	Dimmable	Fitting Colour
S9064TC WH	240V	7W	550lm/600lm/600lm	3000K/4000K/5700K	90°	>80	Yes*	White
S9065TC WH	240V	9W	750lm/850lm/850lm	3000K/4000K/5700K	90°	>80	Yes*	White
S9066TC WH	240V	12W	1200lm/1350lm/1350lm	3000K/4000K/5700K	90°	>80	Yes*	White

\*Trailing edge dimming

# DIMMABLE LED DOWNLIGHT

## S9065 WAVE



### CONSTRUCTION

- Poly covered aluminium body
- Opal acrylic diffuser
- Double insulation
- High efficiency SMD LED chips
- Built-in constant current trailing edge dimmable LED driver
- 1.2 m flex & 2 pin plug fitted
- Integrated design, easy installation

### IP RATING

- IP44 weatherproof front only

### FITTING COLOUR OPTION

- Satin Nickel (S9065SN/RING)



### DIMENSIONS

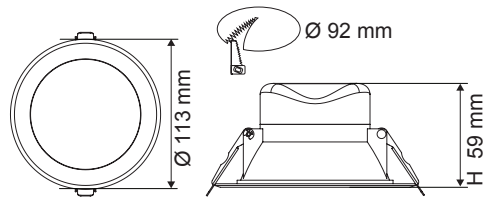

Model No.	Input	Power	Lumen	CCT	Beam Angle	CRI	Dimmable	Fitting Colour
S9065WW WH	240V	9W	750lm	3000K	90°	>80	Yes*	White
S9065CW WH	240V	9W	850lm	4000K	90°	>80	Yes*	White
S9065DL WH	240V	9W	850lm	6000K	90°	>80	Yes*	White

\*Trailing edge dimming

### PHOTOMETRIC DATA Unit: cd C0/C180 — C90/C270

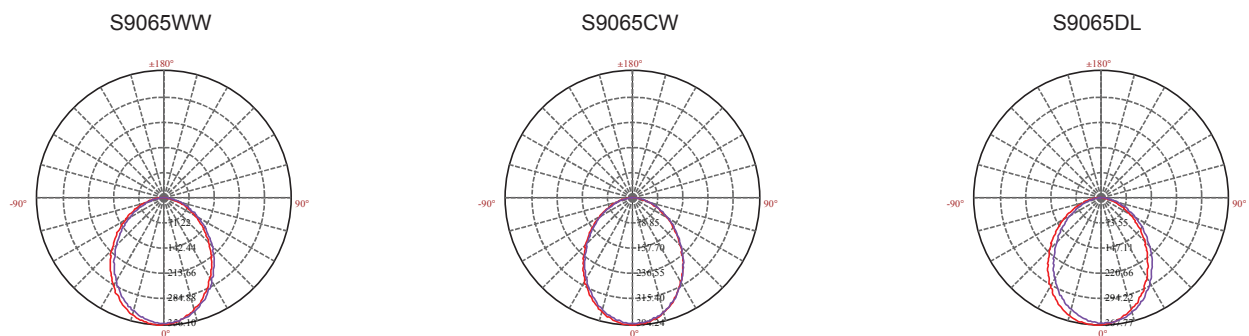

# DIMMABLE LED DOWNLIGHT COLOUR TEMPERATURE CHANGEABLE S9865 TRI-WAVE



## CONSTRUCTION

- Poly coated aluminium body
- Opal acrylic diffuser
- Double insulation 
- High efficiency SMD LED chips
- Built-in constant current trailing edge dimmable LED driver
- 1.2 m flex & 2 pin plug fitted
- Integrated design, easy installation

## IP RATING

- IP44 weatherproof front only

## FITTING COLOUR OPTION

- Satin Nickel (S9065SN/RING)



## DIMENSIONS

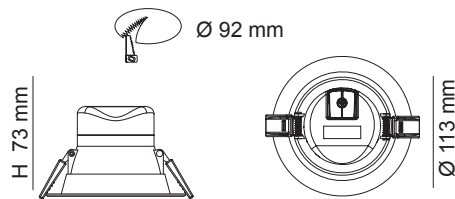

Model No.	Input	Power	Lumen	CCT	Beam Angle	CRI	Dimmable	Fitting Colour
S9865WH	240V	10W	600lm - 850lm	2700K - 5000K	90°	>80	Yes*	White

\*Trailing edge dimming

**WITHOUT DIMMER:** The default colour temperature is 5000K and lumen output is 850lm.

**WITH A STANDARD ROTARY TRAILING EDGE DIMMER FROM MAX. TO MIDWAY OF DIMMER POSITION:** The primary effect is a reduction in the colour temperature from 5000K (daylight) to 3500K (warm white), with minimal reduction in light output (from 850lm to 600lm).

**FROM MIDWAY TO MINIMUM OF DIMMER POSITION:** The primary effect is a reduction in light output (from 600lm to 100lm) with slight further warming of the colour temperature to 2700K.

## COLOUR TEMPERATURE CHANGEABLE BETWEEN 5000K TO 2700K

5000K ..... TO ..... 2700K

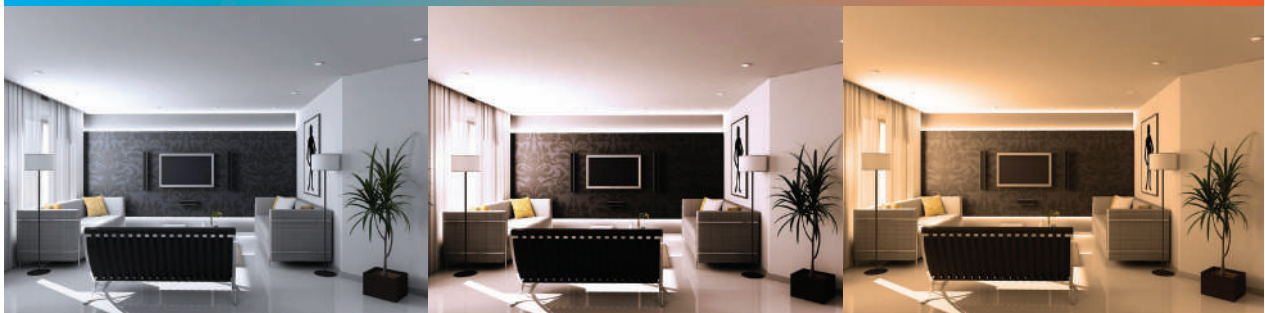

# DIMMABLE LED DOWNLIGHT

## S9045 ECOSTAR



### CONSTRUCTION

- Die-cast aluminium body
- Powder coated or plated finish
- High output COB LED chip
- Changeable multi-reflector system
- Constant current trailing edge dimmable LED driver fitted
- 1.2 m flex & 2 pin plug fitted

### IP RATING

- IP20 suitable for interior use only

### DIMMING OPTIONS

- 1-10V analogue
- DALI / DSI, digital

### BEAM ANGLE

- 60° (standard)
- 40° (option)



### DIMENSIONS

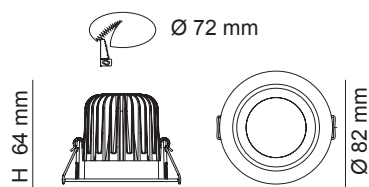

Model No.	Input	Power	Lumen	CCT	Beam Angle	CRI	Dimmable	Fitting Colour
S9045 WW WH	240V	9W	700lm	3000K	60°	>82	Yes*	White
S9045 DL WH	240V	9W	800lm	6000K	60°	>80	Yes*	White
S9045 WW SN	240V	9W	700lm	3000K	60°	>82	Yes*	Satin Nickel
S9045 DL SN	240V	9W	800lm	6000K	60°	>80	Yes*	Satin Nickel

\*Trailing edge dimming

### PHOTOMETRIC DATA Unit: cd C0/C180 \_\_\_\_\_ C90/C270 \_\_\_\_\_

S9045 WW

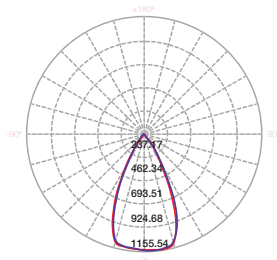

S9045 DL

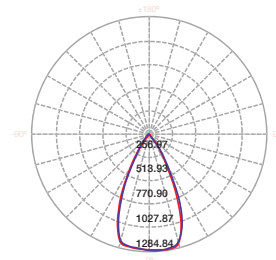

# DIMMABLE LED DOWNLIGHT

## S9046 ECOSTAR



### CONSTRUCTION

- Die-cast aluminium body
- Powder coated or plated finish
- Gimble head
- High output COB LED chip
- Changeable multi-reflector system
- Constant current trailing edge dimmable LED driver fitted
- 1.2 m flex & 2 pin plug fitted

### IP RATING

- IP20 suitable for interior use only

### DIMMING OPTIONS

- 1-10V analogue
- DALI / DSI, digital

### BEAM ANGLE

- 60° (standard)
- 40° (option)

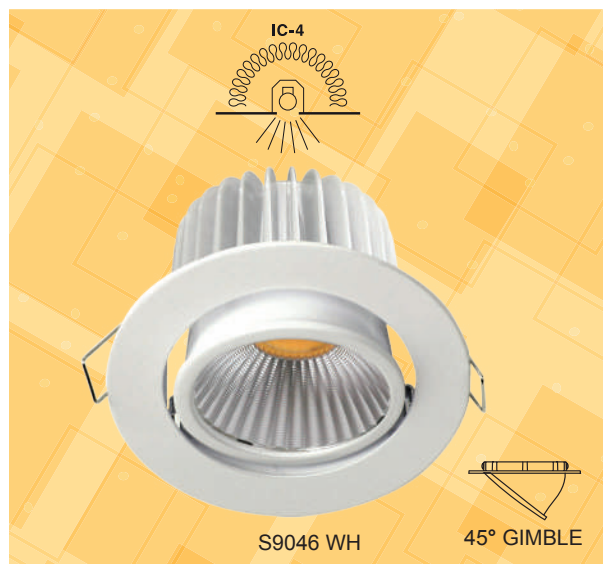

### DIMENSIONS

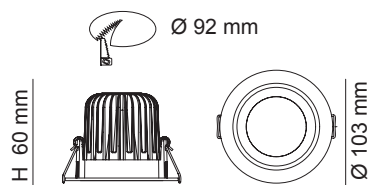

Model No.	Input	Power	Lumen	CCT	Beam Angle	CRI	Dimmable	Fitting Colour
S9046 WW WH	240V	9W	800lm	3000K	60°	>82	Yes*	White
S9046 DL WH	240V	9W	850lm	6000K	60°	>80	Yes*	White
S9046 WW SN	240V	9W	800lm	3000K	60°	>82	Yes*	Satin Nickel
S9046 DL SN	240V	9W	850lm	6000K	60°	>80	Yes*	Satin Nickel

\*Trailing edge dimming

### PHOTOMETRIC DATA

Unit: cd C0/C180 \_\_\_\_\_ C90/C270 \_\_\_\_\_

S9046 WW

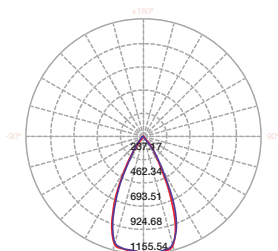

S9046 DL

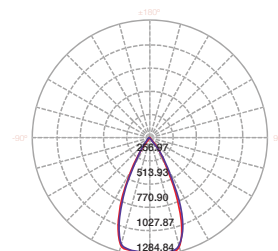



# DIMMABLE LED DOWNLIGHT

## S9048 ECOSTAR



### CONSTRUCTION

- Die-cast aluminium body
- Powder coated or plated finish
- High output COB LED chip
- Multi-reflector system
- Built-in constant current trailing edge dimmable LED driver
- 1.2 m flex & 2 pin plug fitted

### IP RATING

- IP44 weatherproof front only

### FITTING COLOUR OPTION

- Black (**S9041 BK RING**)
- Satin Nickel (**S9041 SN RING**)
- Silver (**S9041 SL RING**)



### DIMENSIONS

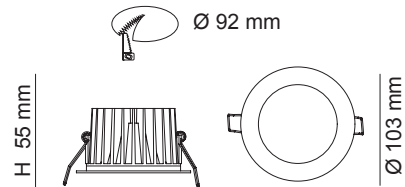

Model No.	Input	Power	Lumen	CCT	Beam Angle	CRI	Dimmable	Fitting Colour
S9048 WW WH	240V	12W	750lm	3000K	55°	>80	Yes*	White
S9048 DL WH	240V	12W	800lm	5000K	55°	>80	Yes*	White
S9048 WW SN	240V	12W	750lm	3000K	55°	>80	Yes*	Satin Nickel
S9048 DL SN	240V	12W	800lm	5000K	55°	>80	Yes*	Satin Nickel

\*Trailing edge dimming

### PHOTOMETRIC DATA Unit: cd C0/C180 — C90/C270

S9048 WW

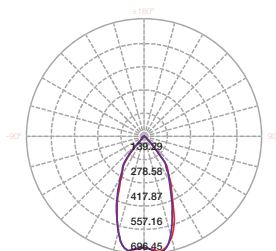

S9048 DL

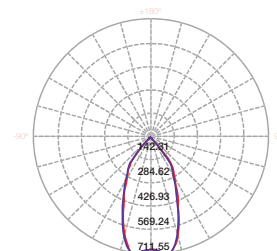

# SURFACE MOUNTED DIMMABLE LED DOWNLIGHT

## S9045 SM ECOSTAR



### CONSTRUCTION

- Extruded aluminium surface mount casing
- Powder coated finish
- S9045 LED downlight kit included
- Changeable multi-reflector system
- Constant current trailing edge dimmable LED driver fitted

### IP RATING

- IP20 suitable for interior use only

### BEAM ANGLE

- 60° (standard)
- 40° (option)



### DIMENSIONS

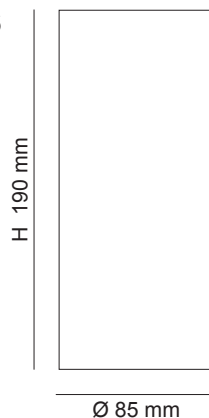

Model No.	Input	Power	Lumen	CCT	Beam Angle	CRI	Dimmable	Fitting Colour
S9045SM/C WW WH	240V	9W	700lm	3000K	60°	>80	Yes*	White
S9045SM/C DL WH	240V	9W	800lm	6000K	60°	>80	Yes*	White

\*Trailing edge dimming

### PHOTOMETRIC DATA Unit: cd C0/C180 ——— C90/C270 ———

S9045 WW

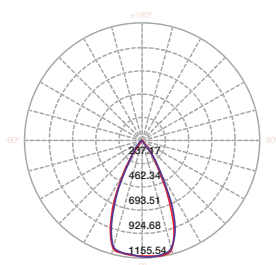

S9045 DL

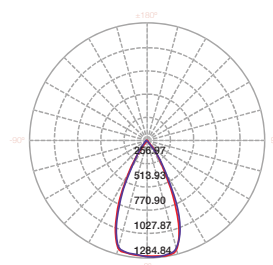

# SURFACE MOUNTED DIMMABLE LED DOWNLIGHT

## S9046, S9048 SM ECOSTAR



### CONSTRUCTION

- Pressed metal surface mount casing
- Powder coated finish
- S9046 or S9048 LED downlight kits included
- Built-in constant current trailing edge dimmable LED driver

### IP RATING

- IP20 suitable for interior use only

### DIMMING OPTIONS (S9046SM/C)

- 1-10V analogue
- DALI / DSI, digital

### BEAM ANGLE OPTIONS (S9046SM/C)

- 40° beam angle reflector

### DIMENSIONS

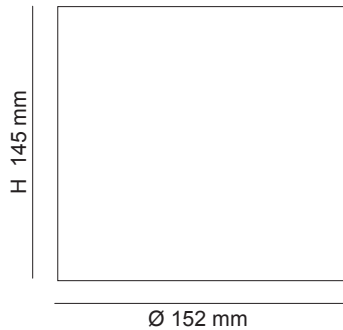

Model No.	Input	Power	Lumen	CCT	Beam Angle	CRI	Dimmable	Fitting Colour
S9046SM/C WW WH	240V	9W	800lm	3000K	60°	>82	Yes*	White
S9046SM/C DL WH	240V	9W	850lm	6000K	60°	>80	Yes*	White

\*Trailing edge dimming

Model No.	Input	Power	Lumen	CCT	Beam Angle	CRI	Dimmable	Fitting Colour
S9048SM/C WW WH	240V	12W	750lm	3000K	55°	>80	Yes*	White
S9048SM/C DL WH	240V	12W	800lm	5000K	55°	>80	Yes*	White

\*Trailing edge dimming

### PHOTOMETRIC DATA

Please refer to S9046, S9048



# DIMMABLE LED DOWNLIGHT

## S9145, S9146 ECOSTAR II

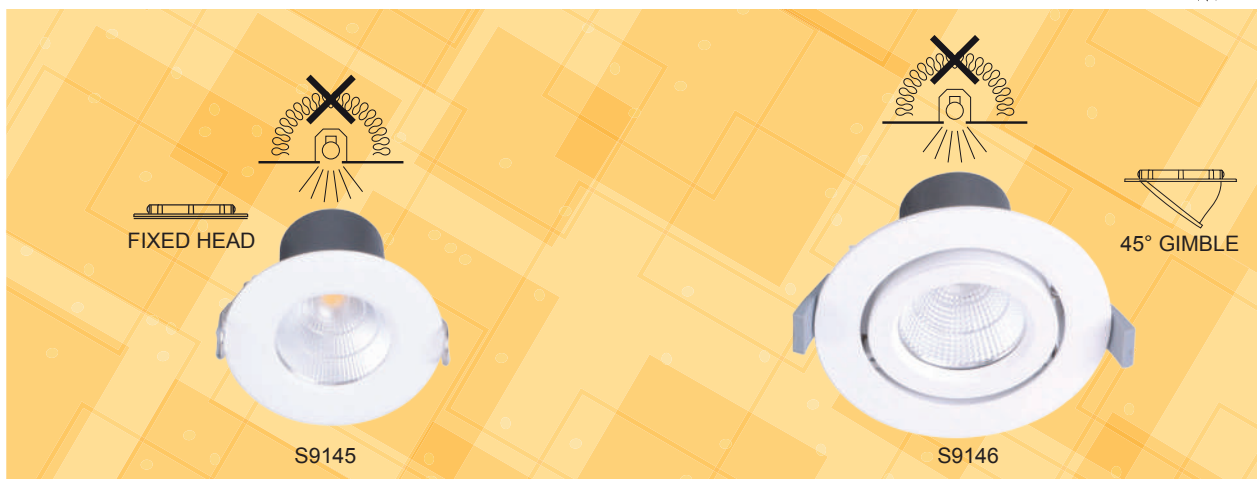

### DIMENSIONS

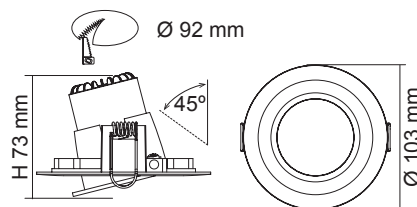
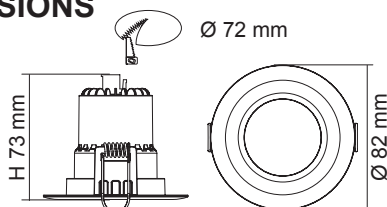

### CONSTRUCTION

- Die-cast aluminium body
- Powder coated finish
- High output COB LED chip
- Changeable multi-reflector system
- Polycarbonate optical lens
- Constant current trailing edge dimmable LED driver fitted
- 1.2 m flex & 2 pin plug fitted

### IP RATING

- IP20 suitable for interior use only

### DIMMING OPTIONS

- 1-10V analogue
- DALI / DSI, digital

### BEAM ANGLE

- 60° (standard)
- 25° reflector (option)
- 40° reflector (option)

Model No.	Input	Power	Lumen	CCT	Beam Angle	CRI	Dimmable	Fitting Colour
S9145WW/WH	240V	9W	700lm	3000K	60°	>80	Yes*	White
S9145CW/WH	240V	9W	800lm	4000K	60°	>80	Yes*	White
S9145DL/WH	240V	9W	800lm	6000K	60°	>80	Yes*	White
S9146WW/WH	240V	9W	700lm	3000K	60°	>80	Yes*	White
S9146CW/WH	240V	9W	800lm	4000K	60°	>80	Yes*	White
S9146DL/WH	240V	9W	800lm	6000K	60°	>80	Yes*	White

\*Trailing edge dimming

### PHOTOMETRIC DATA Unit: cd C0/C180 — C90/C270

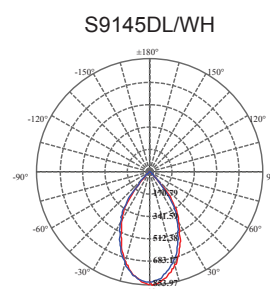
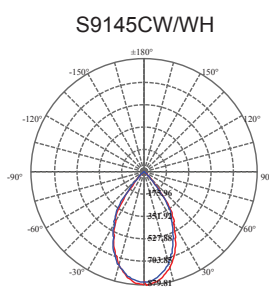
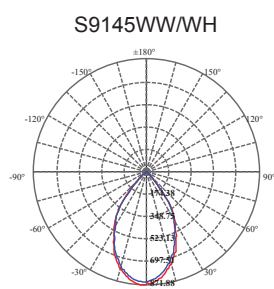

Specifications above are for reference only and may vary without prior notice



Dimmer/Switch Compatible



www.sal.net.au

# DIMMABLE LED MODULE

## S9053 UNIFIT



### CONSTRUCTION

- Die-cast aluminium heat sink
- High output COB LED chip
- Changeable multi-reflector system
- Polycarbonate optical lens
- Constant current trailing edge dimmable LED driver fitted
- 1.2 m flex & 2 pin plug fitted

### IP RATING

- IP20 suitable for interior use only

### ACCESSORIES

- **S9053HC/P** Honey comb
- **S9053DF/P** Centre frost diffuser
- **S9053BF/P** Buffer

### DIMMING OPTIONS

- 1-10V analogue
- DALI / DSI, digital

### BEAM ANGLE

- 60° (standard)
- 25° reflector (option)
- 40° reflector (option)



### DIMENSIONS

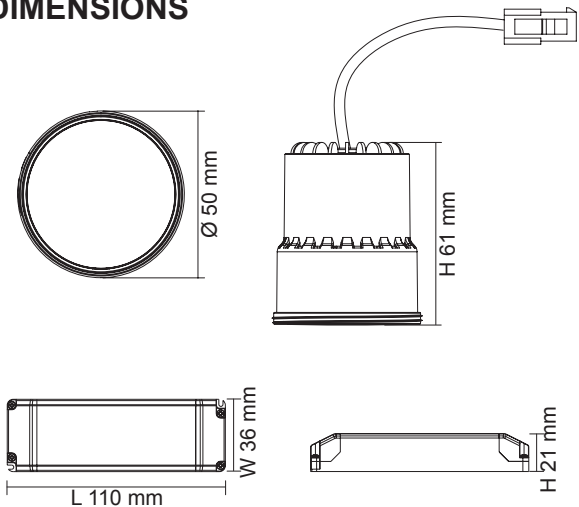

Model No.	Input	Power	Lumen	CCT	Beam Angle	CRI	Dimmable
S9053 WP	240V	9W	700lm	3000K	60°	>80	Yes*
S9053 CP	240V	9W	800lm	4000K	60°	>80	Yes*
S9053 DP	240V	9W	800lm	6000K	60°	>80	Yes*

\*Trailing edge dimming

### PHOTOMETRIC DATA Unit: cd C0/C180 — C90/C270

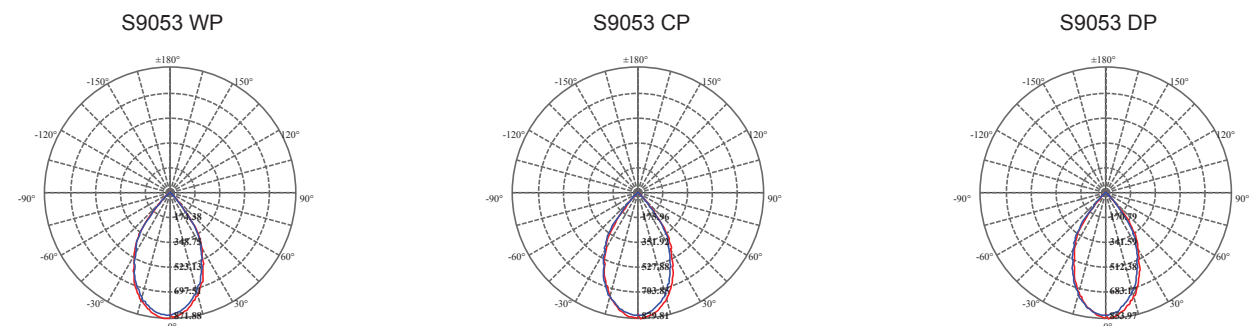

## DEDICATED HEADS



## SUITABLE STANDARD HEADS



## ACCESSORIES

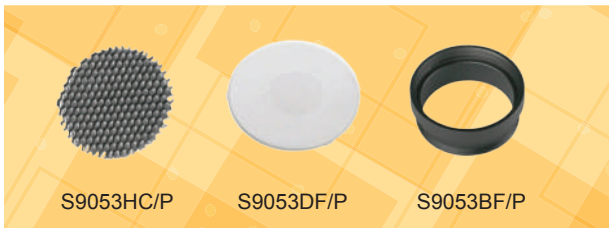

## EXPLOSION VIEW

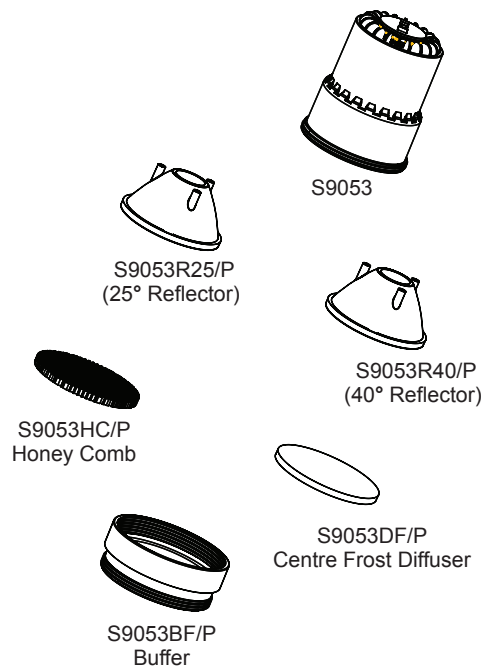

# DOWNLIGHT FITTING ASSEMBLED WITH LED MODULES

## S9006, S9007, S9008 UNIFIT



### DIMENSIONS

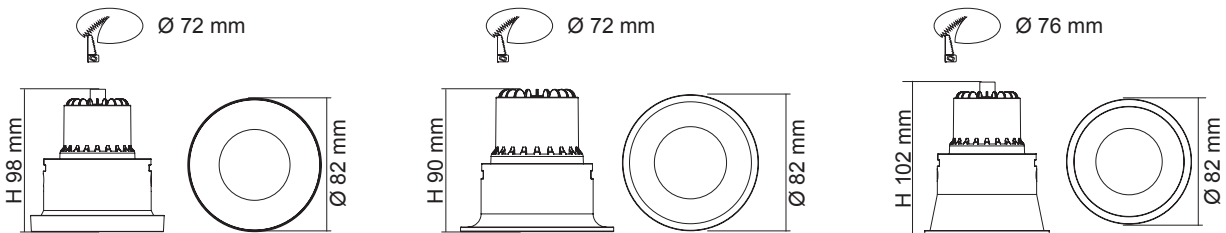

### CONSTRUCTION

- Die-cast aluminium body
- Powder coated finish
- High output COB LED chip
- Changeable multi-reflector system
- Polycarbonate optical lens
- Constant current trailing edge dimmable LED driver fitted
- 1.2 m flex & 2 pin plug fitted

### IP RATING

- IP20 suitable for interior use only

### DIMMING OPTIONS

- 1-10V analogue
- DALI / DSI, digital

### BEAM ANGLE

- 60° (standard)
- 25° reflector (option)
- 40° reflector (option)

Model No.	Input	Power	Lumen	CCT	Beam Angle	CRI	Dimmable	Fitting Colour
S9006WW	240V	9W	700lm	3000K	60°	>80	Yes*	Matt White
S9006CW	240V	9W	800lm	4000K	60°	>80	Yes*	Matt White
S9006DL	240V	9W	800lm	6000K	60°	>80	Yes*	Matt White
S9007WW	240V	9W	700lm	3000K	60°	>80	Yes*	Matt White
S9007CW	240V	9W	800lm	4000K	60°	>80	Yes*	Matt White
S9007DL	240V	9W	800lm	6000K	60°	>80	Yes*	Matt White
S9008WW	240V	9W	700lm	3000K	60°	>80	Yes*	Matt White
S9008CW	240V	9W	800lm	4000K	60°	>80	Yes*	Matt White
S9008DL	240V	9W	800lm	6000K	60°	>80	Yes*	Matt White

\*Trailing edge dimming



# DOWNLIGHT FITTING ASSEMBLED WITH LED MODULES

## S9009 UNIFIT, S9010 DECOFIT

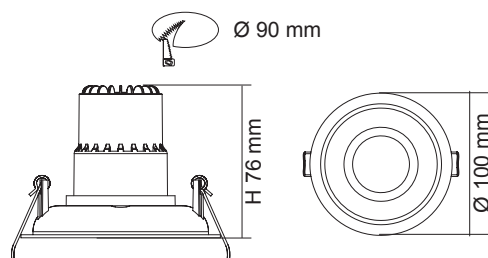
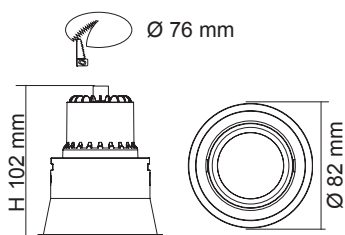

Model No.	Input	Power	Lumen	CCT	Beam Angle	CRI	Dimmable	Fitting Colour
S9009WW	240V	9W	700lm	3000K	60°	>80	Yes*	Matt White
S9009CW	240V	9W	800lm	4000K	60°	>80	Yes*	Matt White
S9009DL	240V	9W	800lm	6000K	60°	>80	Yes*	Matt White
S9010WW	240V	9W	700lm	3000K	60°	>80	Yes*	Matt White
S9010CW	240V	9W	800lm	4000K	60°	>80	Yes*	Matt White
S9010DL	240V	9W	800lm	6000K	60°	>80	Yes*	Matt White

\*Trailing edge dimming

### PHOTOMETRIC DATA Unit: cd C0/C180 — C90/C270

S9006WW, S9007WW, S9008WW,  
S9009WW, S9010WW

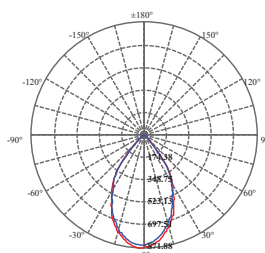

S9006CW, S9007CW, S9008CW,  
S9009CW, S9010CW

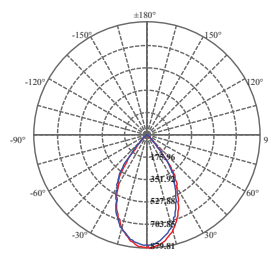

S9006DL, S9007DL, S9008DL,  
S9009DL, S9010DL

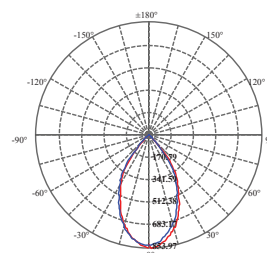

Specifications above are for reference only and may vary without prior notice





# LOW VOLTAGE LED DOWNLIGHT KIT (ROUND)

## S9001, S9002, S9003, S9004 DOWNLIGHT FITTINGS (PLEASE SELECT ONE)

Model No.	Head	Fitting Colour	Cut Out Size Ø	Dimensions Ø
S9001BK	Fixed head, twist lock	Black	72mm	81mm
S9001WH	Fixed head, twist lock	White	72mm	81mm
S9001SC	Fixed head, twist lock	Satin Chrome	72mm	81mm
S9001SN	Fixed head, twist lock	Satin Nickel	72mm	81mm
S9002WH	Centre tilt 30°, twist lock	White	80mm	95mm
S9002CH	Centre tilt 30°, twist lock	Chrome	80mm	95mm
S9002GL	Centre tilt 30°, twist lock	Gold	80mm	95mm
S9002SC	Centre tilt 30°, twist lock	Satin Chrome	80mm	95mm
S9002SN	Centre tilt 30°, twist lock	Satin Nickel	80mm	95mm
S9003BK	Gimble 45°, twist lock	Black	92mm	103mm
S9003WH	Gimble 45°, twist lock	White	92mm	103mm
S9003SC	Gimble 45°, twist lock	Satin Chrome	92mm	103mm
S9003SN	Gimble 45°, twist lock	Satin Nickel	92mm	103mm
S9004WH	Gimble 45°, rotatable 355°	White	94mm	103mm
S9004CH	Gimble 45°, rotatable 355°	Chrome	94mm	103mm
S9004SC	Gimble 45°, rotatable 355°	Satin Chrome	94mm	103mm
S9004SN	Gimble 45°, rotatable 355°	Satin Nickel	94mm	103mm



## PLUS

### LOW VOLTAGE LED GLOBES (PLEASE SELECT ONE)



Model No.	Input	Power	Lumen	CCT	Beam Angle	CRI	Dimmable	Lamp Base	Dimensions Ø x H
MR16 5W WW	12V AC / DC	5W	330lm	3000K	38°	>80	No	GU5.3	50 x 49 mm
MR16 5W DL	12V AC / DC	5W	350lm	6000K	38°	>80	No	GU5.3	50 x 49 mm
MR16/7W/WW	12V AC / DC	7W	500lm	3000K	60°	>80	No	GU5.3	50 x 49 mm
MR16/7W/DL	12V AC / DC	7W	550lm	6000K	60°	>80	No	GU5.3	50 x 49 mm
MR16DIM9W/WW	12V AC / DC	9W	500lm	3000K	60°	>80	Yes*	GU5.3	50 x 49 mm
MR16DIM9W/DL	12V AC / DC	9W	550lm	6000K	60°	>80	Yes*	GU5.3	50 x 49 mm

\*Trailing edge dimming

## OR

### DIMMABLE LED MODULES (PLEASE SELECT ONE)

Model No.	Input	Power	Lumen	CCT	Beam Angle	CRI	Dimmable
S9053 WP	240V	9W	700lm	3000K	60°	>80	Yes*
S9053 CP	240V	9W	800lm	4000K	60°	>80	Yes*
S9053 DP	240V	9W	800lm	6000K	60°	>80	Yes*

\*Trailing edge dimming

## PLUS (IF LOW VOLTAGE LED GLOBES SELECTED)

### ELECTRONIC TRANSFORMERS (PLEASE SELECT ONE)

Model No.	Input	Power	Output	Power Factor	Dimensions L x W x H	1.2 m flex & 2 pin plug fitted
MINI60	240V	20-60W	11.5V	0.99	109 x 42 x 24 mm	No
MINI/P60	240V	20-60W	11.5V	0.99	109 x 42 x 24 mm	Yes

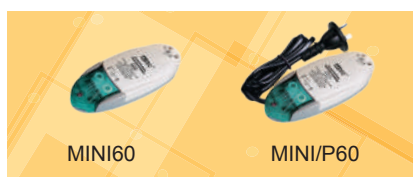

# LOW VOLTAGE LED DOWNLIGHT KIT (SQUARE)

## S9401, S9404, S9413 DOWNLIGHT FITTINGS (PLEASE SELECT ONE)

Model No.	Head	Fitting Colour	Cut Out Size Ø	Dimensions
S9404SN	Centre tilt 30°, twist lock	Satin Nickel	86 mm	92 x 92 mm
S9401CH	Centre tilt 30°, twist lock	Chrome	80mm	92mm x 92mm
S9401GL	Centre tilt 30°, twist lock	Gold	80mm	92mm x 92mm
S9401SC	Centre tilt 30°, twist lock	Satin Chrome	80mm	92mm x 92mm
S9401SN	Centre tilt 30°, twist lock	Satin Nickel	80mm	92mm x 92mm
S9413WH	Gimble 45°, twist lock	White	92mm	103mm x 103mm
S9413CH	Gimble 45°, twist lock	Chrome	92mm	103mm x 103mm
S9413GL	Gimble 45°, twist lock	Gold	92mm	103mm x 103mm
S9413SC	Gimble 45°, twist lock	Satin Chrome	92mm	103mm x 103mm



PLUS

## LOW VOLTAGE LED GLOBES (PLEASE SELECT ONE)



Model No.	Input	Power	Lumen	CCT	Beam Angle	CRI	Dimmable	Lamp Base	Dimensions Ø x H
MR16 5W WW	12V AC / DC	5W	330lm	3000K	38°	>80	No	GU5.3	50 x 49 mm
MR16 5W DL	12V AC / DC	5W	350lm	6000K	38°	>80	No	GU5.3	50 x 49 mm
MR16/7W/WW	12V AC / DC	7W	500lm	3000K	60°	>80	No	GU5.3	50 x 49 mm
MR16/7W/DL	12V AC / DC	7W	550lm	6000K	60°	>80	No	GU5.3	50 x 49 mm
MR16DIM9W/WW	12V AC / DC	9W	500lm	3000K	60°	>80	Yes*	GU5.3	50 x 49 mm
MR16DIM9W/DL	12V AC / DC	9W	550lm	6000K	60°	>80	Yes*	GU5.3	50 x 49 mm

\*Trailing edge dimming

OR

## DIMMABLE LED MODULES (PLEASE SELECT ONE)

Model No.	Input	Power	Lumen	CCT	Beam Angle	CRI	Dimmable
S9053 WP	240V	9W	700lm	3000K	60°	>80	Yes*
S9053 CP	240V	9W	800lm	4000K	60°	>80	Yes*
S9053 DP	240V	9W	800lm	6000K	60°	>80	Yes*

\*Trailing edge dimming

PLUS (IF LOW VOLTAGE LED GLOBES SELECTED)

## ELECTRONIC TRANSFORMERS (PLEASE SELECT ONE)

Model No.	Input	Power	Output	Power Factor	Dimensions L x W x H	1.2 m flex & 2 pin plug fitted
MINI60	240V	20-60W	11.5V	0.99	109 x 42 x 24 mm	No
MINI/P60	240V	20-60W	11.5V	0.99	109 x 42 x 24 mm	Yes

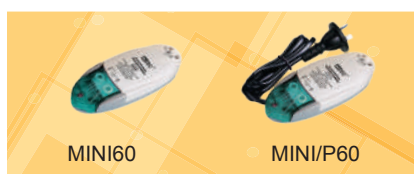

Dimmer/Switch  
Compatible



www.sal.net.au



# LED GU10 DOWNLIGHT KITS

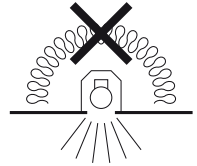

## GU10 DOWNLIGHT FITTINGS (PLEASE SELECT ONE)

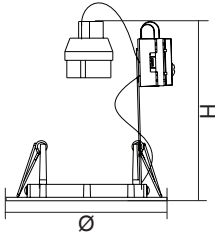

S9001 WH



S9003 SCH

Model No.	Head	Fitting Colour	Cut Out Size Ø	Dimensions H
S9001 SCH GU10	Fixed head, twist lock	Satin Chrome	72 mm	112 mm
S9001 WH GU10	Fixed head, twist lock	White	72 mm	112 mm
S9003 SCH GU10	Gimble 45°, twist lock	Satin Chrome	92 mm	112 mm
S9003 WH GU10	Gimble 45°, twist lock	White	92 mm	112 mm

## PLUS

## GU10 LED GLOBES (PLEASE SELECT ONE)



GU10L350, GU10L550

GU10LR750

GU10LA750

Model No.	Input	Power	Lumen	CCT	Beam Angle	CRI	Dimmable	Lamp Base
GU10L350WW	240V	4W	300lm	3000K	38°	>80	No	GU10
GU10L350CW	240V	4W	330lm	4000K	38°	>80	No	GU10
GU10L350DL	240V	4W	350lm	6000K	38°	>80	No	GU10
GU10L550WW	240V	6W	500lm	3000K	50°	>80	No	GU10
GU10L550CW	240V	6W	530lm	4000K	50°	>80	No	GU10
GU10L550DL	240V	6W	550lm	6000K	50°	>80	No	GU10
GU10LR750WW	240V	9W	700lm	3000K	60°	>80	No	GU10
GU10LR750CW	240V	9W	730lm	4000K	60°	>80	No	GU10
GU10LR750DL	240V	9W	750lm	6000K	60°	>80	No	GU10
GU10LA750WW	240V	9W	700lm	3000K	60°	>80	Yes*	GU10
GU10LA750CW	240V	9W	730lm	4000K	60°	>80	Yes*	GU10
GU10LA750DL	240V	9W	750lm	6000K	60°	>80	Yes*	GU10

\*Trailing edge dimming

# FIRE RATED DIMMABLE LED DOWNLIGHT

## S9902F-S9053 FIREFOX



### CONSTRUCTION

- Steel canister with anti-fire insulation
- Robust constructions, powder coated finish
- Fire rated: 120 mins
- Compliant with Australian standard AS1530.4
- S9053 LED module fitted
- Constant current trailing edge dimmable LED driver fitted

### IP RATING

- IP20 suitable for interior use only

### DIMMING OPTIONS

- 1-10V analogue
- DALI / DSI, digital

### BEAM ANGLE

- 60° (standard)
- 25° reflector (option)
- 40° reflector (option)



### DIMENSIONS

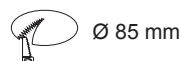

In the event of ceiling fire, the rise in temperature causes the insulation in the can to expand and thus closes the fitting ventilation holes, preventing the spread of fire between ceiling void and room.

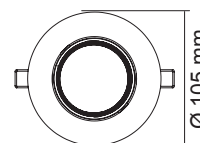
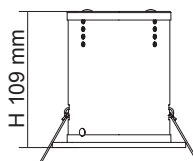

Model No.	Input	Power	Lumen	CCT	Beam Angle	CRI	Dimmable	Fitting Colour
S9902F/120-S9053 WP	240V	9W	700lm	3000K	60°	>80	Yes*	White
S9902F/120-S9053 CP	240V	9W	800lm	4000K	60°	>80	Yes*	White
S9902F/120-S9053 DP	240V	9W	800lm	6000K	60°	>80	Yes*	White

\*Trailing edge dimming

### PHOTOMETRIC DATA Unit: cd C0/C180 — C90/C270

S9902F-S9053 WP

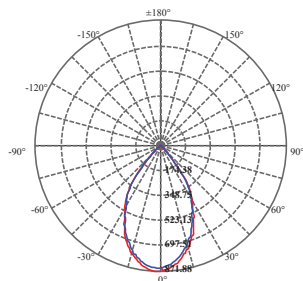

S9902F-S9053 CP

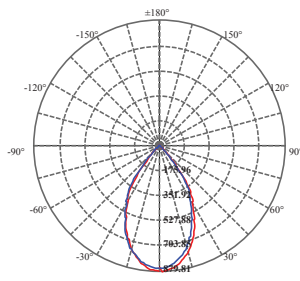

S9902F-S9053 DP

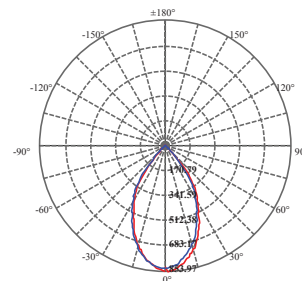

# DIMMABLE LED DOWNLIGHT

## L21022, L21021 EUROPA



### DIMENSIONS

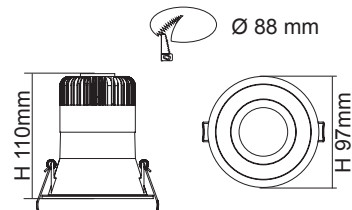
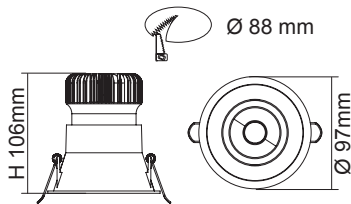

### CONSTRUCTION

- Die-cast aluminium body
- Powder coated finish
- High output COB LED chip
- Multi-reflector system
- Constant current trailing edge dimmable LED driver fitted
- 1.2 m flex & 2 pin plug fitted

### IP RATING

- IP20 suitable for interior use only

### DIMMING OPTIONS

- 1-10V analogue
- DALI / DSI, digital

Model No.	Input	Power	Lumen	CCT	Beam Angle	CRI	Dimmable	Fitting Colour
L21022 WW WH	240V	10W	700lm	3000K	60°	>85	Yes*	Matt White
L21021 WW WH	240V	10W	700lm	3000K	60°	>85	Yes*	Matt White

\*Trailing edge dimming

### PHOTOMETRIC DATA Unit: cd C0/C180 — C90/C270 —

L21022, L21021

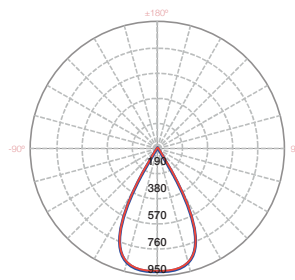

Specifications above are for reference only and may vary without prior notice

# LED SHOP LIGHT

## S9514TC ALBANY



### CONSTRUCTION

- Select colour temperature with DIP switch
- Twin 36W / 28W setting with DIP switch
- Adjustable up to 60°
- Die-cast aluminium body
- Powder coated finish
- Opal polycarbonate diffuser
- High efficiency SMD LED chips
- Constant current non-dimmable LED driver fitted
- 1.2 m flex & 2 pin plug fitted

### IP RATING

- IP20 suitable for interior use only

### DIMMING OPTIONS

- Trailing edge
- 1-10V analogue
- DALI / DSI, digital

### DIP SWITCH

- Twin 36W / 28W setting with DIP switch
- Select colour temperature with DIP switch

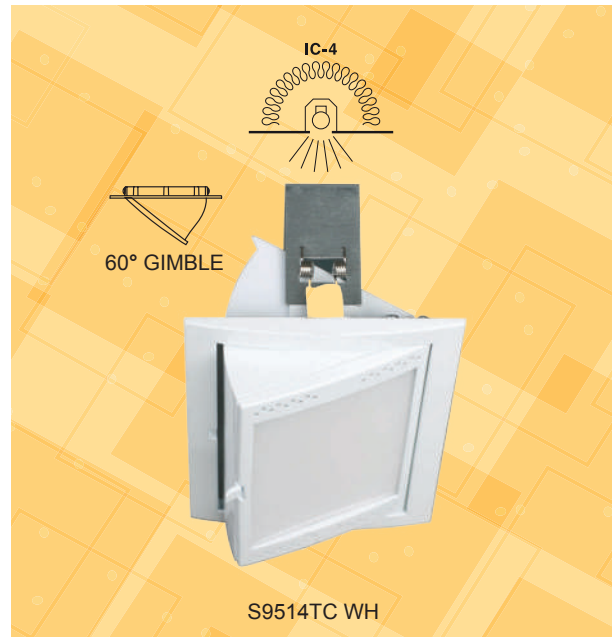
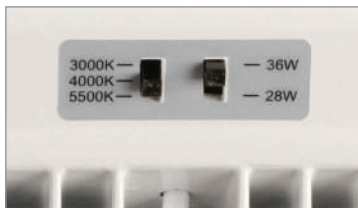

### DIMENSIONS

L x W: 215 x 130 mm

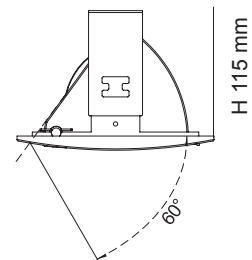
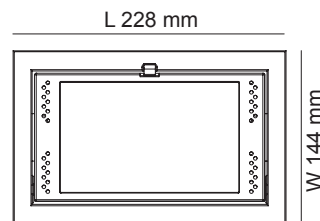

Model No.	Input	Power	Lumen	CCT	Beam Angle	CRI	Dimmable	Fitting Colour
S9514TC WH	240V	36W/28W	3600lm/2800lm	3000K/4000K/5500K	100°	>80	No	White
S9514TC SL	240V	36W/28W	3600lm/2800lm	3000K/4000K/5500K	100°	>80	No	Silver

### PHOTOMETRIC DATA (AT CCT 4000K) Unit: cd C0/C180 — C90/C270

S9514TC at 4000K and 36W

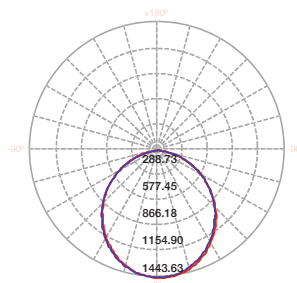

# LED SHOP LIGHT

## S9522TC, S9523TC EXMOUTH

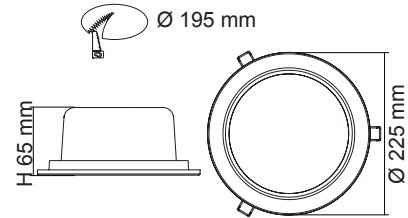
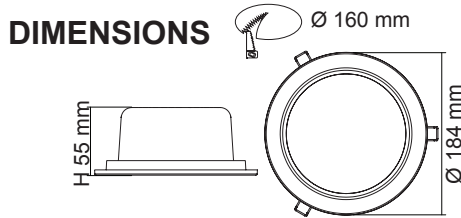

### CONSTRUCTION

- Select colour temperature with DIP switch
- Twin 22W / 15W setting with DIP switch (S9522TC)
- Twin 40W / 28W setting with DIP switch (S9523TC)
- Die-cast aluminium body
- Powder coated finish
- Opal polycarbonate diffuser
- High efficiency SMD LED chips
- Constant current non-dimmable LED driver fitted
- 1.2 m flex & 2 pin plug fitted

### DIMMING OPTIONS

- Trailing edge
- 1-10V analogue
- DALI / DSI, digital

### DIP SWITCH

- Twin wattage setting with DIP switch
- Select colour temperature with DIP switch



### IP RATING

- IP20 suitable for interior use only

Model No.	Input	Power	Lumen	CCT	Beam Angle	CRI	Dimmable	Fitting Colour
S9522TC WH	240V	22W / 15W	2100lm/1500lm	3000K/4000K/5500K	105°	>80	No	White
S9522TC SL	240V	22W / 15W	2100lm/1500lm	3000K/4000K/5500K	105°	>80	No	Silver
S9523TC WH	240V	40W / 28W	3800lm/2800lm	3000K/4000K/5500K	105°	>80	No	White
S9523TC SL	240V	40W / 28W	3800lm/2800lm	3000K/4000K/5500K	105°	>80	No	Silver

### PHOTOMETRIC DATA (AT CCT 4000K) Unit: cd C0/C180 — C90/C270

S9522TC at 4000K and 22W

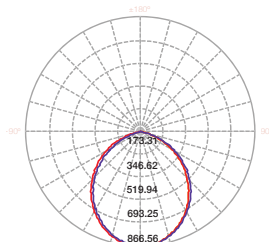

S9523TC at 4000K and 40W

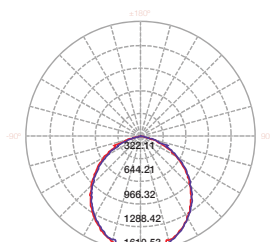

# SURFACE MOUNTED LED SHOP LIGHT

## S9523 SM EXMOUTH



### CONSTRUCTION

- Pressed steel casing
- Powder coated finish
- S9523 LED downlight kit included
- Constant current non-dimmable LED driver fitted

### IP RATING

- IP20 suitable for interior use only

### DIMMING OPTIONS

- Trailing edge
- 1-10V analogue
- DALI / DSI, digital

### DIP SWITCH

- Twin wattage setting with DIP switch
- Select colour temperature with DIP switch



### DIMENSIONS

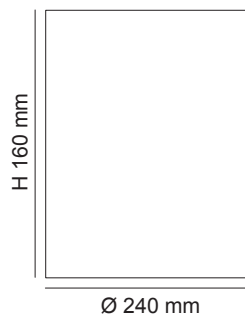

Model No.	Input	Power	Lumen	CCT	Beam Angle	CRI	Dimmable	Fitting Colour
S9523SM/C TC WH	240V	40W / 28W	3800lm/2800lm	3000K/4000K/5500K	105°	>80	No	White

### PHOTOMETRIC DATA (AT CCT 4000K) Unit: cd C0/C180 \_\_\_\_\_ C90/C270 \_\_\_\_\_

S9523TC at 4000K and 40W

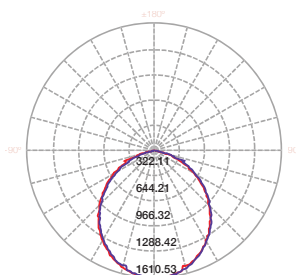



# DIMMABLE LED DOWNLIGHT

## S9071TC, S9072TC, S9073TC PREMIER

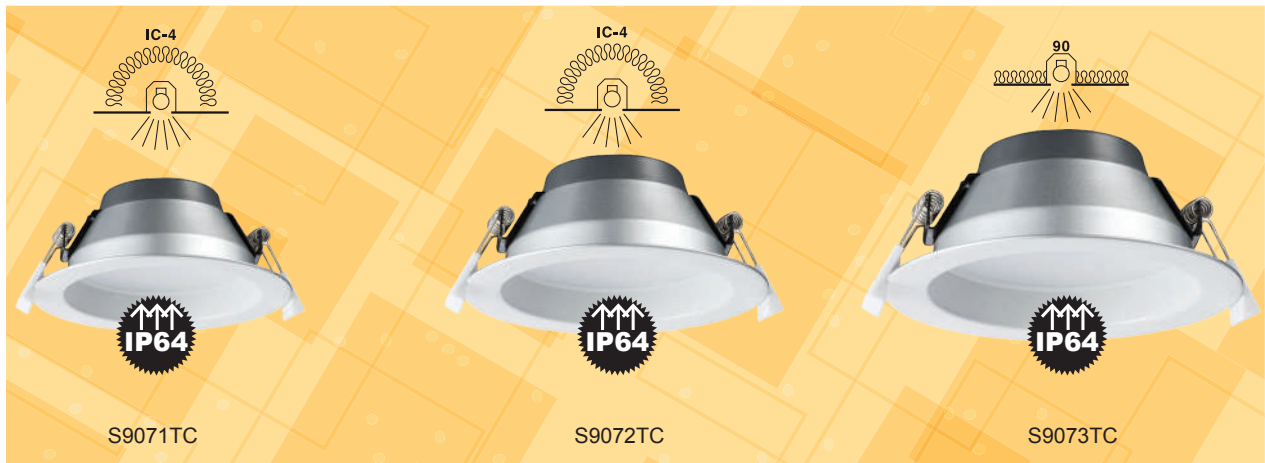

### DIMENSIONS

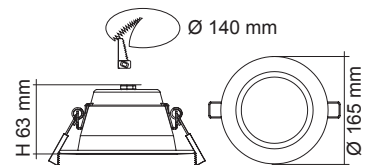
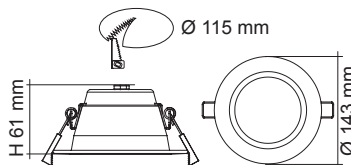
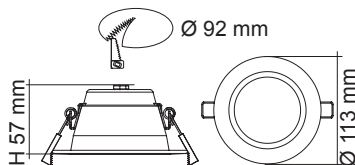

### CONSTRUCTION

- Premium aluminium body
- Powder coated finish
- Opal acrylic diffuser
- High efficiency SMD LED chips
- Constant current trailing edge dimmable LED driver fitted
- 1.2m flex & plug fitted

### IP RATING

- IP64 weatherproof front only

### DIMMING OPTIONS

- 1-10V analogue
- DALI / DSI, digital

Model No.	Input	Power	Lumen	CCT	Beam Angle	CRI	Dimmable	Fitting Colour
S9071TC WH	240V	10W	800lm/900lm/900lm	3000K/4000K/5700K	90°	>80	Yes*	White
S9071TC SL	240V	10W	800lm/900lm/900lm	3000K/4000K/5700K	90°	>80	Yes*	Silver
S9072TC WH	240V	14W	1000lm/1150lm/1150lm	3000K/4000K/5700K	90°	>80	Yes*	White
S9072TC SL	240V	14W	1000lm/1150lm/1150lm	3000K/4000K/5700K	90°	>80	Yes*	Silver
S9073TC WH	240V	18W	1400lm/1550lm/1550lm	3000K/4000K/5700K	90°	>80	Yes*	White
S9073TC SL	240V	18W	1400lm/1550lm/1550lm	3000K/4000K/5700K	90°	>80	Yes*	Silver

\*Trailing edge dimming

### PHOTOMETRIC DATA (AT CCT 4000K) Unit: cd C0/C180 — C90/C270

S9071TC at 4000K

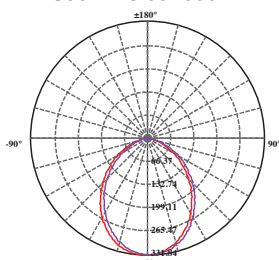

S9072TC at 4000K

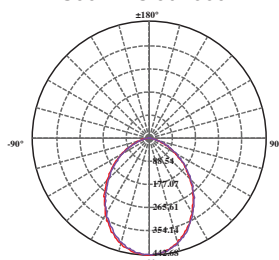

S9073TC at 4000K

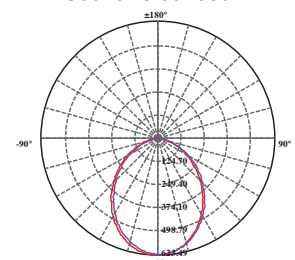



# LED DOWNLIGHT

## S9074TC, S9075TC, S9076TC PREMIER



### DIMENSIONS

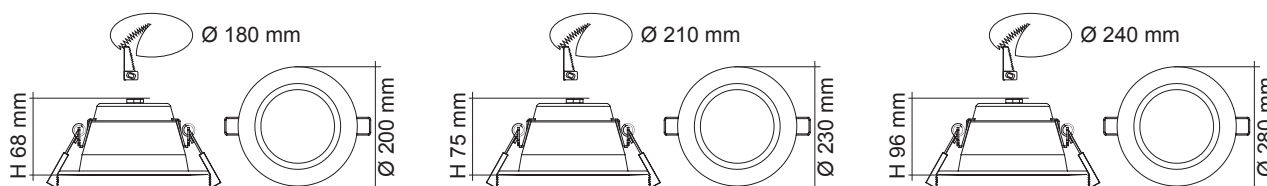

### CONSTRUCTION

- Premium aluminium body
- Powder coated finish
- Opal acrylic diffuser
- High efficiency SMD LED chips
- Constant current non-dimmable LED driver fitted
- 1.2m flex & plug fitted

### IP RATING

- IP64 weatherproof front only

### DIMMING OPTIONS

- Trailing edge (S9074 & S9075)
- 1-10V analogue
- DALI / DSI, digital

Model No.	Input	Power	Lumen	CCT	Beam Angle	CRI	Dimmable	Fitting Colour
S9074TC WH	240V	20W	1600lm/1800lm/1800lm	3000K/4000K/5700K	90°	>80	No	White
S9075TC WH	240V	30W	2600lm/2800lm/2800lm	3000K/4000K/5700K	90°	>80	No	White
S9076TC WH	240V	40W	3600lm/3900lm/3900lm	3000K/4000K/5700K	90°	>80	No	White

### PHOTOMETRIC DATA (AT CCT 4000K) Unit: cd C0/C180 — C90/C270

S9074TC at 4000K

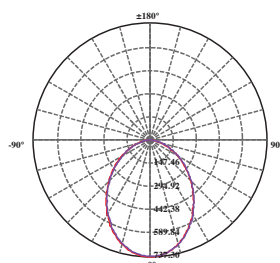

S9075TC at 4000K

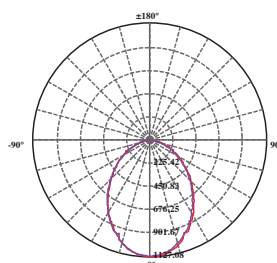

S9076TC at 4000K

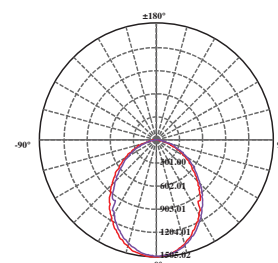

# LED SHOP LIGHT

## S9656, S9658 UNI LED



### CONSTRUCTION

- Die-cast aluminium body
- Powder coated finish
- High output COB LED chip
- Multi-reflector system
- Clear glass diffuser (Changeable)
- Constant current LED driver fitted
- 1.2 m flex & 2 pin plug fitted

### IP RATING

- IP54 weatherproof front only

### DIMMING OPTIONS

- Trailing edge (S9656 only)
- 1-10V analogue
- DALI / DSI, digital

### BEAM ANGLE

- 90°

### DIMENSIONS (S9656)

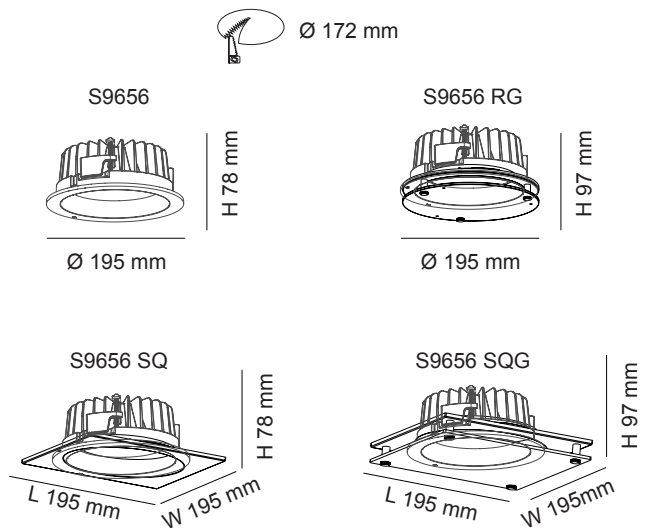

### DIMENSIONS (S9658)

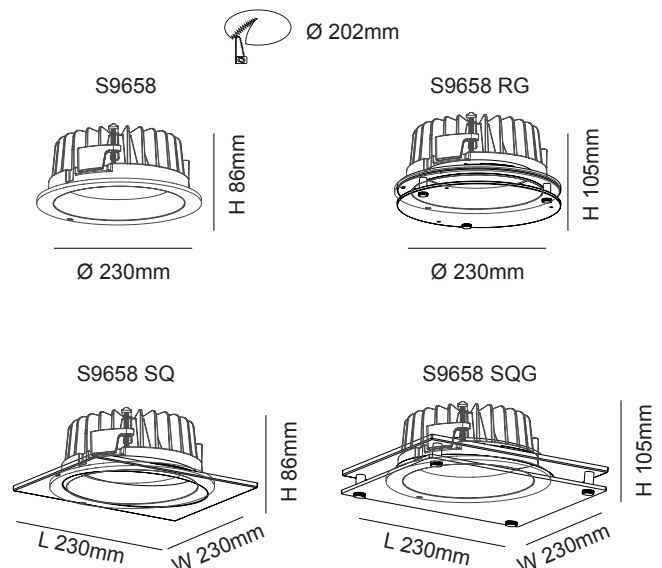

## SQUARE FACE COVER

## SQUARE FACE COVER WITH DROPPED GLASS



Model No.	Input	Power	Lumen	CCT	Beam Angle	CRI	Dimmable	Fitting Colour
S9656WW WH	240V	25W	2200lm	3000K	90°	>80	No	White
S9656WW WH SQ	240V	25W	2200lm	3000K	90°	>80	No	White
S9656WW BK	240V	25W	2200lm	3000K	90°	>80	No	Black
S9656WW BK SQ	240V	25W	2200lm	3000K	90°	>80	No	Black
S9656WW WH RG	240V	25W	2200lm	3000K	90°	>80	No	White
S9656WW WH SQG	240V	25W	2200lm	3000K	90°	>80	No	White

Model No.	Input	Power	Lumen	CCT	Beam Angle	CRI	Dimmable	Fitting Colour
S9656CW WH	240V	25W	2300lm	4000K	90°	>80	No	White
S9656CW WH SQ	240V	25W	2300lm	4000K	90°	>80	No	White
S9656CW BK	240V	25W	2300lm	4000K	90°	>80	No	Black
S9656CW BK SQ	240V	25W	2300lm	4000K	90°	>80	No	Black
S9656CW WH RG	240V	25W	2300lm	4000K	90°	>80	No	White
S9656CW WH SQG	240V	25W	2300lm	4000K	90°	>80	No	White

Model No.	Input	Power	Lumen	CCT	Beam Angle	CRI	Dimmable	Fitting Colour
S9658WW WH	240V	50W	4000lm	3000K	90°	>80	No	White
S9658WW WH SQ	240V	50W	4000lm	3000K	90°	>80	No	White
S9658WW BK	240V	50W	4000lm	3000K	90°	>80	No	Black
S9658WW BK SQ	240V	50W	4000lm	3000K	90°	>80	No	Black
S9658WW WH RG	240V	50W	4000lm	3000K	90°	>80	No	White
S9658WW WH SQG	240V	50W	4000lm	3000K	90°	>80	No	White

Model No.	Input	Power	Lumen	CCT	Beam Angle	CRI	Dimmable	Fitting Colour
S9658CW WH	240V	50W	4200lm	4000K	90°	>80	No	White
S9658CW WH SQ	240V	50W	4200lm	4000K	90°	>80	No	White
S9658CW BK	240V	50W	4200lm	4000K	90°	>80	No	Black
S9658CW BK SQ	240V	50W	4200lm	4000K	90°	>80	No	Black
S9658CW WH RG	240V	50W	4200lm	4000K	90°	>80	No	White
S9658CW WH SQG	240V	50W	4200lm	4000K	90°	>80	No	White

## PHOTOMETRIC DATA

Unit: cd

S9656 WW C0/C180 ———  
C90/C270 ———

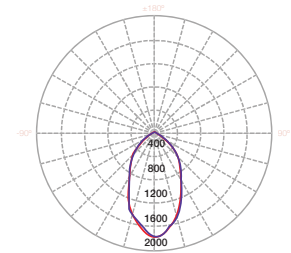

S9658 WW C0/C180 ———  
C90/C270 ———

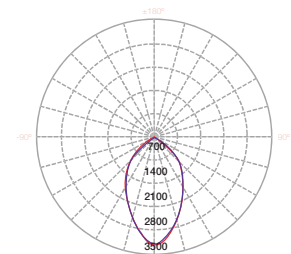

# LED SHOP LIGHT

## S9520 SEYMOUR, S9530 MANSFIELD

### DIMENSIONS

S9520

L x W: 165 x 165 mm



H 164 mm



W 189 mm

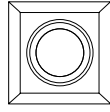

L 189 mm

S9530

L x W: 165 x 165 mm



H 178 mm

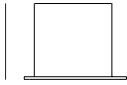

W 189 mm

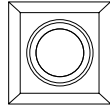

L 189 mm

S9520/2

L x W: 335 x 165 mm



H 164 mm

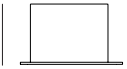

W 189 mm

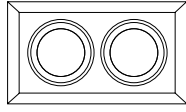

L 361 mm

S9530/2

L x W: 335 x 165 mm



H 178 mm

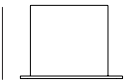

W 189 mm

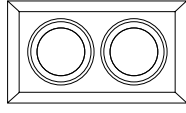

L 361 mm

S9520/3

L x W: 480 x 165 mm



H 164 mm



W 189 mm

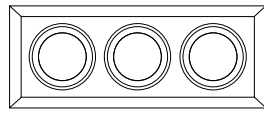

L 513 mm

S9530/3

L x W: 480 x 165 mm



H 178 mm

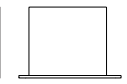

W 189 mm

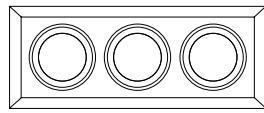

L 513 mm

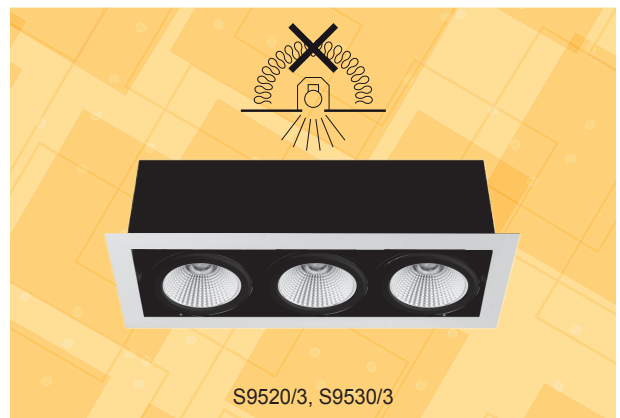

### PHOTOMETRIC DATA

Unit:cd

S9520/1700 WW

C0/C180

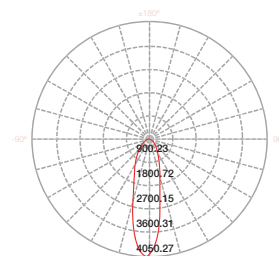



## CONSTRUCTION

- Pressed steel casing
- Powder coated finish
- LED AR111 module(s) & driver(s) included
- High output COB LED chip
- Specially designed optical lens
- Changeable multi-reflector system
- 1.2 m flex & 3 pin plug fitted

## IP RATING

- IP20 suitable for interior use only

## BEAM ANGLE

- 24° (standard)
- AR111/1700: 40° (option)
- AR111/3500: 20°, 60° (option)

## COLOUR TEMPERATURE

- 3000K Warm White (standard)
- AR111/1700: 4000K Cool White (standard)

## DIMMING OPTIONS (AR111/1700, AR111/3500)

- 1-10V analogue
- DALI / DSI, digital



Model No.	Input	Power	Lumen	CCT	Beam Angle	CRI	Dimmable	Fitting Colour	Cut out size L x W	Dimensions L x W x H
S9520/700 SL	240V	12W	750lm	3000K	24°	>80	Yes*	Silver	165 x 165	189 x 189 x 164
S9520/2x700 SL	240V	2 x 12W	1500lm	3000K	24°	>80	Yes*	Silver	360 x 165	361 x 189 x 164
S9520/3x700 WH	240V	3 x 12W	2250lm	3000K	24°	>80	Yes*	White	480 x 165	513 x 189 x 164
S9520/3x700 SL	240V	3 x 12W	2250lm	3000K	24°	>80	Yes*	Silver	480 x 165	513 x 189 x 164
S9520/1700 SL	240V	20W	1600lm	3000K	24°	>80	Yes*	Silver	165 x 165	189 x 189 x 164
S9520/2x1700 SL	240V	2 x 20W	3200lm	3000K	24°	>80	Yes*	Silver	360 x 165	361 x 189 x 164
S9520/3x1700 WH	240V	3 x 20W	4800lm	3000K	24°	>80	Yes*	White	480 x 165	513 x 189 x 164
S9520/3x1700 SL	240V	3 x 20W	4800lm	3000K	24°	>80	Yes*	Silver	480 x 165	513 x 189 x 164

\*Trailing edge dimming

Model No.	Input	Power	Lumen	CCT	Beam Angle	CRI	Dimmable	Fitting Colour	Cut out size L x W	Dimensions L x W x H
S9530/700 WH	240V	12W	750lm	3000K	24°	>80	Yes*	White	165 x 165	189 x 189 x 178
S9530/700 SL	240V	12W	750lm	3000K	24°	>80	Yes*	Silver	165 x 165	189 x 189 x 178
S9530/1700 WH	240V	20W	1600lm	3000K	24°	>80	Yes*	White	165 x 165	189 x 189 x 178
S9530/1700 SL	240V	20W	1600lm	3000K	24°	>80	Yes*	Silver	165 x 165	189 x 189 x 178
S9530/2x700 WH	240V	2 x 12W	1500lm	3000K	24°	>80	Yes*	White	360 x 165	361 x 189 x 178
S9530/2x700 SL	240V	2 x 12W	1500lm	3000K	24°	>80	Yes*	Silver	360 x 165	361 x 189 x 178
S9530/2x1700 WH	240V	2 x 20W	3200lm	3000K	24°	>80	Yes*	White	360 x 165	361 x 189 x 178
S9530/2x1700 SL	240V	2 x 20W	3200lm	3000K	24°	>80	Yes*	Silver	360 x 165	361 x 189 x 178
S9530/3x700 WH	240V	3 x 12W	2250lm	3000K	24°	>80	Yes*	White	480 x 165	513 x 189 x 178
S9530/3x700 SL	240V	3 x 12W	2250lm	3000K	24°	>80	Yes*	Silver	480 x 165	513 x 189 x 178
S9530/3x1700 WH	240V	3 x 20W	4800lm	3000K	24°	>80	Yes*	White	480 x 165	513 x 189 x 178
S9530/3x1700 SL	240V	3 x 20W	4800lm	3000K	24°	>80	Yes*	Silver	480 x 165	513 x 189 x 178
S9530/3500 WH	240V	35W	3300lm	3000K	40°	>80	No	White	165 x 165	189 x 189 x 178
S9530/3500 SL	240V	35W	3300lm	3000K	40°	>80	No	Silver	165 x 165	189 x 189 x 178
S9530/2x3500 WH	240V	2 x 35W	6600lm	3000K	40°	>80	No	White	360 x 165	361 x 189 x 178
S9530/2x3500 SL	240V	2 x 35W	6600lm	3000K	40°	>80	No	Silver	360 x 165	361 x 189 x 178
S9530/3x3500 WH	240V	3 x 35W	9900lm	3000K	40°	>80	No	White	480 x 165	513 x 189 x 178
S9530/3x3500 SL	240V	3 x 35W	9900lm	3000K	40°	>80	No	Silver	480 x 165	513 x 189 x 178

\*Trailing edge dimming

# LED SHOP LIGHT

## S9545 NEWMAN MKII

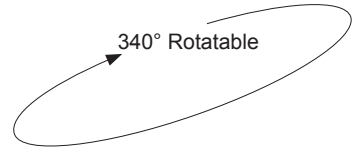

### CONSTRUCTION

- Die-cast aluminium body
- Powder coated finish
- Textured glass diffuser
- High efficiency SMD LED chips
- 60° multi-reflector system
- Constant current non-dimmable LED driver fitted
- 1.2 m flex & plug fitted

### IP RATING

- IP20 suitable for interior use only

### DIMMING OPTIONS

- 1-10V analogue
- DALI / DSI, digital



### DIMENSIONS

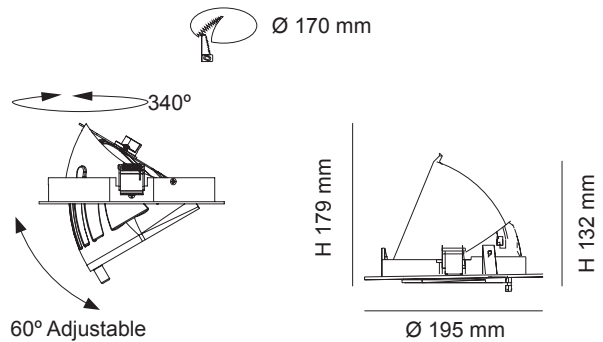

Model No.	Input	Power	Lumen	CCT	Beam Angle	CRI	Dimmable	Fitting Colour
S9545WW/WH	240V	38W	3600lm	3000K	60°	>80	No	White
S9545CW/WH	240V	38W	3700lm	4000K	60°	>80	No	White
S9545DL/WH	240V	38W	3800lm	5500K	60°	>80	No	White

### PHOTOMETRIC DATA Unit: cd C0/C180 — C90/C270

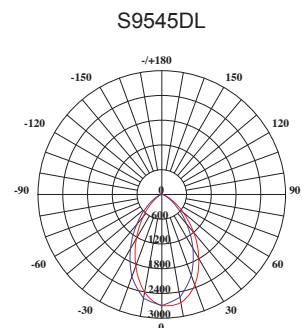
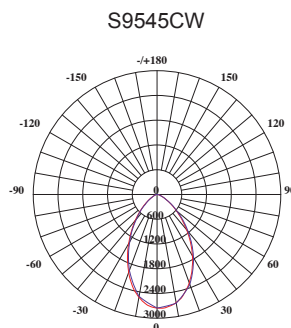
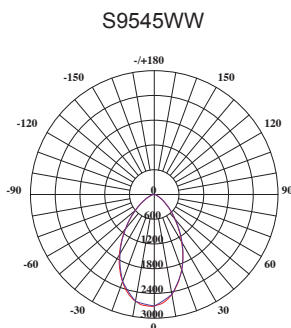







# LED SHOP LIGHT

## S9525 NEWMAN III

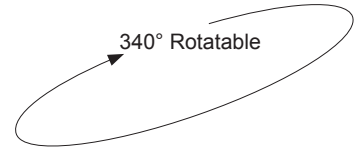

### DIMENSIONS

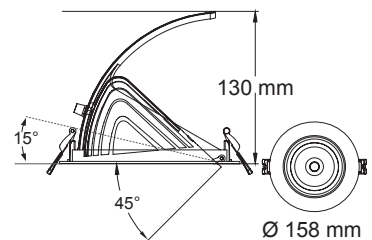
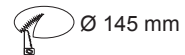
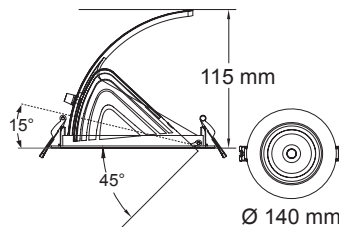
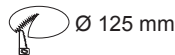
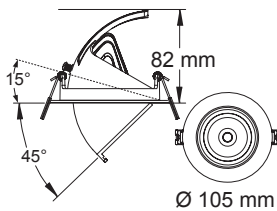
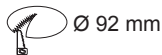

### CONSTRUCTION

- Die-cast aluminium body
- Powder coated finish
- A bracket mechanism ensures optimum tilting function 60° (-15° ~ +45°) and rotating 340°
- High output COB LED chip
- Specially designed optical lens
- Changeable multi-reflector system
- Constant current trailing edge dimmable LED driver fitted (S9525/92)
- Constant current non-dimmable LED driver fitted (S9525/125, S9525/145)
- 1.2 m flex & 2 pin plug fitted

### IP RATING

- IP20 suitable for interior use only

### DIMMING OPTIONS

- Trailing edge (excluding S9525/125)
- 1-10V analogue
- DALI / DSI, digital

### BEAM ANGLE

- 40° (standard)
- 24° (option)



Model No.	Input	Power	Lumen	CCT	Beam Angle	CRI	Dimmable	Fitting Colour
S9525/92WW/WH	240V	15W	1300lm	3000K	40°	>80	Yes*	White
S9525/92CW/WH	240V	15W	1400lm	4000K	40°	>80	Yes*	White
S9525/92DL/WH	240V	15W	1500lm	5700K	40°	>80	Yes*	White
S9525/125WW/WH	240V	25W	1900lm	3000K	40°	>80	No	White
S9525/125CW/WH	240V	25W	2000lm	4000K	40°	>80	No	White
S9525/125DL/WH	240V	25W	2100lm	5700K	40°	>80	No	White
S9525/145WW/WH	240V	35W	2600lm	3000K	40°	>80	No	White
S9525/145CW/WH	240V	35W	2700lm	4000K	40°	>80	No	White
S9525/145DL/WH	240V	35W	2800lm	5700K	40°	>80	No	White

\* Trailing edge dimming

**PHOTOMETRIC DATA** Unit: cd C0/C180 — C90/270

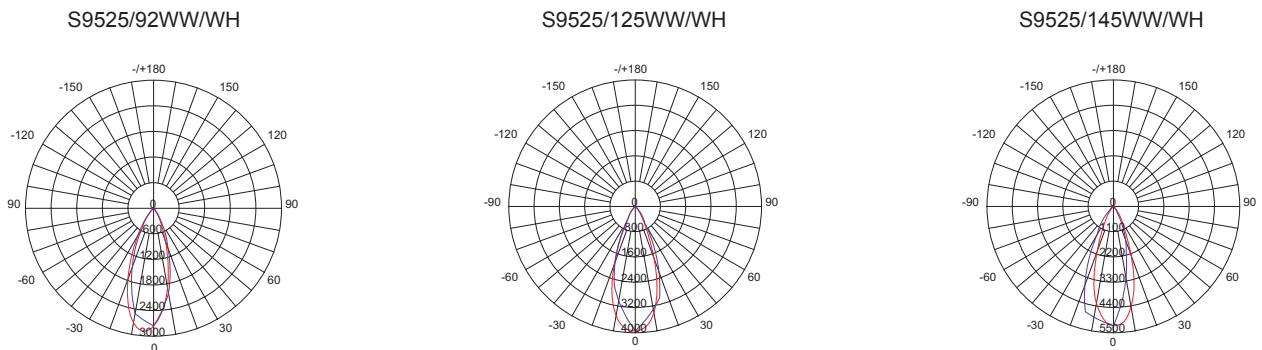

Specifications above are for reference only and may vary without prior notice



# LED WALL WASHER DOWNLIGHT

## S9681 WASH

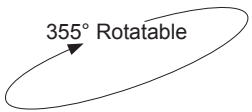

### CONSTRUCTION

- Can be both downlight or wall washer
- Die-cast aluminium body
- Powder coated finish
- A bracket mechanism ensures optimum tilting function 35° and rotating 355°
- High output COB LED chip
- High performance polished aluminium reflector
- Constant current non-dimmable LED driver fitted
- 1.2 m flex & 2 pin plug fitted

### IP RATING

- IP20 suitable for interior use only

### ACCESSORIES

- Honeycomb filter  
**S9681/55HC/P** suits **S9681/85**  
**S9681/115HC/P** suits **S9681/115**

### FITTING COLOUR

- White (standard)
- Black, Silver (option)

### BEAM ANGLE

- 36° (standard)
- 15°, 24°, 50° (option)

### COLOUR TEMPERATURE

- 4000K Cool White (standard)
- 3000K Warm White (option)
- 5000K Neutral Daylight (option)



### DIMENSIONS

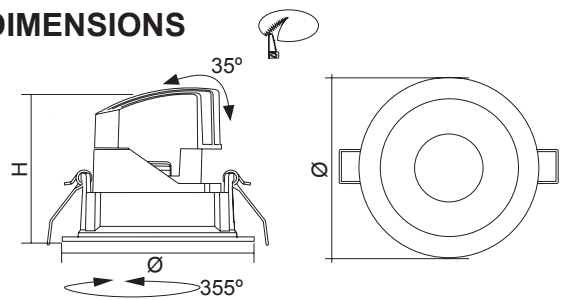

### DIMMING OPTIONS

- Trailing edge
- 1-10V analogue
- DALI / DSI, digital

Model No.	Input	Power	Lumen	CCT	Beam Angle	CRI	Fitting Colour	Cut Out Ø	Dimensions Ø x H
S9681/85CW	240V	8W	1000lm	4000K	36°	>80	White	75 mm	85 x 67 mm
S9681/115CW	240V	13W	1500lm	4000K	36°	>80	White	100 mm	115 x 100 mm

### PHOTOMETRIC DATA UNIT: cd C0/C180 — C90/C270 —

S9681/85CW (36°)

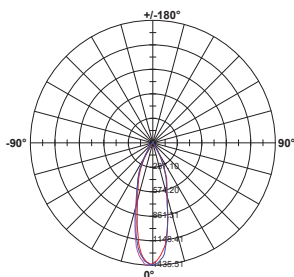

S9681/115CW (36°)

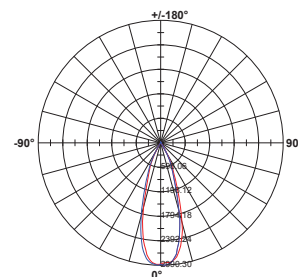

# LED SHOP LIGHT

## S9601 POP-EYE

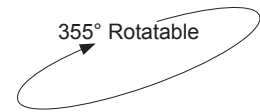

### CONSTRUCTION

- Die Cast Aluminium body
- Powder coated finish
- High output COB LED chip
- Hidden cable provides a clean architectural effect
- Changeable multi-reflector system
- Constant current non-dimmable LED driver fitted
- 1.2 m flex & 2 pin plug fitted

### IP RATING

- IP20 suitable for interior use only

### FITTING COLOUR

- White (standard)
- Black, Silver (option)

### BEAM ANGLE

- S9601/112: 36° (standard)
- S9601/140, S9601/188: 30° (standard)
- S9601/112: 15°, 24°, 50° (option)
- S9601/140, S9601/188 : 10°, 20°, 40°, 70° (option)

### COLOUR TEMPERATURE

- 4000K Cool White (standard)
- 3000K Warm White (option)
- 5000K Neutral Daylight (option)

### DIMMING OPTIONS

- Trailing edge (excluding S9601/188)
- 1-10V analogue
- DALI / DSI, digital



### DIMENSIONS

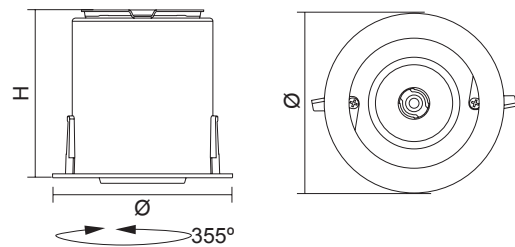

Model No.	Input	Power	Lumen	CCT	Beam Angle	CRI	Fitting Colour	Tilt	Cut Out Ø	Dimensions Ø x H
S9601/112/15CW	240V	13W	1500lm	4000K	36°	>80	White	70°	100 mm	112 x 106 mm
S9601/140/25CW	240V	18W	2500lm	4000K	30°	>80	White	90°	130 mm	140 x 167 mm
S9601/140/34CW	240V	25W	3400lm	4000K	30°	>80	White	90°	130 mm	140 x 167 mm
S9601/188/42CW	240V	34W	4200lm	4000K	30°	>80	White	90°	175 mm	188 x 194 mm
S9601/188/49CW	240V	38W	4900lm	4000K	30°	>80	White	90°	175 mm	188 x 194 mm

### PHOTOMETRIC DATA

UNIT: cd C0/C180 — C90/C270 —

S9601/112/15CW (24°)

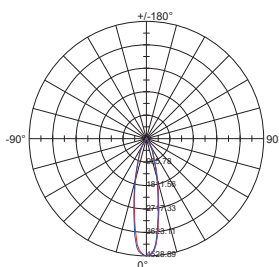

S9601/140/25CW (40°)

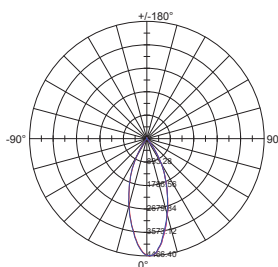

S9601/188/42CW (70°)

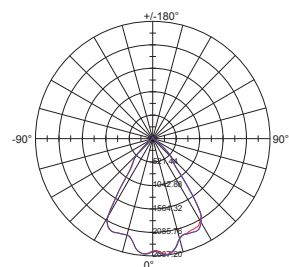



# LED SQUARE DOWNLIGHT

## S9691 BENTO

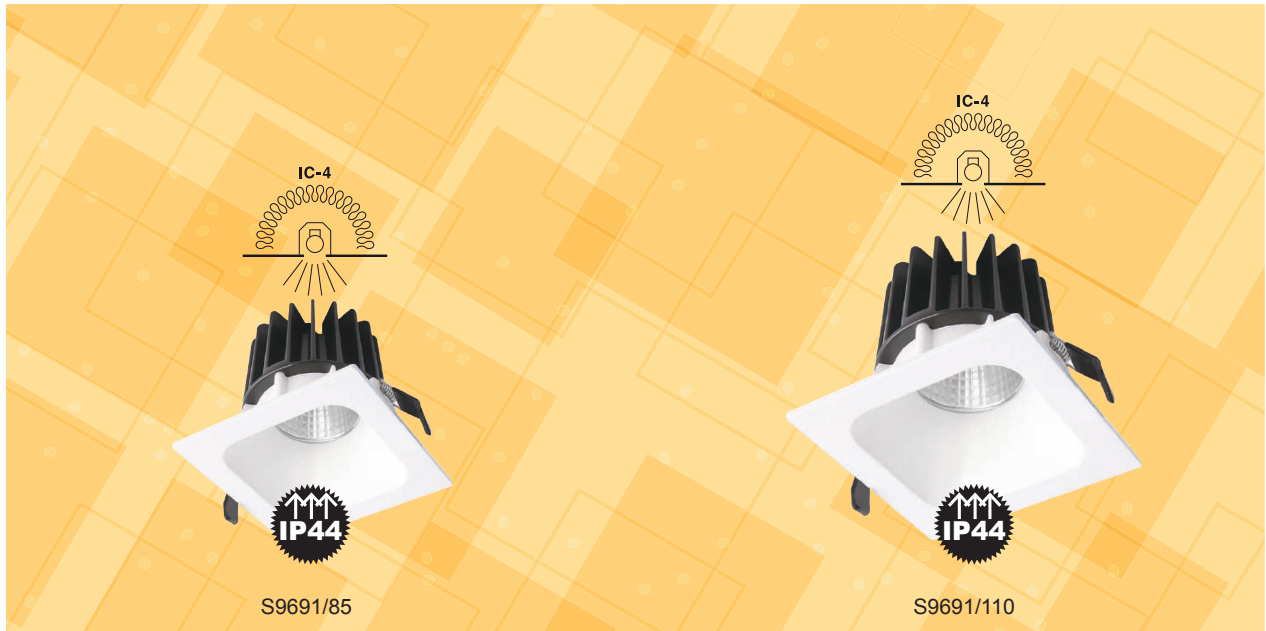

### DIMENSIONS



### CONSTRUCTION

- Square bezel combined with round body to suit round cut out
- Deep recessed angle fitting enables good glare control and light effect
- Die Cast Aluminium body
- Matt powder coated finish
- High output COB LED chip
- Changeable multi-reflector system
- Constant current non-dimmable LED driver fitted
- 1.2 m flex & 2 pin plug fitted

### IP RATING

- IP44 weatherproof front only

### FITTING COLOUR

- Matt white (standard)
- Black, Silver (option)

### BEAM ANGLE

- S9691/85, S9691/110: 36° (standard)
- S9691/135, S9691/160: 30° (standard)
- S9691/85, S9691/110: 15°, 24°, 50° (option)
- S9691/135, S9691/160 : 10°, 20°, 40°, 70° (option)

### COLOUR TEMPERATURE

- 4000K Cool White (standard)
- 3000K Warm White (option)
- 5000K Neutral Daylight (option)

### DIMMING OPTIONS

- Trailing edge (excluding S9691/135, S9691/160)
- 1-10V analogue
- DALI / DSI, digital



## DIMENSIONS



Model No.	Input	Power	Lumen	CCT	Beam Angle	CRI	Fitting Colour	Cut Out Ø	Dimensions L x H
S9691/85/7CW	240V	5W	700lm	4000K	36°	>80	Matt White	75	85 x 76 mm
S9691/85/10CW	240V	8W	1000lm	4000K	36°	>80	Matt White	75	85 x 76 mm
S9691/110/15CW	240V	13W	1500lm	4000K	36°	>80	Matt White	100	110 x 92 mm
S9691/135/34CW	240V	27W	3400lm	4000K	30°	>80	Matt White	125	135 x 127 mm
S9691/135/42CW	240V	34W	4200lm	4000K	30°	>80	Matt White	125	135 x 127 mm
S9691/135/49CW	240V	38W	4900lm	4000K	30°	>80	Matt White	125	135 x 127 mm
S9691/160/42CW	240V	34W	4200lm	4000K	30°	>80	Matt White	150	160 x 134 mm
S9691/160/49CW	240V	38W	4900lm	4000K	30°	>80	Matt White	150	160 x 134 mm

## PHOTOMETRIC DATA

UNIT: cd C0/C180 \_\_\_\_\_ C90/C270 \_\_\_\_\_

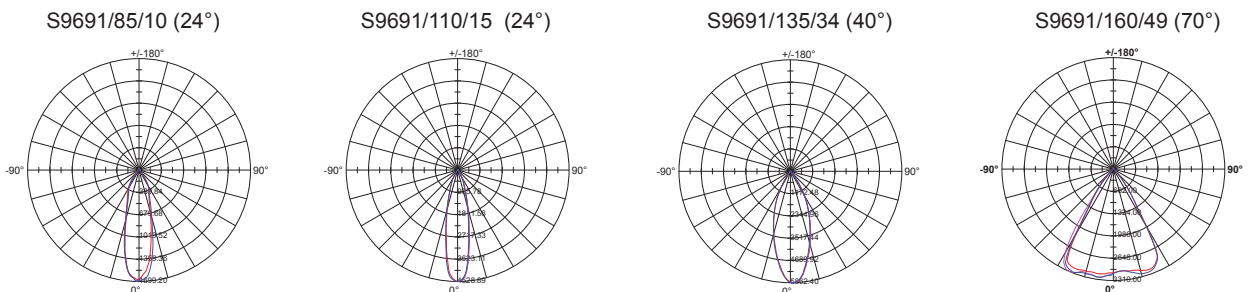

Dimmer/Switch  
Compatible



www.sal.net.au

# LED SQUARE DOWNLIGHT

## S9651 PUNNET



### DIMENSIONS

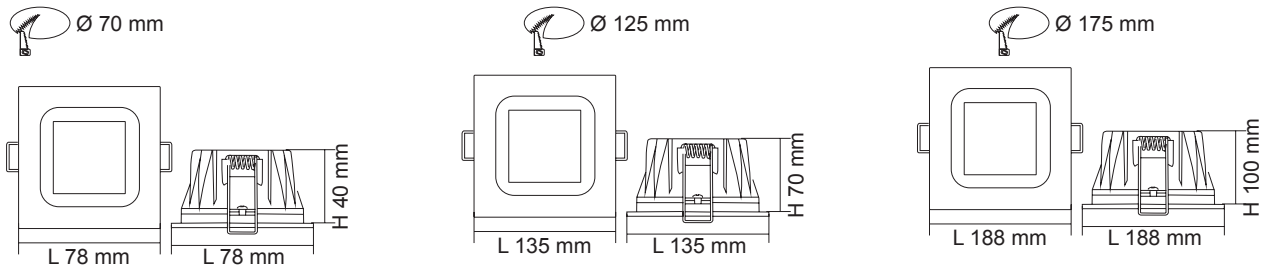

### CONSTRUCTION

- Square bezel combined with round body to suit round cut out
- Deep recessed angle fitting enables good glare control and light effect
- Die Cast Aluminium body
- Matt powder coated finish
- High efficiency SMD LED chips
- High efficiency prismatic diffuser
- Constant current non-dimmable LED driver fitted
- Trailing edge dimmable models available
- 1.2 m flex & 2 pin plug fitted

### IP RATING

- IP44 weatherproof front only

### COLOUR TEMPERATURE

- 4000K Cool White (standard)
- 3000K Warm White (option)
- 5000K Neutral Daylight (option)

### DIMMING OPTIONS

- Trailing edge (excluding S9651/175CW/WH50W)
- 1-10V analogue
- DALI / DSI, digital





Model No.	Input	Power	Lumen	CCT	Beam Angle	CRI	Dimmable	Fitting Colour
S9651/70CW/WH7W	240V	7W	800lm	4000K	80°	>80	Yes*	Matt White
S9651/70CW/WH10W	240V	10W	1000lm	4000K	80°	>80	Yes*	Matt White
S9651/125CW/WH20W	240V	20W	2000lm	4000K	80°	>80	No	Matt White
S9651/125CW/WH30W	240V	30W	2800lm	4000K	80°	>80	No	Matt White
S9651/175CW/WH35W	240V	35W	3500lm	4000K	80°	>80	No	Matt White
S9651/175CW/WH50W	240V	50W	4800lm	4000K	80°	>80	No	Matt White

\* Trailing edge dimming

**PHOTOMETRIC DATA** Unit: cd C0/C180 \_\_\_\_\_

S9651/70CW/WH7W

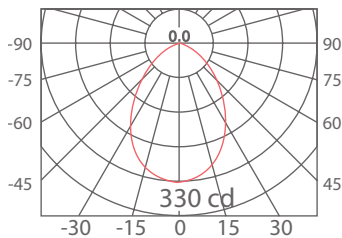

S9651/125CW/WH20W

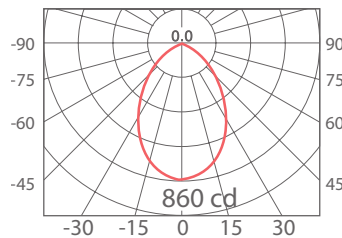

S9651/175CW/WH35W

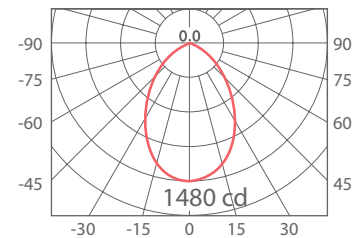

# SURFACE MOUNTED LED DOWNLIGHT

## S9603 COLUMN

### CONSTRUCTION

- 3 size options
- Surface mounted downlight with no-screw outside fitting providing a much cleaner design
- Die Cast Aluminium body
- Powder coated finish
- Deep recessed angle fitting enables good glare control and light effect
- High output COB LED chip
- Changeable multi-reflector system
- Built-in constant current non-dimmable LED driver



### IP RATING

- IP20 suitable for interior use only

### FITTING COLOUR

- Matt white (standard)
- Black, Silver (option)

### BEAM ANGLE

- 30° (standard)
- S9603/80: 10°, 20°, 40°, 50° (option)
- S9603/110, S9603/150: 10°, 20°, 40°, 70° (option)

### DIMENSIONS

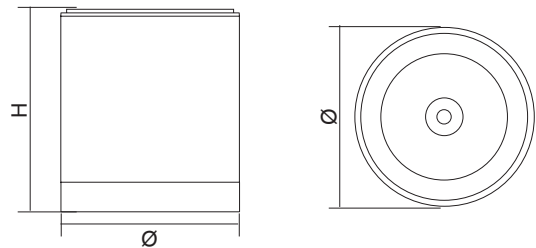

### COLOUR TEMPERATURE

- 4000K Cool White (standard)
- 3000K Warm White (option)
- 5000K Neutral Daylight (option)

Model No.	Input	Power	Lumen	CCT	Beam Angle	CRI	Fitting Colour	Dimensions Ø x H
S9603/80/15CW	240V	13W	1500lm	4000K	30°	>80	Matt White	80 x 126 mm
S9603/80/20CW	240V	20W	2000lm	4000K	30°	>80	Matt White	80 x 126 mm
S9603/110/25CW	240V	18W	2500lm	4000K	30°	>80	Matt White	110 x 148 mm
S9603/110/34CW	240V	28W	3400lm	4000K	30°	>80	Matt White	110 x 148 mm
S9603/150/42CW	240V	34W	4200lm	4000K	30°	>80	Matt White	150 x 171 mm
S9603/150/49CW	240V	38W	4900lm	4000K	30°	>80	Matt White	150 x 171 mm
S9603/150/62CW	240V	52W	6200lm	4000K	30°	>80	Matt White	150 x 171 mm

### PHOTOMETRIC DATA

UNIT: cd C0/C180 ——— C90/C270 ———

S9603/80/15CW (20°)

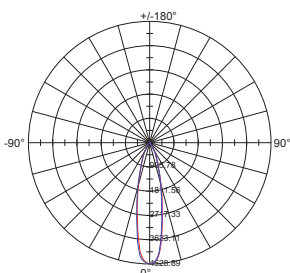

S9603/110/34CW (40°)

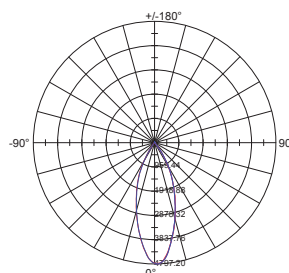

S9603/150/49CW (70°)

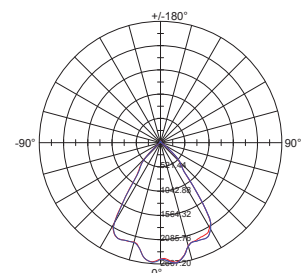

# SURFACE MOUNTED LED SQUARE DOWNLIGHT

## S9015 DICE

### CONSTRUCTION

- Surface mounted architectural square profile downlight
- Die-cast aluminium body
- High output COB LED chip
- Changeable multi-reflector system
- Polycarbonate optical lens
- Built-in constant current trailing edge dimmable LED driver (excluding S9015/80GU10)

### IP RATING

- IP20 suitable for interior use only

### FITTING COLOUR

- Black (standard)
- Matt white (option)

### BEAM ANGLE

- 60° optical reflector (standard)
- 25° optical reflector (option)
- 40° optical reflector (option)

### LAMP OPTIONS (S9015/80GU10)

- GU10L350 (lamp not included)
- GU10L550 (lamp not included)



### DIMENSIONS

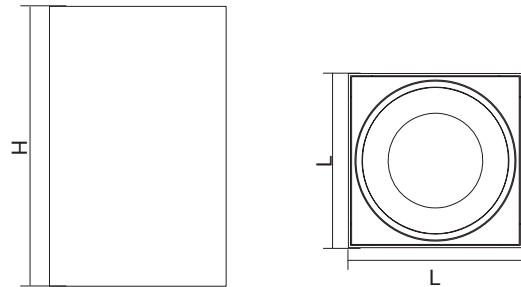

Model No.	Input	Power	Lumen	CCT	Beam Angle	CRI	Fitting Colour	Dimensions L x H
S9015/80WW/BK	240V	9W	700lm	3000K	60°	>80	Black	80 x 122 mm
S9015/80CW/BK	240V	9W	800lm	4000K	60°	>80	Black	80 x 122 mm
S9015/80DL/BK	240V	9W	800lm	6000K	60°	>80	Black	80 x 122 mm
S9015/80GU10/BK*	240V	Refer to GU10 lamp page for details					Black	80 x 122 mm
S9015/150WW/BK	240V	15W	1500lm	3000K	60°	>80	Black	150 x 247 mm
S9015/150CW/BK	240V	15W	1500lm	4000K	60°	>80	Black	150 x 247 mm
S9015/150DL/BK	240V	15W	1500lm	6000K	60°	>80	Black	150 x 247 mm

\* Lamp not included

### PHOTOMETRIC DATA UNIT: cd C0/C180 \_\_\_\_\_ C90/C270 \_\_\_\_\_

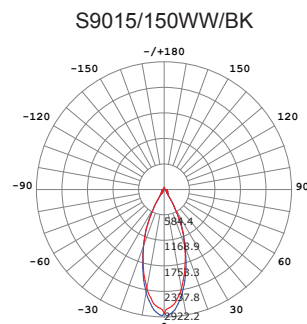
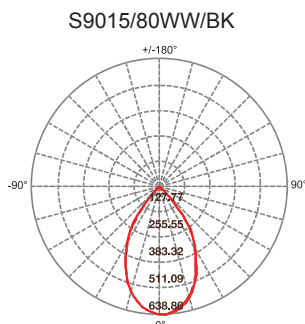

# SURFACE MOUNTED DIMMABLE LED DOWNLIGHT

## S9016, S9016/2, S9016/3 DICE II



### DIMENSIONS

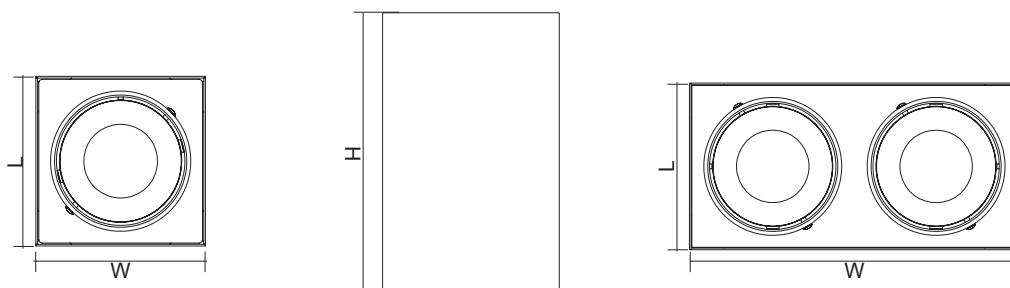

### CONSTRUCTION

- Surface mounted architectural rectangular profile downlight
- Centre tilt at each head
- Die-cast aluminium body
- High output COB LED chip
- Changeable multi-reflector system
- Polycarbonate optical lens
- Built-in constant current trailing edge dimmable LED driver

### IP RATING

- IP20 suitable for interior use only

### FITTING COLOUR

- Black (standard)
- Matt white (option)

### BEAM ANGLE

- 60° optical reflector (standard)
- 25° optical reflector (option)
- 40° optical reflector (option)



## DIMENSIONS

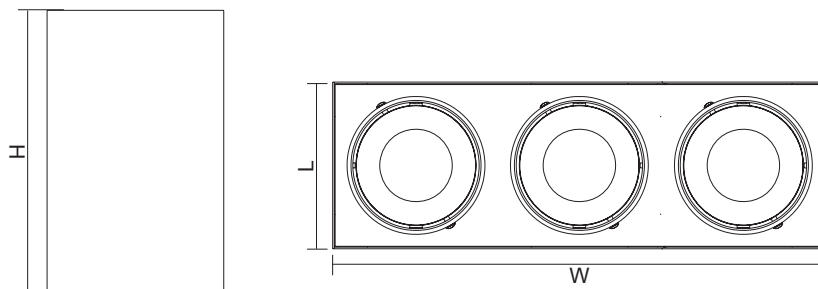

Model No.	Input	Power	Lumen	CCT	Beam Angle	CRI	Fitting Colour	Dimensions L x W x H
S9016WW/BK	240V	9W	700lm	3000K	60°	>80	Black	100 x 100 x 125 mm
S9016CW/BK	240V	9W	800lm	4000K	60°	>80	Black	100 x 100 x 125 mm
S9016DL/BK	240V	9W	800lm	6000K	60°	>80	Black	100 x 100 x 125 mm
S9016/2WW/BK	240V	2 x 9W	2 x 700lm	3000K	60°	>80	Black	100 x 198 x 125 mm
S9016/2CW/BK	240V	2 x 9W	2 x 800lm	4000K	60°	>80	Black	100 x 198 x 125 mm
S9016/2DL/BK	240V	2 x 9W	2 x 800lm	6000K	60°	>80	Black	100 x 198 x 125 mm
S9016/3WW/BK	240V	3 x 9W	3 x 700lm	3000K	60°	>80	Black	100 x 296 x 125 mm
S9016/3CW/BK	240V	3 x 9W	3 x 800lm	4000K	60°	>80	Black	100 x 296 x 125 mm
S9016/3DL/BK	240V	3 x 9W	3 x 800lm	6000K	60°	>80	Black	100 x 296 x 125 mm

## PHOTOMETRIC DATA UNIT: cd C0/C180 \_\_\_\_\_ C90/C270 \_\_\_\_\_

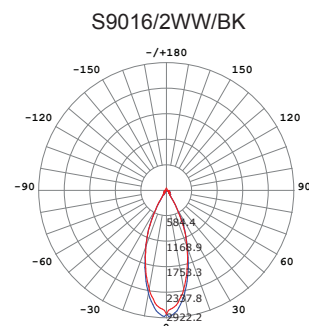
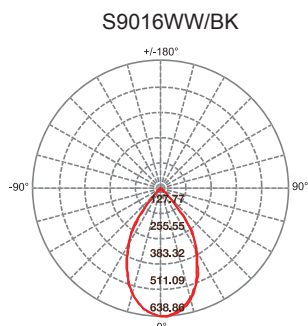

Dimmer/Switch  
Compatible



www.sal.net.au





[www.sal.net.au](http://www.sal.net.au)

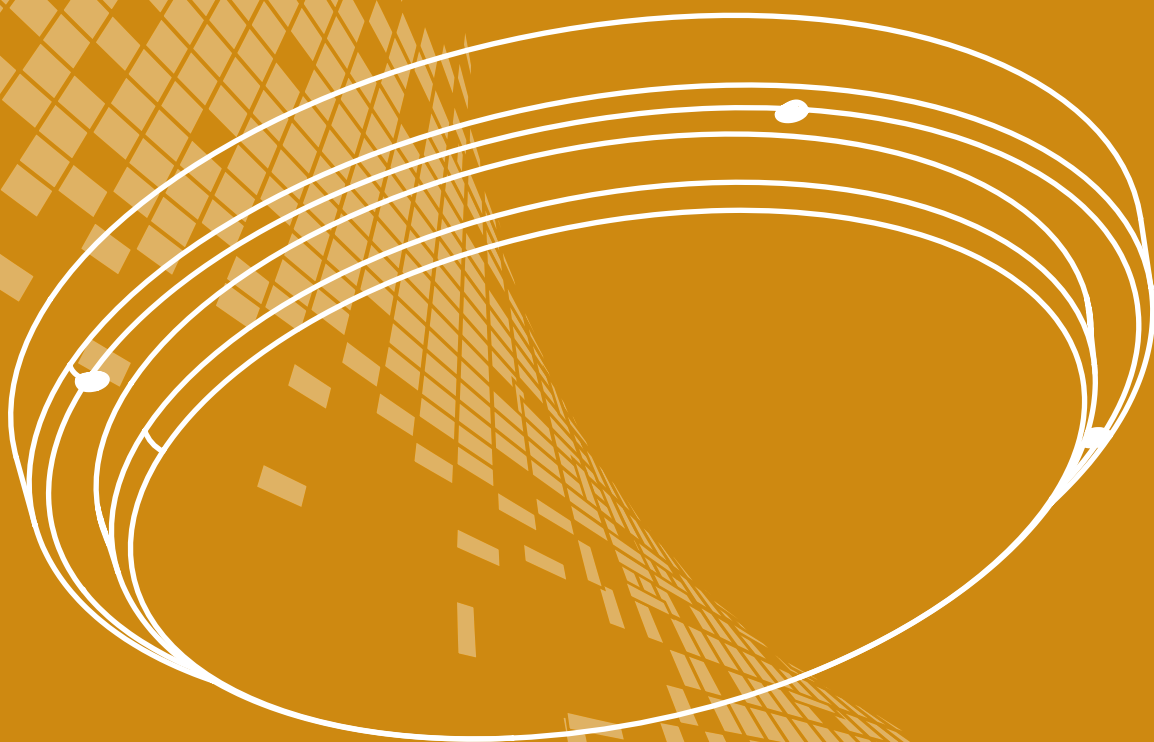

# LED OYSTER & PENDANT LIGHTS

## NEW PRODUCTS



p72  
SO3800 TC OPAL II



p75  
SL3247 CUSHION



p76  
SL2106TC BENNY



p79  
SL2111 DISCUS



p82  
SO3000 HALO



p83  
SPL3000 HALO



p84  
SL2110 FLAT



p92  
SPL020 PIP



p93  
SPL9017 UNITREK

# LED OYSTER LIGHT

## SO3700 OPAL



### DIMENSIONS

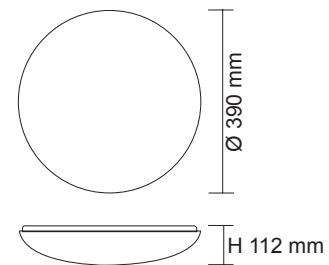
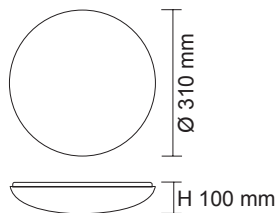

### CONSTRUCTION

- Powder coated steel base
- Opal polycarbonate diffuser
- High efficiency SMD LED chips
- Constant current non-dimmable LED driver fitted
- Select colour temperature with DIP switch (TC models)

### DIMMING OPTIONS

- Trailing edge
- 1-10V analogue (SO3700/40L only)
- DALI / DSI, digital (SO3700/40L only)

### SENSOR OPTION

- Integrated microwave motion sensor (SO3700/40L only)

### IP RATING

- IP20 suitable for interior use only

Model No.	Input	Power	Lumen	CCT	CRI	Dimensions Ø x H
SO3700/30L TC	240V	18W	1400lm/1500lm/1500lm	3000K/4000K/6000K	>80	310 x 100 mm
SO3700/40L TC	240V	30W	2500lm/2600lm/2600lm	3000K/4000K/6000K	>80	390 x 112 mm

### SO3700: DAYLIGHT OPTION AVAILABLE

Model No.	Input	Power	Lumen	CCT	CRI	Dimensions Ø x H
SO3700/30L DL	240V	18W	1600lm	6000K	>80	310 x 100 mm
SO3700/40L DL	240V	30W	2700lm	6000K	>80	390 x 112 mm

# LED OYSTER LIGHT

## SO3701 GEM

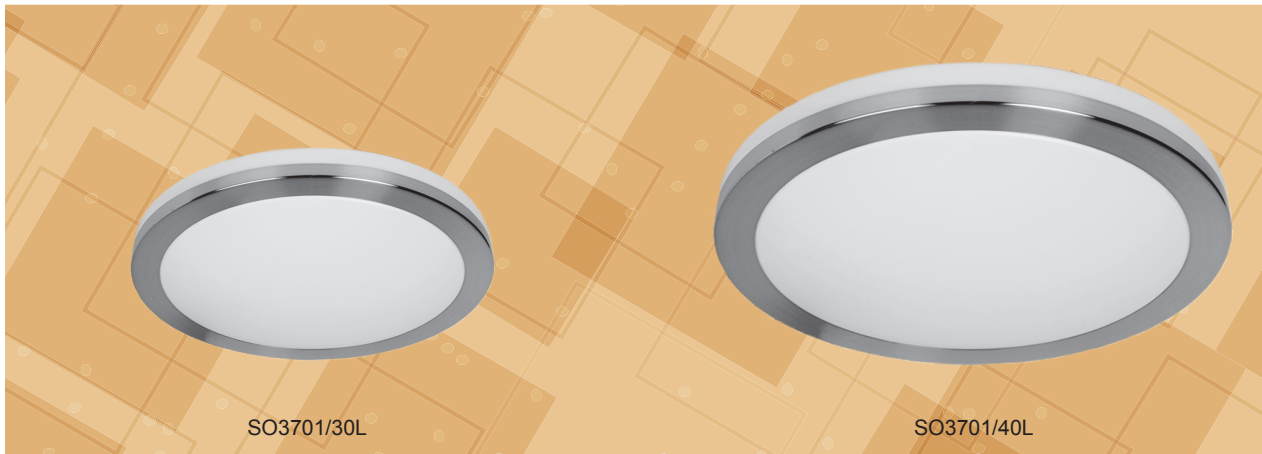

### DIMENSIONS

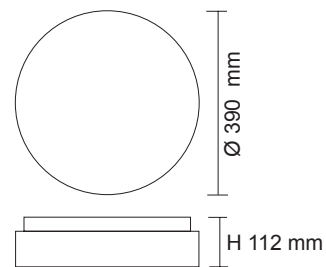
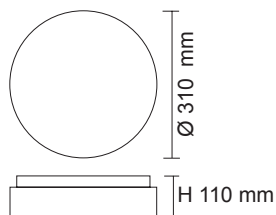

### CONSTRUCTION

- Select colour temperature with DIP switch
- Powder coated steel base
- Satin Nickel plated deco ring
- Opal polycarbonate diffuser
- High efficiency SMD LED chips
- Constant current non-dimmable LED driver fitted

### DIMMING OPTIONS

- Trailing edge
- 1-10V analogue (SO3701/40L only)
- DALI / DSI, digital (SO3701/40L only)

### SENSOR OPTION

- Integrated microwave motion sensor (SO3701/40L only)

### IP RATING

- IP20 suitable for interior use only

Model No.	Input	Power	Lumen	CCT	CRI	Dimensions Ø x H
SO3701/30L TC	240V	18W	1400lm/1500lm/1500lm	3000K/4000K/6000K	>80	310 x 100 mm
SO3701/40L TC	240V	30W	2500lm/2600lm/2600lm	3000K/4000K/6000K	>80	390 x 112 mm

# COMMERCIAL LED OYSTER LIGHT

## SO3800 TC OPAL II



### DIMENSIONS

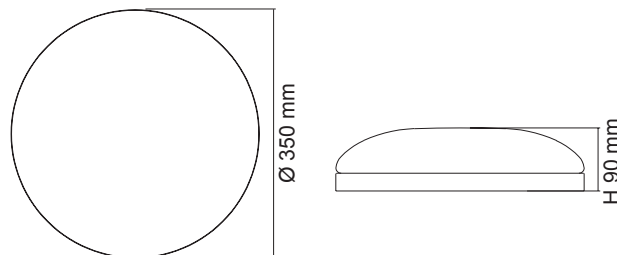

### CONSTRUCTION

- Colour temperature selectable by DIP switch
- Built-in constant current trailing edge dimmable LED driver (excluding SO3800/40TC/S, SO3800/40TC/EMS)
- Powder coated steel body
- Opal polycarbonate diffuser
- High efficiency SMD LED chips

### IP RATING

- IP20 suitable for interior use only

### FITTING COLOUR

- White

### SENSOR MODELS

(SO3800/40TC/S, SO3800/40TC/EMS):

- Adjustable sensor detection range
- Adjustable daylight threshold
- Adjustable duration
- Non-dimmable



### EMERGENCY MODELS

(SO3800/40TC/EM, SO3800/40TC/EMS):

- Compliant to AS2293
- LiFePO<sub>4</sub> battery







Model No.	Input	Power	Lumen	CCT	CRI	Dimmable	Emergency	Sensor
SO3800/40TC	240V	30W	2400lm/2600lm/2500lm	3000K/4000K/5700K	>80	Yes*		
SO3800/40TC/EM	240V	30W	2400lm/2600lm/2500lm	3000K/4000K/5700K	>80	Yes*	✓	
SO3800/40TC/S	240V	30W	2400lm/2600lm/2500lm	3000K/4000K/5700K	>80	No		✓
SO3800/40TC/EMS	240V	30W	2400lm/2600lm/2500lm	3000K/4000K/5700K	>80	No	✓	✓

\* Trailing edge dimming

**PHOTOMETRIC DATA (AT CCT 4000K)** Unit: cd C0/C180 — C90/C270 —

SO3800/40TC at 4000K

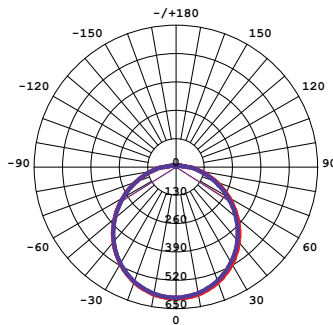

# DIMMABLE LED OYSTER LIGHT

## SL2105 DISC



### DIMENSIONS

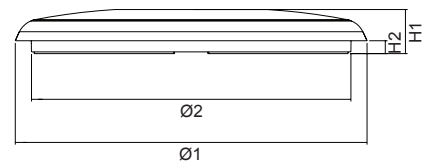
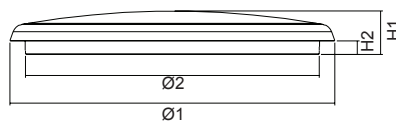
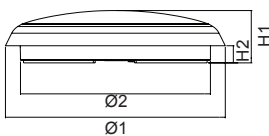

### CONSTRUCTION

- Polycarbonate housing
- Opal polycarbonate diffuser
- Double insulation
- High efficiency SMD LED chips
- Built-in constant current trailing edge dimmable LED driver

### IP RATING

- IP54 weatherproof

Model No.	Input	Power	Lumen	CCT	CRI	Fitting Colour	Dimensions Ø1 x H1, Ø2 x H2
SL2105/20WW	240V	12W	1050lm	3000K	>80	White	200 x 48 mm, 173 x 16 mm
SL2105/20DL	240V	12W	1100lm	5000K	>80	White	200 x 48 mm, 173 x 16 mm
SL2105/30WW	240V	25W	2000lm	3000K	>80	White	300 x 40 mm, 271 x 13 mm
SL2105/30DL	240V	25W	2200lm	5000K	>80	White	300 x 40 mm, 271 x 13 mm
SL2105/40WW	240V	30W	2800lm	3000K	>80	White	400 x 52 mm, 363 x 15 mm
SL2105/40DL	240V	30W	2900lm	5000K	>80	White	400 x 52 mm, 363 x 15 mm

### PHOTOMETRIC DATA

Unit: cd C0/C180 — C90/C270

SL2105/20DL

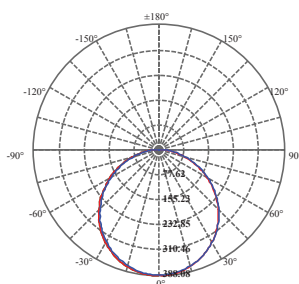

SL2105/30DL

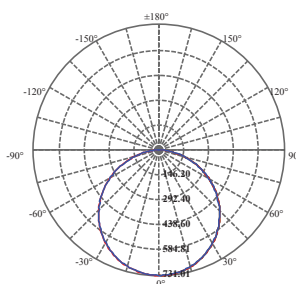

SL2105/40DL

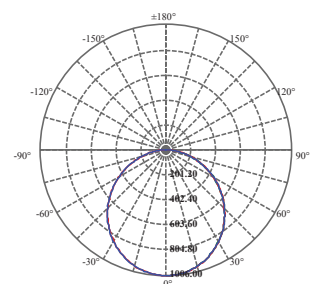

# DIMMABLE LED SQUARE OYSTER LIGHT

## SL3247 CUSHION



### CONSTRUCTION

- 4 size options
- Soft square architectural design
- Polycarbonate housing
- Opal polycarbonate diffuser
- Double insulation 
- High efficiency SMD LED chips
- Built-in constant current trailing edge dimmable LED driver

### IP RATING

- IP54 weatherproof

### COLOUR TEMPERATURE

- 4000K Cool White (standard)
- 3000K Warm White (option)
- 5700K Daylight (option)



### SENSOR OPTION

- Integrated microwave motion sensor (SL3247/25 only)

### DIMENSIONS

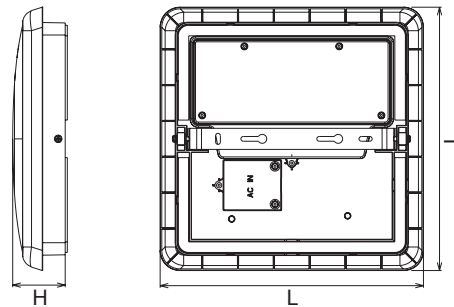

Model No.	Input	Power	Lumen	CCT	CRI	Fitting Colour	Dimensions L x H
SL3247/25CW	240V	12W	1000lm	4000K	>80	White	250 x 50 mm
SL3247/30CW	240V	18W	1600lm	4000K	>80	White	300 x 40 mm
SL3247/35CW	240V	25W	2400lm	4000K	>80	White	350 x 40 mm
SL3247/40CW	240V	30W	2500lm	4000K	>80	White	400 x 50 mm

### PHOTOMETRIC DATA

UNIT: cd C0/C180 — C90/C270 —

SL3247/25CW

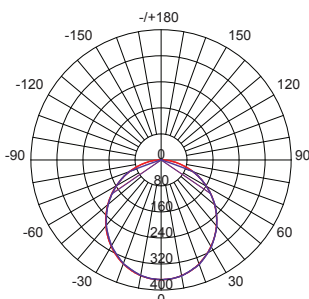

SL3247/30CW

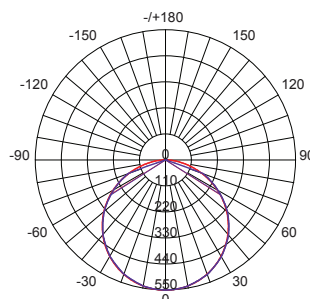

SL3247/40CW

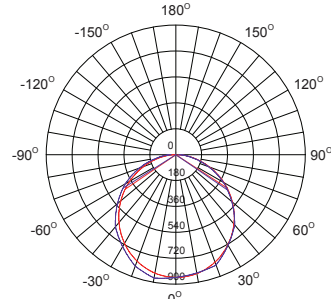

# LED OYSTER LIGHT

## SL2106TC BENNY

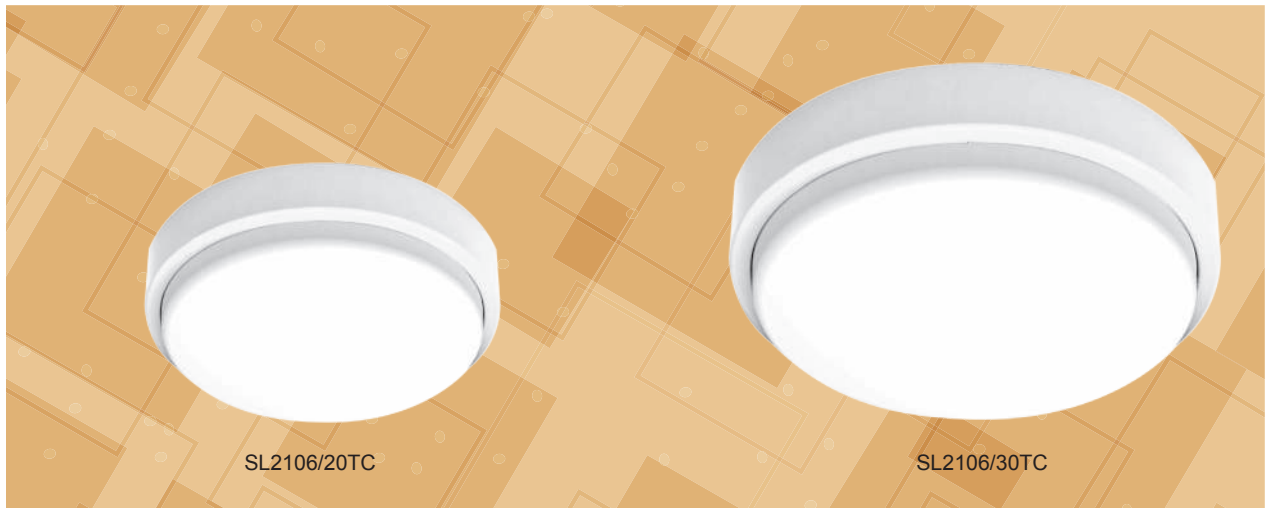

### DIMENSIONS

\*FC = Fixing Centres

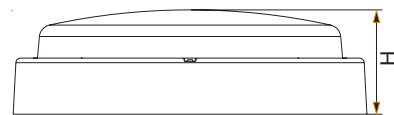
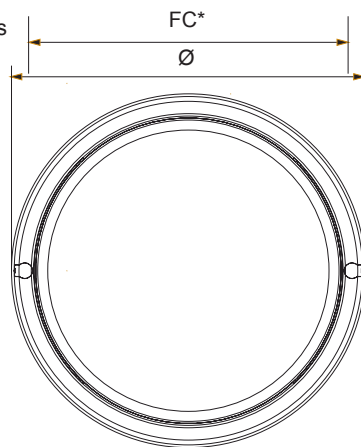

### CONSTRUCTION

- Select colour temperature with DIP switch
- Polycarbonate housing
- Opal polycarbonate diffuser
- Double insulation
- High efficiency SMD LED chips
- Built-in constant current non-dimmable LED driver

### IP RATING

- IP65 weatherproof

Model No.	Input	Power	Lumen	CCT	CRI	Fitting Colour	Dimensions Ø x H	FC*
SL2106/20TC	240V	10W	800lm	3000K/4000K/6000K	>80	White	220 mm x 65 mm	204 mm
SL2106/30TC	240V	20W	1600lm	3000K/4000K/6000K	>80	White	280 mm x 71 mm	263 mm
SL2106/30TC/S	240V	20W	1600lm	3000K/4000K/6000K	>80	White	280 mm x 71 mm	263 mm
SL2106/40TC	240V	24W	2000lm	3000K/4000K/6000K	>80	White	350 mm x 81 mm	332 mm
SL2106/40TC/C	240V	24W	2000lm	3000K/4000K/6000K	>80	White	350 mm x 81 mm	332 mm

\*FC = Fixing Centres



## SENSOR MODELS

- Integrated microwave motion sensor

Model No.	Detection Range	Daylight Threshold	Duration
SL2106/30TC/S	100%	Disabled	10 mins.
SL2106/30TC/S1	100%	50 Lux	10 mins.
SL2106/30TC/S2	50%	50 Lux	5 mins.



- Integrated microwave motion sensor with standBY function

Model No.	Detection Range	Daylight Threshold	Duration	Standby Level	Standby Period
SL2106/40TC/C	100%	Disabled	12 mins.	20%	30 mins.
SL2106/40TC/C1	100%	50 Lux	6 mins.	30%	30 mins.
SL2106/40TC/C2	100%	50 Lux	6 mins.	20%	24 hrs.



## PHOTOMETRIC DATA (AT CCT 4000K)

UNIT: cd C0/C180 — C90/C270

SL2106/20TC at 4000K

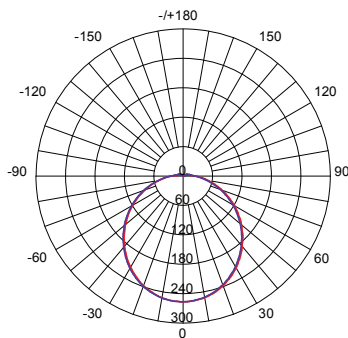

SL2106/30TC at 4000K

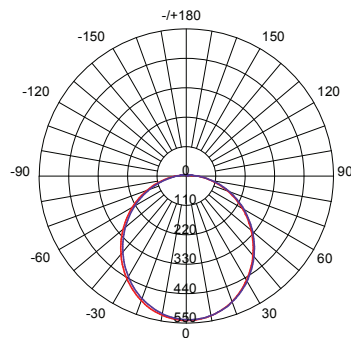

SL2106/40TC at 4000K

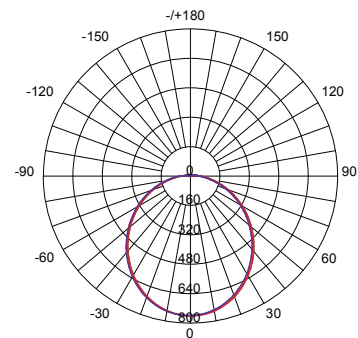



# LED OYSTER LIGHT

## SL2108 DISH I



### CONSTRUCTION

- Powder coated steel base
- Complete with white trim
- Opal acrylic diffuser
- High efficiency SMD LED chips
- Built-in constant current non-dimmable LED driver

### IP RATING

- IP44 weatherproof

### TRIM COLOUR OPTION

- Silver trim option available (SL2108SL/RING)



### DIMENSIONS

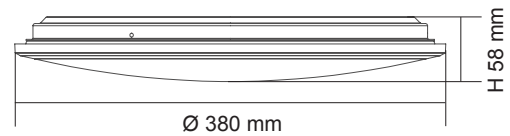

Model No.	Input	Power	Lumen	CCT	CRI
SL2108WW	240V	22W	1900lm	3000K	>80
SL2108DL	240V	22W	1900lm	5000K	>80

### PHOTOMETRIC DATA

UNIT: cd C0/C180 — C90/C270 —  
 SL2108WW SL2108DL

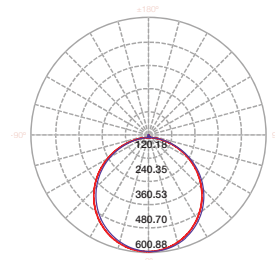
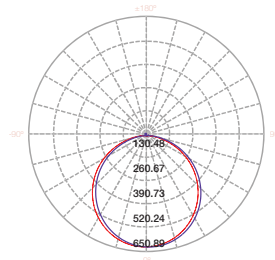

# LED OYSTER

## SO2107 PEARL

### CONSTRUCTION

- Powder coated steel base
- Opal polycarbonate diffuser
- Built-in E27 lampholders
- Lamps NOT included

### IP RATING

- IP44 weatherproof

### LAMP OPTIONS

- LG5, LG9
- LGS4, LGS8, LGS10, LGS14D
- LT407, LT409



### DIMENSIONS

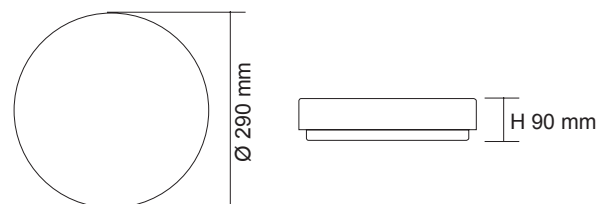

Model No.	Input	Lamp Base
SO2107	240V	E27 x 2



# DIMMABLE LED OYSTER LIGHT

## SL2111 DISCUS



### CONSTRUCTION

- Super slim disc shaped polycarbonate body
- Simple twist lock installation mechanism
- Opal acrylic diffuser
- High efficiency SMD LED chips
- Built-in constant current trailing edge dimmable LED driver

### IP RATING

- IP40 suitable for interior use only

### FITTING COLOUR

- Silver (standard)
- White (option)

### COLOUR TEMPERATURE

- 4000K Cool White (standard)
- 3000K Warm White (option)
- 5700K Daylight (option)



### DIMENSIONS

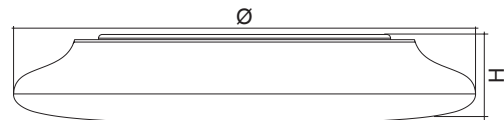

Model No.	Input	Power	Lumen	CCT	CRI	Fitting Colour	Dimensions Ø x H
SL2111/25CW/SL	240V	12W	1180lm	4000K	>80	Silver	250 x 48 mm
SL2111/30CW/SL	240V	18W	1700lm	4000K	>80	Silver	300 x 48 mm
SL2111/40CW/SL	240V	25W	2300lm	4000K	>80	Silver	400 x 63mm

### PHOTOMETRIC DATA

UNIT: cd C0/C180 — C90/270 —

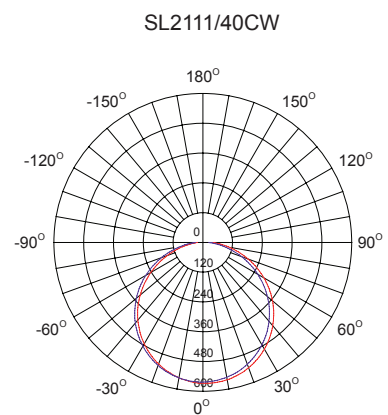
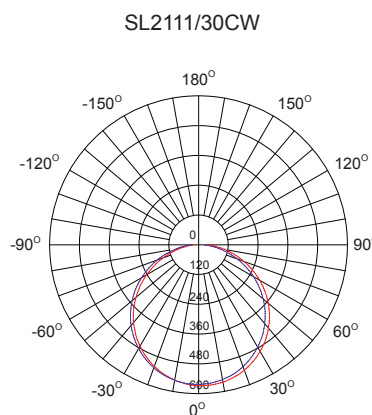
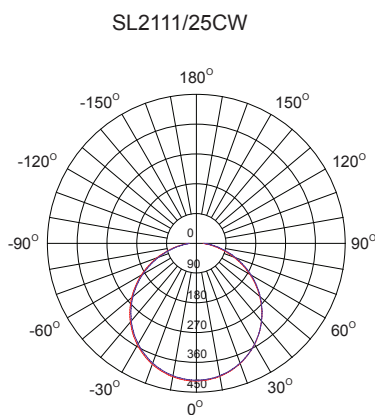

# LED OYSTER LIGHT

## SO2101 LED ALABASTER

### LED OYSTER

## SW2101, SO2101/30, SO2101/40 ALABASTER



### DIMENSIONS

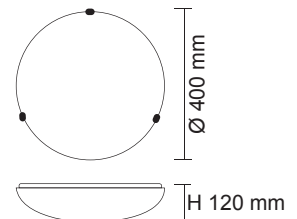
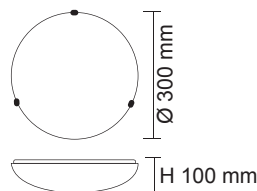
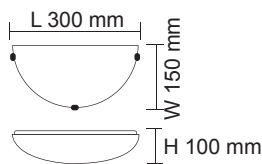

### CONSTRUCTION

- Powder coated steel base
- Die-cast clips with various colours
- Alabaster glass diffuser
- Built-in E27 lampholder(s) or LED conversion kit
- Lamps NOT included

### IP RATING

- IP20 suitable for interior use only

### LAMP OPTIONS

- LG5, LG9
- LGS4, LGS8, LGS10, LGS14D
- LT407, LT409

Model No.	Input	Power	Lumen	CCT	CRI
SO2101/30 LED	240V	12W	1200lm	3000K / 4000K / 6000K	>80
SO2101/40 LED	240V	20W	1800lm	3000K / 4000K / 6000K	>80

Model No.	Input	Clips Colour	Lamp Base
SW2101 WH	240V	White	E27
SW2101 SC	240V	Satin Chrome	E27
SW2101 GD	240V	Gold	E27
SW2101 CH	240V	Chrome	E27
SW2101 AB	240V	Antique Brass	E27

Model No.	Input	Clips Colour	Lamp Base
SO2101/30 WH	240V	White	E27
SO2101/30 SC	240V	Satin Chrome	E27
SO2101/30 GD	240V	Gold	E27
SO2101/30 CH	240V	Chrome	E27
SO2101/30 AB	240V	Antique Brass	E27

### CLIP COLOURS



Model No.	Input	Clips Colour	Lamp Base
SO2101/40 WH	240V	White	E27 x 2
SO2101/40 SC	240V	Satin Chrome	E27 x 2
SO2101/40 GD	240V	Gold	E27 x 2
SO2101/40 CH	240V	Chrome	E27 x 2
SO2101/40 AB	240V	Antique Brass	E27 x 2

# LED OYSTER LIGHT

## SO3109 LED SOLAR

### LED OYSTER

## SW3109, SO3109/30, SO3109/40 SOLAR



### DIMENSIONS

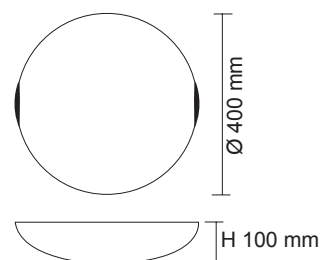
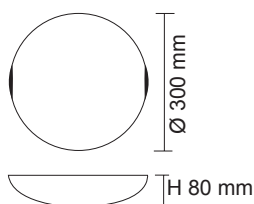
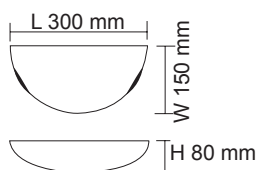

### CONSTRUCTION

- Powder coated steel base
- Satin Nickel plated clips
- Frosted glass diffuser
- Built-in E27 lampholder(s) or LED conversion kit
- Lamps NOT included

### IP RATING

- IP20 suitable for interior use only

### LAMP OPTIONS

- LG5, LG9
- LGS4, LGS8, LGS10, LGS14D
- LT407, LT409

Model No.	Input	Power	Lumen	CCT	CRI
SO3109/30 LED	240V	12W	1200lm	3000K / 4000K / 6000K	>80
SO3109/40 LED	240V	20W	1800lm	3000K / 4000K / 6000K	>80

Model No.	Input	Clips Colour	Lamp Base
SW3109	240V	Satin Nickel	E27
SO3109/30	240V	Satin Nickel	E27
SO3109/40	240V	Satin Nickel	E27 x 2

# DIMMABLE LED CEILING LIGHT

## SO3000 HALO



### CONSTRUCTION

- Slim disc like appearance
- Polycarbonate body
- Simple twist lock installation mechanism
- Opal acrylic diffuser
- High efficiency SMD LED chips
- Built-in constant current trailing edge dimmable LED driver

### IP RATING

- IP20 suitable for interior use only

### TRIM COLOUR

- Black (standard)
- Silver (option)

### COLOUR TEMPERATURE

- 4000K Cool White (standard)
- 3000K Warm White (option)
- 5700K Daylight (option)



### DIMENSIONS

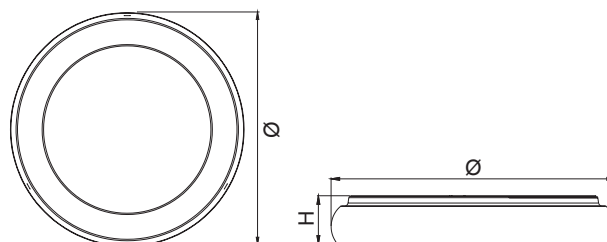

Model No.	Input	Power	Lumen	CCT	CRI	Fitting Colour	Dimensions Ø x H
SO3000/30CW	240V	18W	1450lm	4000K	>80	Black	300 x 51 mm
SO3000/40CW	240V	35W	3300lm	4000K	>80	Black	400 x 68 mm

### PHOTOMETRIC DATA UNIT: cd C0/C180 — C90/270 —

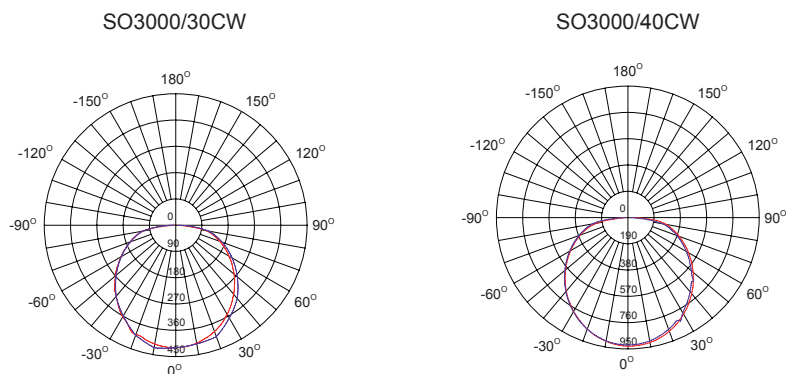



# DIMMABLE LED PENDANT LIGHT

## SPL3000 HALO



### CONSTRUCTION

- Slim disc like appearance
- Polycarbonate body
- Opal acrylic diffuser
- High efficiency SMD LED chips
- Built-in constant current trailing edge dimmable LED driver
- Suspension kits provided (standard length 1.5 m and adjustable)

### IP RATING

- IP20 suitable for interior use only

### TRIM COLOUR

- Black (standard)
- Silver (option)

### COLOUR TEMPERATURE

- 4000K Cool White (standard)
- 3000K Warm White (option)
- 5700K Daylight (option)

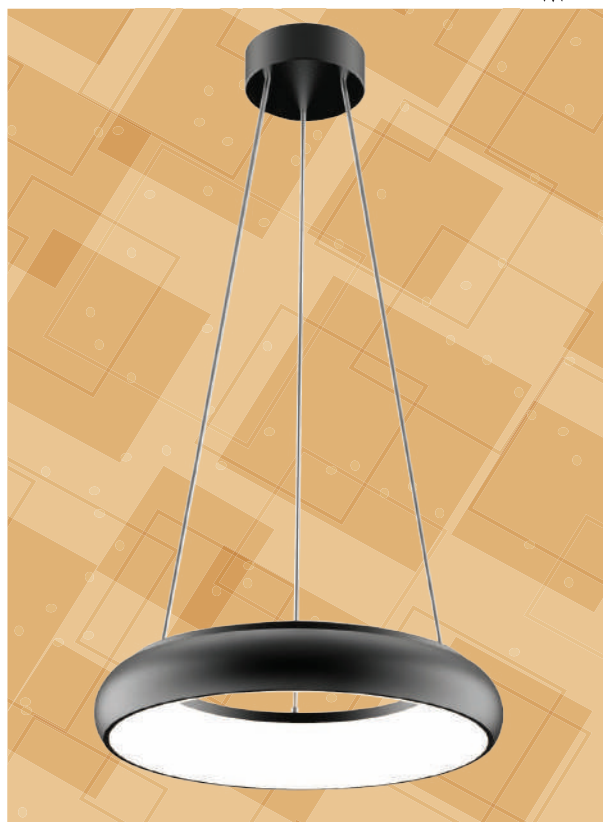

### DIMENSIONS

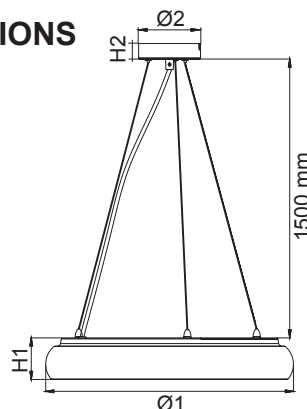

Model No.	Input	Power	Lumen	CCT	CRI	Fitting Colour	Dimensions Ø1 x H1, Ø2 x H2
SPL3000/30CW	240V	18W	1450lm	4000K	>80	Black	300 x 51, 100 x 25 mm
SPL3000/40CW	240V	35W	3300lm	4000K	>80	Black	400 x 68, 130 x 35 mm

### PHOTOMETRIC DATA

UNIT: cd C0/C180 ——— C90/270 ———

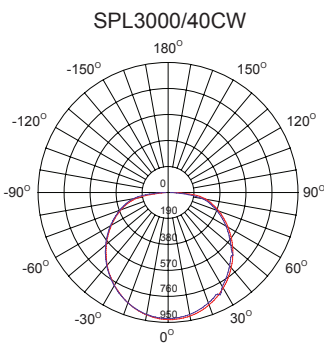
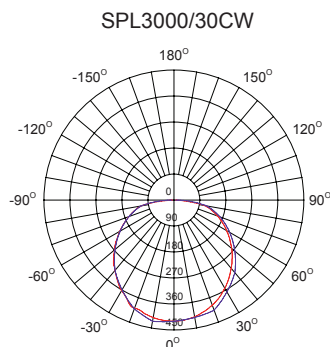

Specifications above are for reference only and may vary without prior notice



Dimmer/Switch Compatible



www.sal.net.au

# DIMMABLE LED OYSTER LIGHT

## SL2110 FLAT



### DIMENSIONS

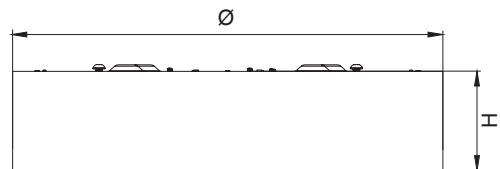
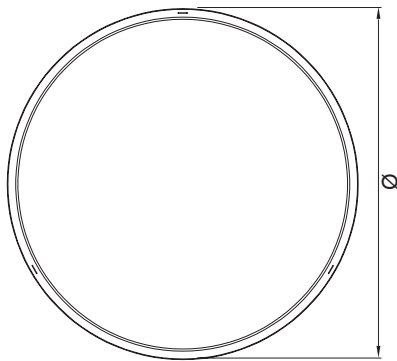

### CONSTRUCTION

- Seamless surface mounting base
- Polycarbonate diffuser
- Simple twist lock installation mechanism
- Constant current trailing edge dimmable LED driver fitted

### IP RATING

- IP20 suitable for interior use only

### COLOUR TEMPERATURE

- 4000K Cool White (standard)
- 3000K Warm White (option)
- 6000K Daylight (option)

### DIMMING OPTIONS

- DALI / DSI, digital (SL2110/30 & SL2110/40 only)

### INSTALLATION OPTION

- SL2110/30, SL2110/40, SL2110/50:  
suspension kits provided (standard length  
1.5 m and adjustable)



\*Image shown with suspension kit

Model No.	Input	Power	Lumen	CCT	CRI	Fitting Colour	Dimensions Ø x H
SL2110/10CW	240V	5W	180lm	4000K	>80	White	100 x 50 mm
SL2110/20CW	240V	12W	780lm	4000K	>80	White	160 x 50 mm
SL2110/30CW	240V	18W	1200lm	4000K	>80	White	260 x 60 mm
SL2110/40CW	240V	30W	2300lm	4000K	>80	White	350 x 60 mm
SL2110/50CW	240V	40W	3200lm	4000K	>80	White	480 x 60 mm

**PHOTOMETRIC DATA** UNIT: cd C0/C180

SL2110/20CW

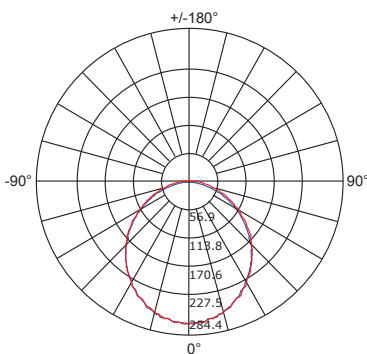

SL2110/30CW

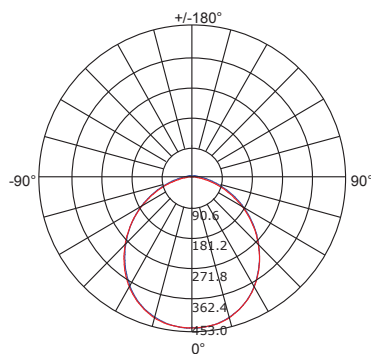

SL2110/40CW

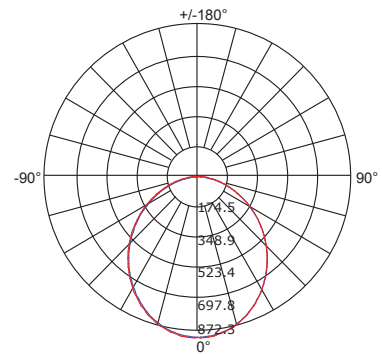

Specifications above are for reference only and may vary without prior notice



# LED OYSTER LIGHT

## SO3160 SHELL

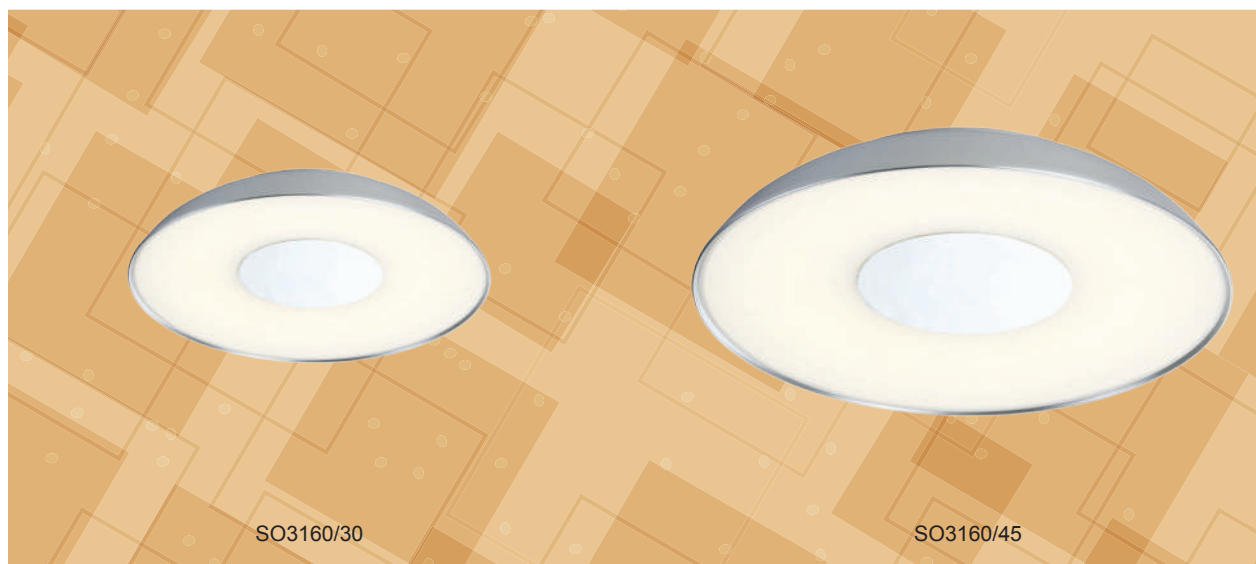

### DIMENSIONS

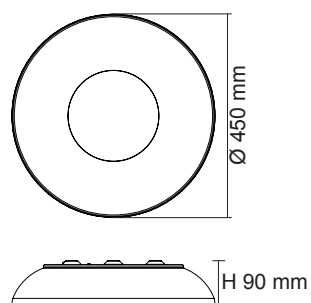
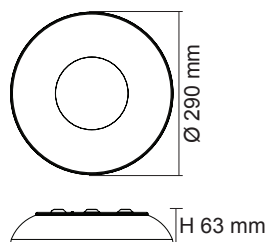

### CONSTRUCTION

- Premier aluminium housing
- Chrome plated centre locking disc
- Opal acrylic diffuser
- High efficiency SMD LED chips
- Built-in constant current non-dimmable LED driver

### IP RATING

- IP20 suitable for interior use only

Model No.	Input	Power	Lumen	CCT	Beam Angle	CRI	Fitting Colour	Dimensions Ø x H
SO3160/30	240V	14W	900lm	3000K	90°	>80	Anodized Silver	290 x 63 mm
SO3160/45	240V	30W	1800lm	3000K	90°	>80	Anodized Silver	450 x 90 mm

# LED CEILING LIGHT

## SL3147 FLORIO

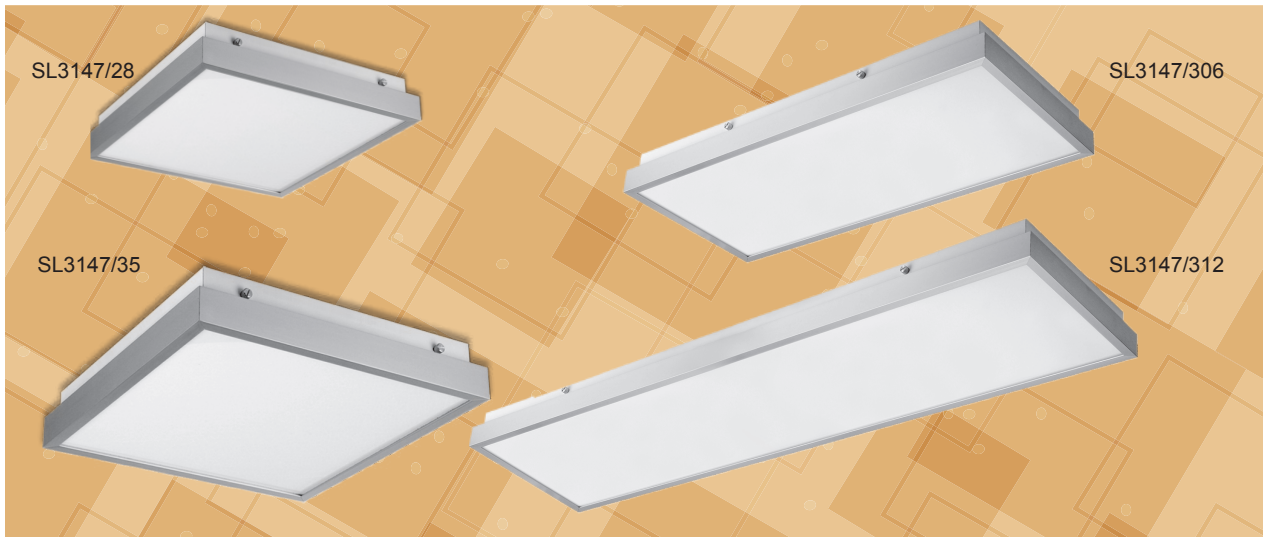

### DIMENSIONS

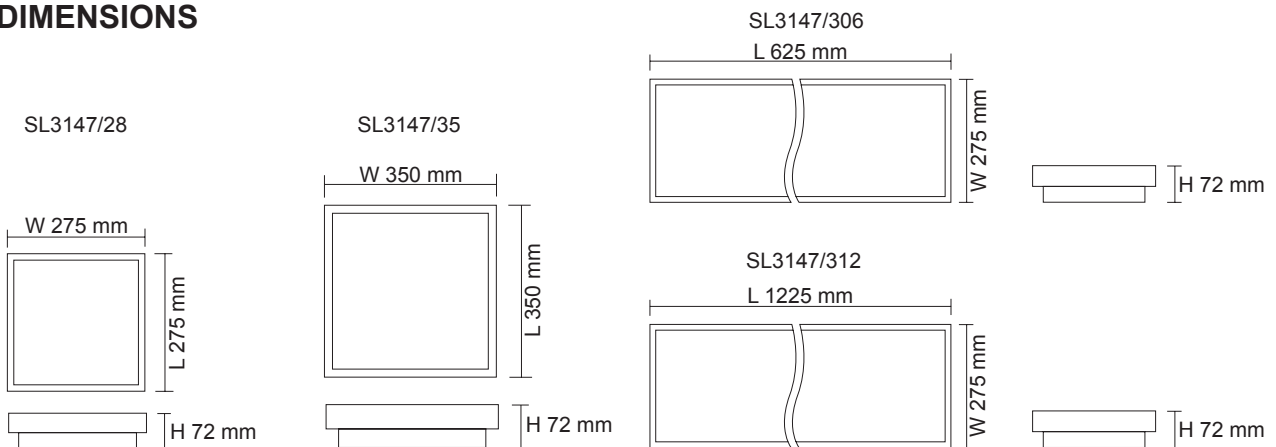

### CONSTRUCTION

- Extruded aluminium frame
- Powder coated steel base
- Opal polystyrene diffuser
- High efficiency SMD LED chips
- Constant current non-dimmable LED driver fitted

### IP RATING

- IP20 suitable for interior use only

### SENSOR OPTION

- Integrated microwave motion sensor
- Integrated microwave motion sensor with standBY function

### DIMMING OPTIONS

- Trailing edge (excluding SL3147/312)
- 1-10V analogue
- DALI / DSI, digital

### INSTALLATION OPTION (SL3147/306, SL3147/312)

- Surface mounted
- Suspension unit required (SSI1512 or SSY1512)

Model No.	Input	Power	Lumen	CCT	Beam Angle	CRI	Fitting Colour	Dimensions L x W X H
SL3147/28CW	240V	14W	900lm	4000K	110°	>80	Anodized Silver	275 x 275 X 72 mm
SL3147/35CW	240V	22W	1500lm	4000K	110°	>80	Anodized Silver	350 x 350 X 72 mm
SL3147/306 CW	240V	21W	1400lm	4000K	110°	>80	Anodized Silver	625 x 275 X 72 mm
SL3147/312 CW	240V	41W	2800lm	4000K	110°	>80	Anodized Silver	1225 x 275 X 72 mm

# LED PENDANT LIGHT SPL015 INDUSTRIAL

## CONSTRUCTION

- Extruded aluminium body
- Frosted glass diffuser
- High output LED chips
- Built-in constant current non-dimmable LED driver

## IP RATING

- IP20 suitable for interior use only

## DIMENSIONS

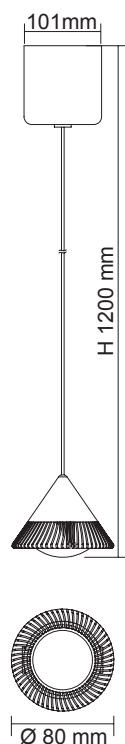

Model No.	Input	Power	Lumen	CCT	Beam Angle	CRI	Fitting Colour
SPL015	240V	12W	700lm	3000K	60°	>80	Anodized Silver



# LED PENDANT LIGHT

## SPL016 URBAN

### CONSTRUCTION

- Extruded aluminium body with glass housing
- Multi-glass lens
- High output LED chips
- Built-in constant current non-dimmable LED driver

### IP RATING

- IP20 suitable for interior use only

### DIMENSIONS

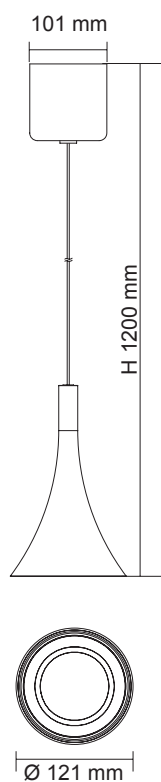

Model No.	Input	Power	Lumen	CCT	Beam Angle	CRI	Fitting Colour
SPL016	240V	9W	500lm	3000K	15°	>80	Anodized Silver

Specifications above are for reference only and may vary without prior notice



# LED PENDANT LIGHT

## SPL018 CHIC

### CONSTRUCTION

- Extruded aluminium body with glass housing
- Frosted glass diffuser
- High output LED chips
- Built-in constant current non-dimmable LED driver

### IP RATING

- IP20 suitable for interior use only

### DIMENSIONS

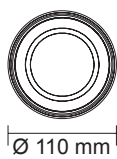
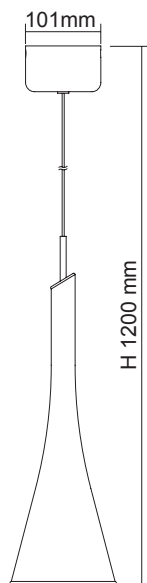

Model No.	Input	Power	Lumen	CCT	Beam Angle	CRI	Fitting Colour
SPL018	240V	20W	1000lm	3000K	75°	>80	Anodized Silver

# LED PENDANT LIGHT

## SPL019 DROP

### CONSTRUCTION

- Aluminium body
- Opal acrylic diffuser
- High output LED chips
- Built-in constant current non-dimmable LED driver

### IP RATING

- IP20 suitable for interior use only

### DIMENSIONS

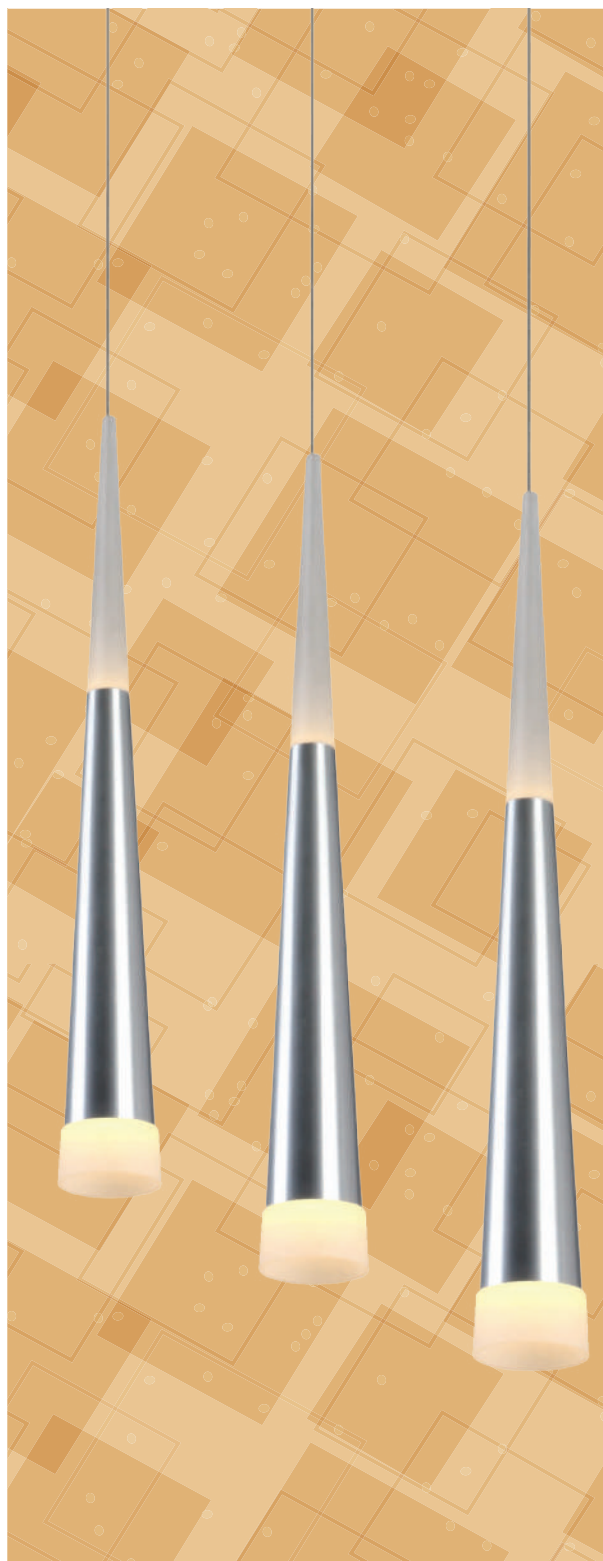
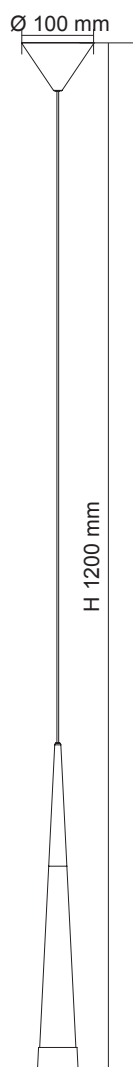

Model No.	Input	Power	Lumen	CCT	Beam Angle	CRI	Fitting Colour
SPL019	240V	6.5W	350lm	3000K	60°	>80	Anodized Silver

Specifications above are for reference only and may vary without prior notice



# LED PENDANT LIGHT

## SPL020 PIP

### CONSTRUCTION

- Ultra Slimline suspended tube profile
- Ultra slim recessed ceiling plate to suit standard 72 mm cut out
- Die-cast aluminium body
- High efficiency COB LED chip
- Recessed downlight mounting installation
- Standard adjustable wire length up to 1.2 m
- Built-in constant current non-dimmable LED driver

### IP RATING

- IP20 suitable for interior use only

### FITTING COLOUR

- White (standard)
- Black (option)

### BEAM ANGLE

- 25° (standard)
- 10°, 40° optical reflector (option)

### COLOUR TEMPERATURE

- 3000K Warm White (standard)
- 4000K Cool White (option)
- 6000K Daylight (option)

### DIMENSIONS

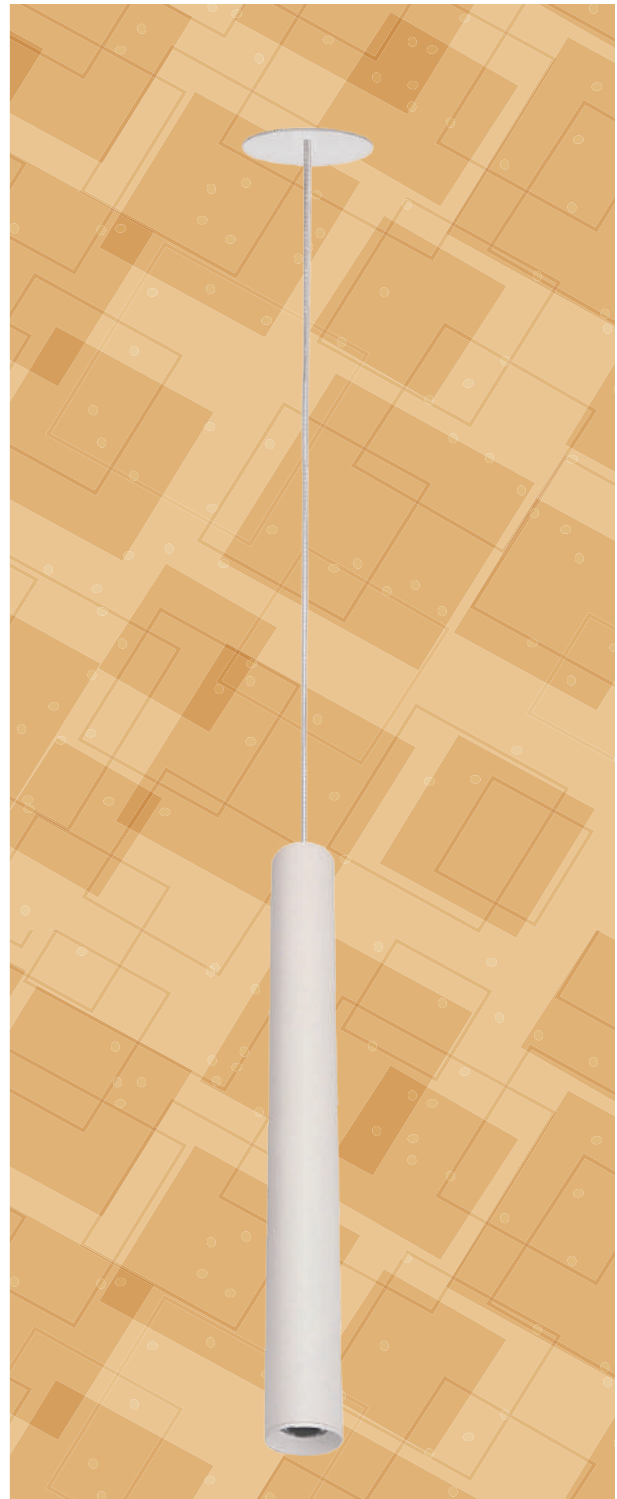
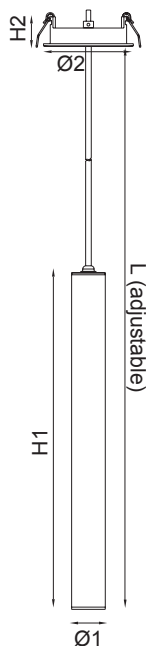

Model No.	Input	Power	Lumen	CCT	Beam Angle	CRI	Cut Out Ø	Dimension Ø1 x H1, Ø2 x H2
SPL020WW30	240V	5W	160lm	3000K	25°	>80	72 mm	30 x 300 mm, 80 x 26 mm
SPL020WW45	240V	5W	160lm	3000K	25°	>80	72 mm	30 x 450 mm, 80 x 26 mm

# DIMMABLE LED PENDANT LIGHT

## SPL9017 UNITREK



### CONSTRUCTION

- Architectural cylindrical profile
- Die-cast aluminium body
- High efficiency COB LED chip
- Changeable multi-reflector system
- Polycarbonate optical lens
- Built-in constant current trailing edge dimmable LED driver
- Standard adjustable wire length up to 1.2 m

### IP RATING

- IP20 suitable for interior use only

### FITTING COLOUR

- White (standard)
- Black (option)

### BEAM ANGLE

- 60° (standard)
- 25°, 40° optical reflector (option)

### DIMENSIONS

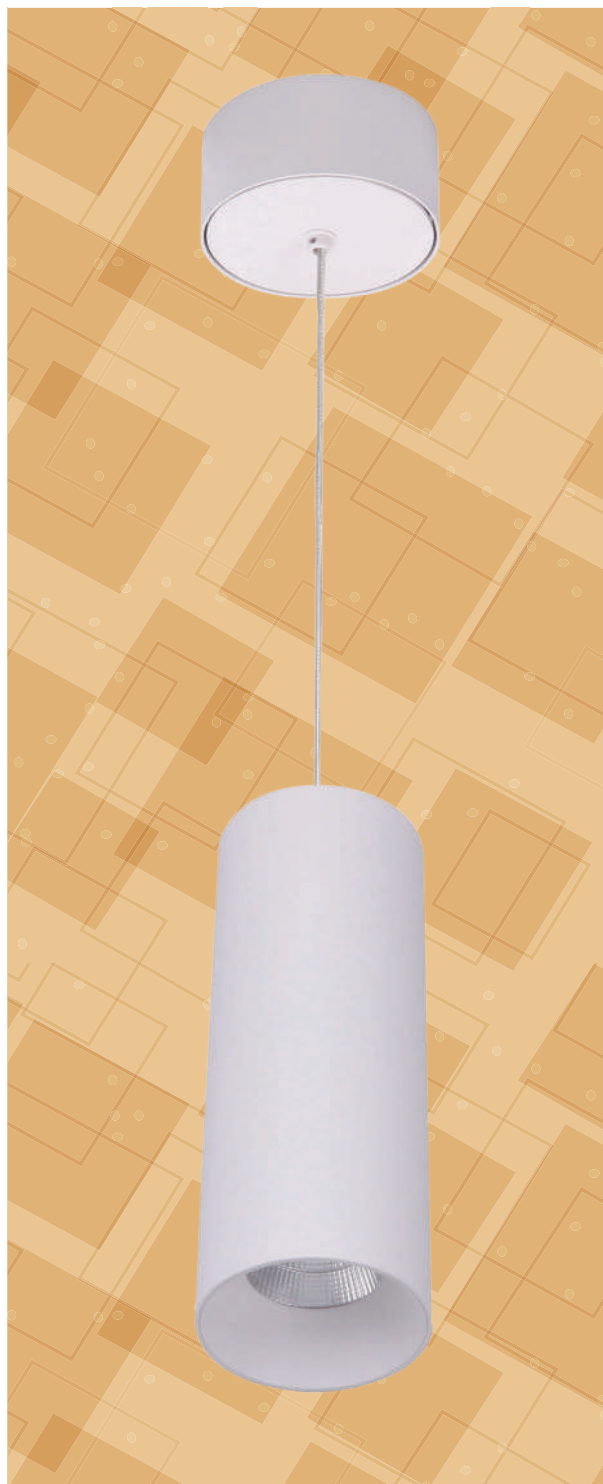
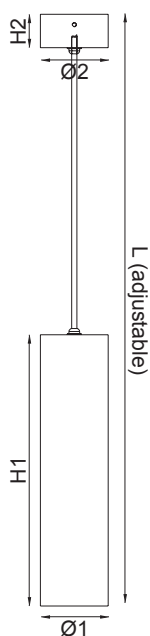

Model No.	Input	Power	Lumen	CCT	Beam Angle	CRI	Dimension Ø1 x H1, Ø2 x H2
SPL9017WW/WH	240V	9W	700lm	3000K	60°	>80	65 x 260, 65 x 32 mm
SPL9017CW/WH	240V	9W	800lm	4000K	60°	>80	65 x 260, 65 x 32 mm
SPL9017DL/WH	240V	9W	800lm	6000K	60°	>80	65 x 260, 65 x 32 mm

# LED PENDANT LIGHT

## SPL3200 RING

### CONSTRUCTION

- Aluminium body
- Opal acrylic diffuser
- High efficiency SMD LED chips
- Constant current non-dimmable LED driver fitted

### IP RATING

- IP20 suitable for interior use only

### DIMMING OPTIONS

- Trailing edge (excluding SPL3200/81, SPL3200/2R)

### DIMENSIONS

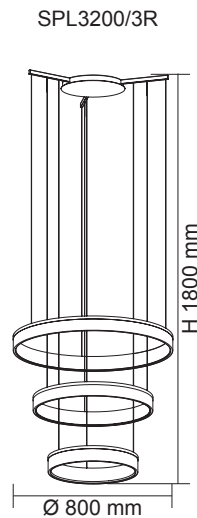
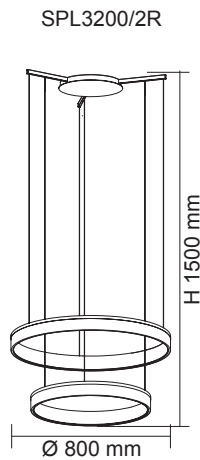
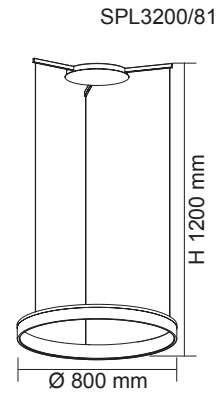
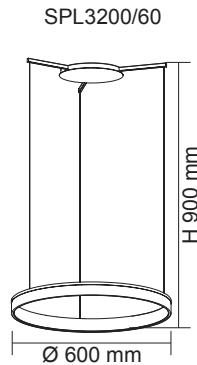
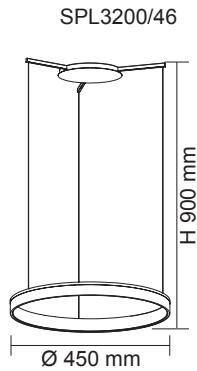

Model No.	Input	Power	Lumen	CCT	CRI	Fitting Colour
SPL3200/46	240V	17W	900lm	3000K	>80	Black
SPL3200/60	240V	23W	1200lm	3000K	>80	Black
SPL3200/81	240V	30W	1500lm	3000K	>80	Black
SPL3200/2R	240V	53W	2700lm	3000K	>80	Black
SPL3200/3R	240V	70W	3600lm	3000K	>80	Black



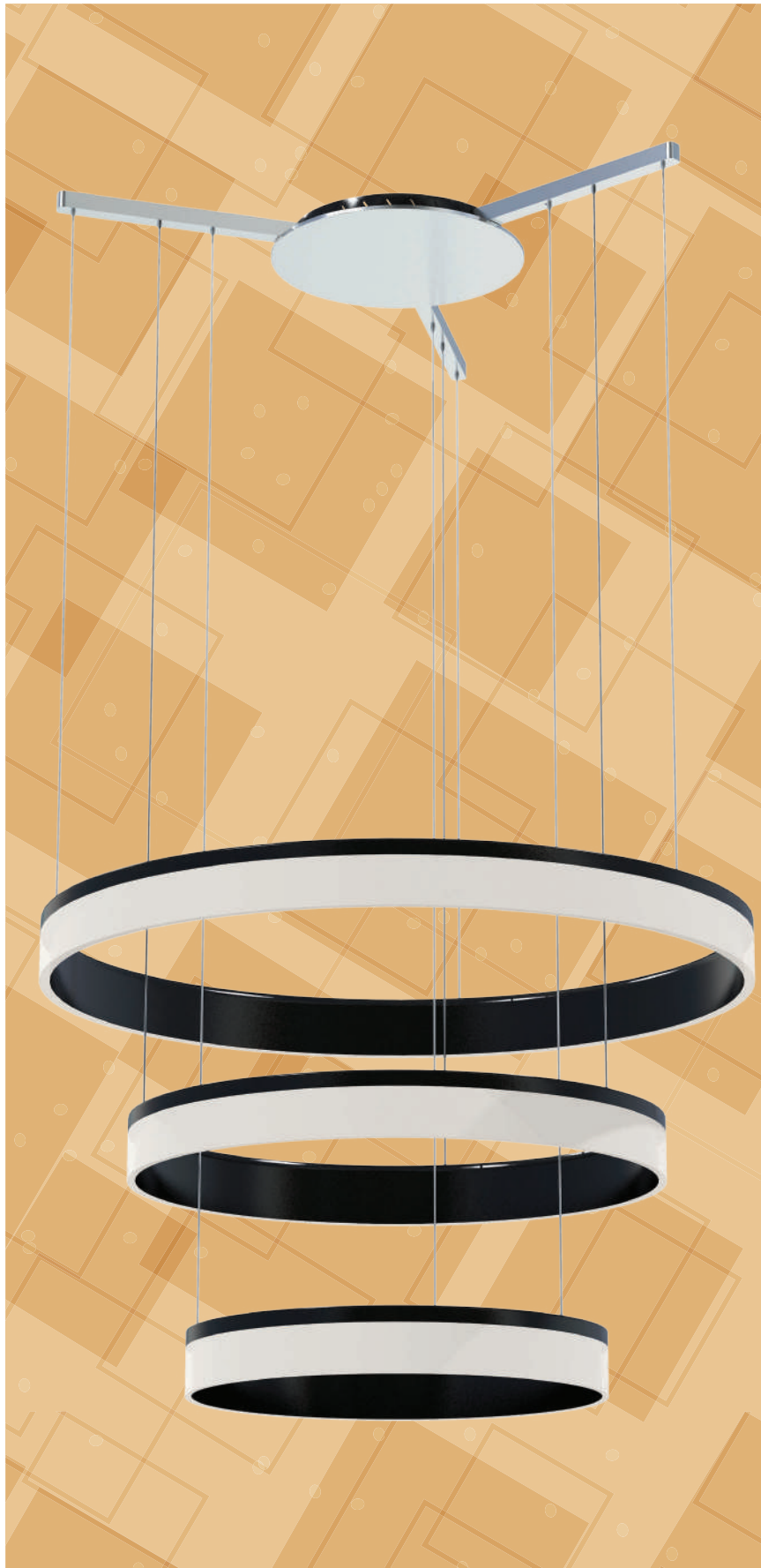

Specifications above are for reference only and may vary without prior notice



# LED PENDANT LIGHT

## SPL3100 CLASSIC RING

### CONSTRUCTION

- Polyurethane body
- Opal acrylic diffuser
- High efficiency SMD LED chips
- Built-in constant current non-dimmable LED driver

### IP RATING

- IP20 suitable for interior use only

### DIMENSIONS

SPL3100/64

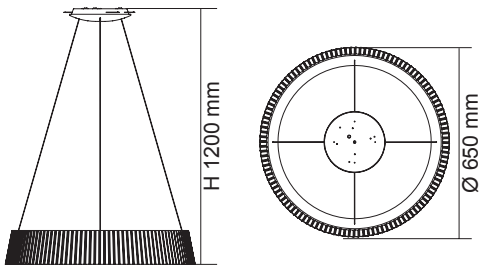

SPL3100/84

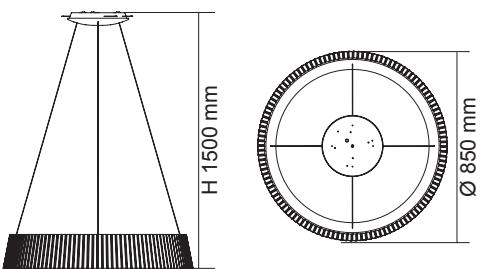

Model No.	Input	Power	Lumen	CCT	CRI	Fitting Colour
SPL3100/64	240V	45W	2250lm	3000K	>80	White
SPL3100/84	240V	67W	3300lm	3000K	>80	White

# DIMMABLE LED FLOOR LAMP

## SFL018 STAN



### CONSTRUCTION

- Black aluminium body with polycarbonate diffuser
- Powder coated finish
- Built-in constant current trailing edge dimmable LED driver
- Touch dimmable with a memory function
- Beam upwards
- Compact packaging, easy to assemble
- Supplied with a 2 pin plug-in driver & 1.5 m lead

### IP RATING

- IP20 suitable for interior use only

### DIMENSIONS

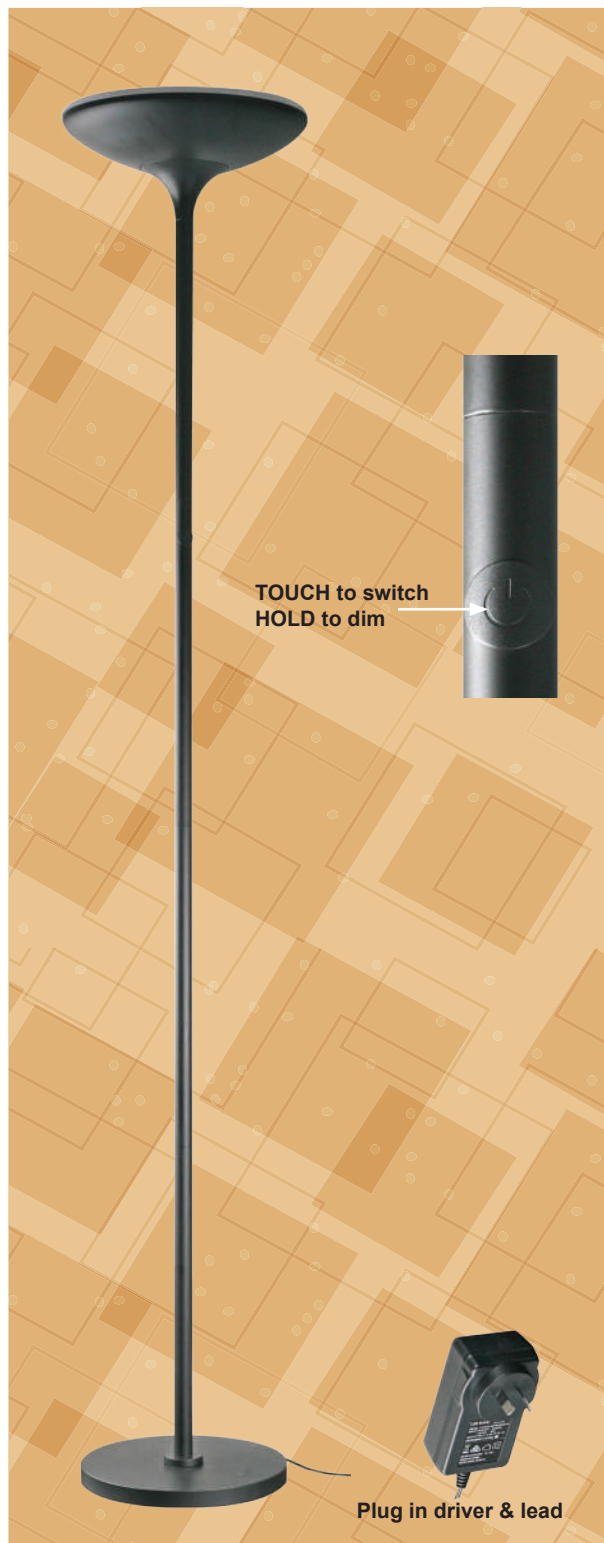
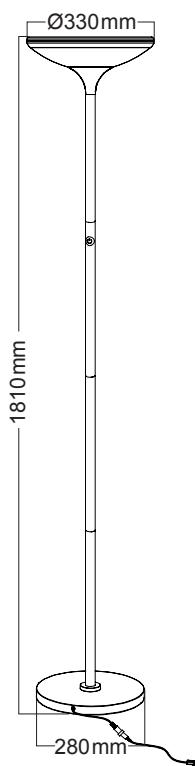

Model No.	Input	Power	Lumen	CCT	Beam Angle	CRI	Dimmable	Fitting Colour
SFL018WW	240V	43W	3000lm	3000K	120°	>80	Yes	Black



[www.sal.net.au](http://www.sal.net.au)

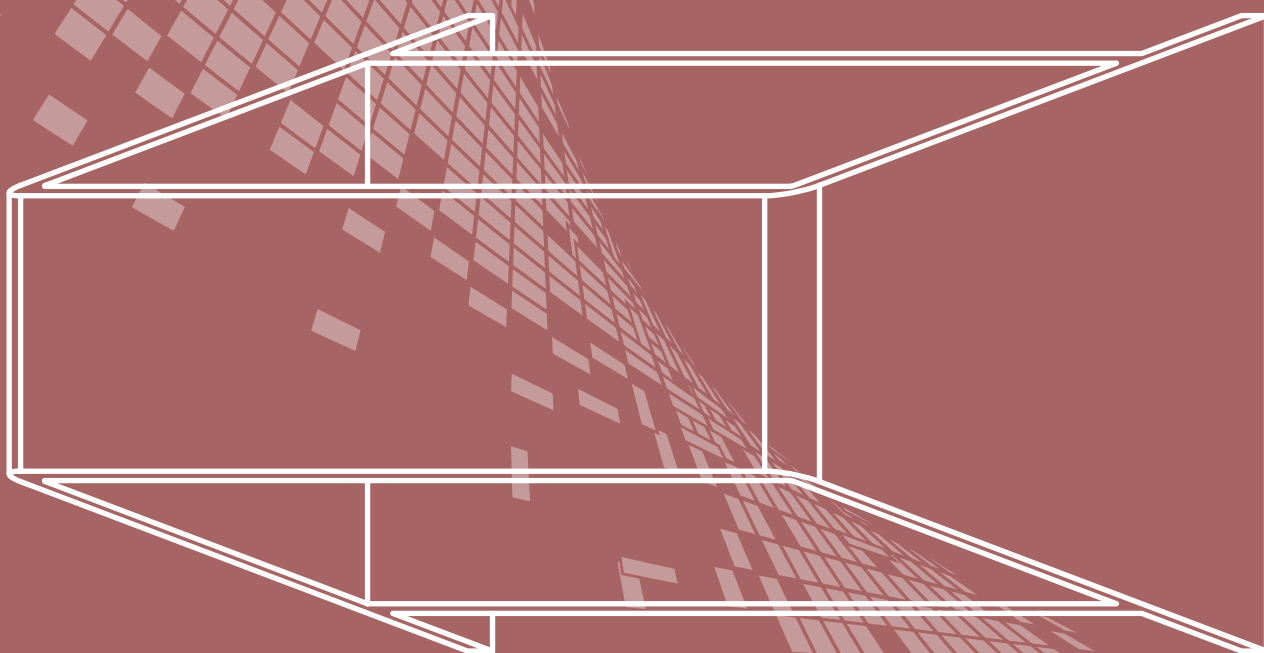

# LED CABINET & WALL LIGHTS

## NEW PRODUCTS



p101  
S9320 CUBE



p103  
S9356 UD



p107  
S9319 LEEMAN MINI

# LED CABINET LIGHT

## S9105, S9105 SR, S9105 ST ANOVA



### DIMENSIONS

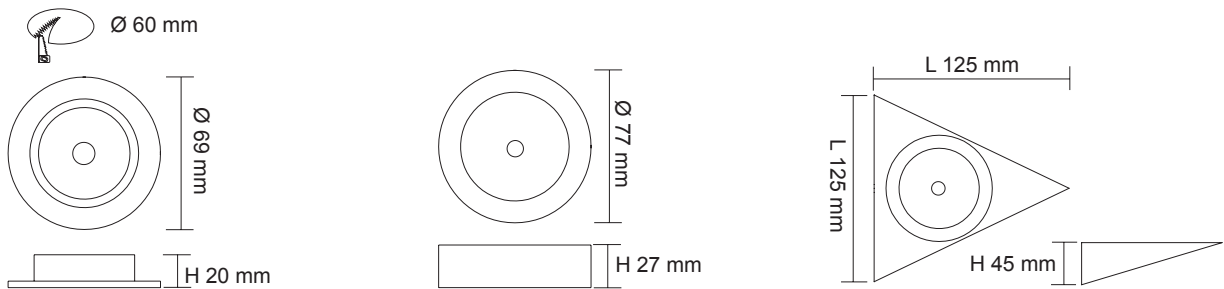

### CONSTRUCTION

- Die cast aluminium body
- Powder coated or plated finish
- High efficiency SMD LED chips
- 12V DC LED driver required

### IP RATING

- IP20 suitable for interior use only

### SUITABLE DRIVERS

- PLUTO EGL12V/6W
- PLUTO EGL12V/15W
- PLUTO 30/12V
- PLUTO 50/12V
- PLUTO 100/12V
- PLUTO 200/12V

Model No.	Input	Power	Lumen	CCT	Beam Angle	CRI	Dimmable	Installation Type	Fitting Colour
S9105WW/WH	12V DC	4W	280lm	3000K	90°	>82	No	Recessed	White
S9105DL/WH	12V DC	4W	280lm	6000K	90°	>82	No	Recessed	White
S9105WW/SN	12V DC	4W	280lm	3000K	90°	>82	No	Recessed	Satin Nickel
S9105DL/SN	12V DC	4W	280lm	6000K	90°	>82	No	Recessed	Satin Nickel

Model No.	Input	Power	Lumen	CCT	Beam Angle	CRI	Dimmable	Installation Type	Fitting Colour
S9105WW SR/WH	12V DC	4W	280lm	3000K	90°	>82	No	Surface Mounted	White
S9105DL SR/WH	12V DC	4W	280lm	6000K	90°	>82	No	Surface Mounted	White
S9105WW SR/SN	12V DC	4W	280lm	3000K	90°	>82	No	Surface Mounted	Satin Nickel
S9105DL SR/SN	12V DC	4W	280lm	6000K	90°	>82	No	Surface Mounted	Satin Nickel

Model No.	Input	Power	Lumen	CCT	Beam Angle	CRI	Dimmable	Installation Type	Fitting Colour
S9105WW ST/WH	12V DC	4W	280lm	3000K	90°	>82	No	Surface Mounted	White
S9105DL ST/WH	12V DC	4W	280lm	6000K	90°	>82	No	Surface Mounted	White
S9105WW ST/SN	12V DC	4W	280lm	3000K	90°	>82	No	Surface Mounted	Satin Nickel
S9105DL ST/SN	12V DC	4W	280lm	6000K	90°	>82	No	Surface Mounted	Satin Nickel



# LED SURFACE MOUNTED WALL LIGHT

## S9320 CUBE

### CONSTRUCTION

- Extruded aluminium body
- Powder coated finish
- High output LED chip
- Up & Down beam angle adjustable from 0° to 60°
- Built-in constant current non-dimmable LED driver

### IP RATING

- IP20 suitable for interior use only

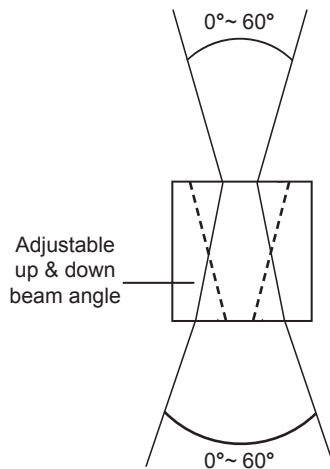

### DIMENSIONS

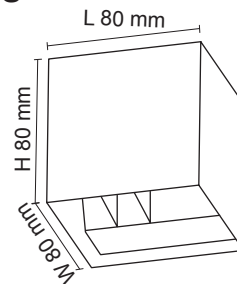

Model No.	Input	Power	Lumen	CCT	CRI	Fitting Colour
S9320	240V	2W	160lm	3000K	>80	White

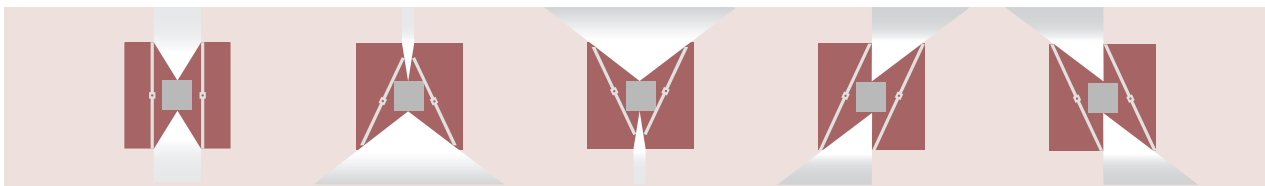

# LED SURFACE MOUNTED WALL LIGHT

## S9327, S9328 LOUNGE I & II



### DIMENSIONS

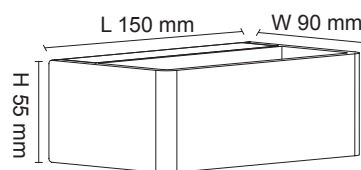
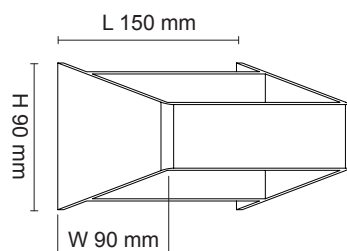

### CONSTRUCTION

- Extruded aluminium body
- Powder coated finish
- High output COB LED chip (S9327)
- High efficiency SMD LED chips (S9328)
- Built-in constant current LED driver
- Indirect illumination

### IP RATING

- IP20 suitable for interior use only

Model No.	Input	Power	Lumen	CCT	CRI	Fitting Colour
S9327	240V	4W	200lm	3000K	>80	White
S9328	240V	9W	450lm	3000K	>80	White

# LED SURFACE MOUNTED WALL LIGHT

## S9356 UD



### DIMENSIONS

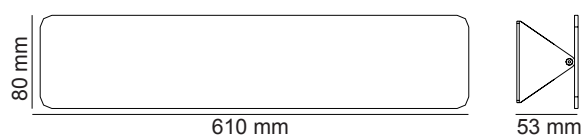

### CONSTRUCTION

- Extruded aluminium body
- Powder coated finish
- High efficiency SMD LED chips
- Up & Down beam angle adjustable from 0° to 120°
- Constant current LED driver fitted

### IP RATING

- IP20 suitable for interior use only

Model No.	Input	Power	Lumen	CCT	CRI	Fitting Colour
S9356/160WW/WH	240V	3W	250lm	3000K	>80	White
S9356/610WW/WH	240V	12W	800lm	3000K	>80	White

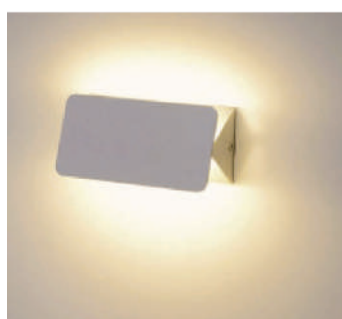
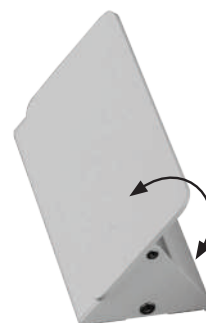
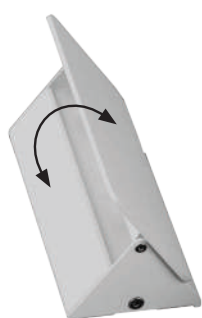

# LED RECESSED WALL LIGHT

## S9311 BROOM

### CONSTRUCTION

- Die cast aluminium body
- Powder coated finish (White)
- Opal acrylic diffuser
- High efficiency SMD LED chips
- 12V AC or DC driver required

### IP RATING

- IP20 suitable for interior use only

### SUITABLE DRIVERS

- PLUTO EGL12V/6W
- PLUTO EGL12V/15W
- PLUTO 30/12V
- PLUTO 50/12V
- PLUTO 100/12V
- PLUTO 200/12V



S9311 WH

### DIMENSIONS

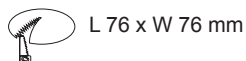

L 76 x W 76 mm

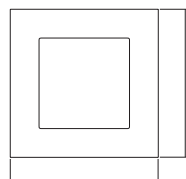

L 90 mm

W 90 mm

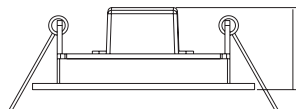

H 34 mm

Model No.	Input	Power	Lumen	CCT	Beam Angle	CRI	Fitting Colour
S9311 WH	12V	3W	110lm	3000K	105°	>80	White
S9311 SN	12V	3W	110lm	3000K	105°	>80	Satin Nickel

# LED RECESSED WALL LIGHT

## S9316, S9317 DARHAM

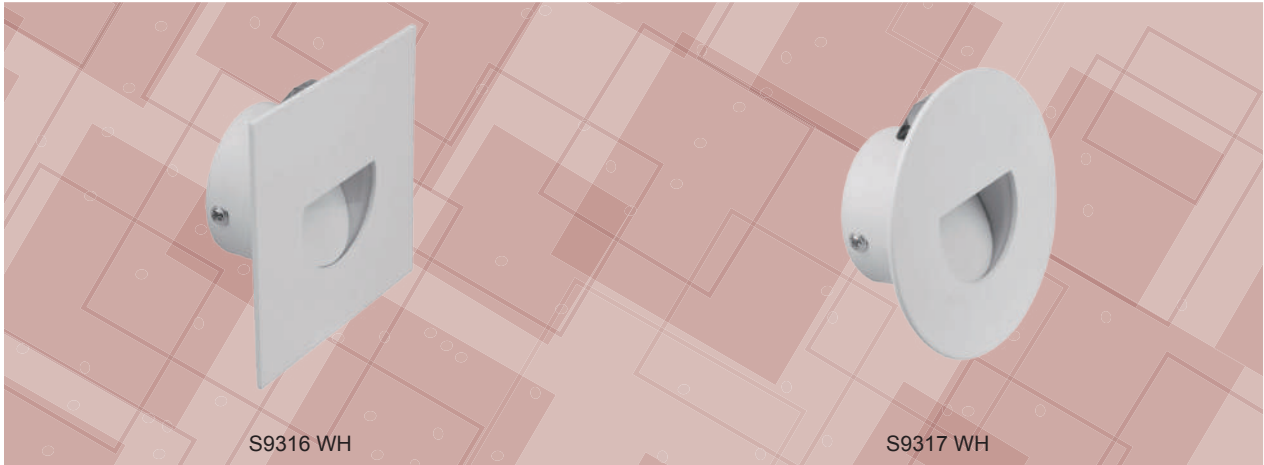

### DIMENSIONS

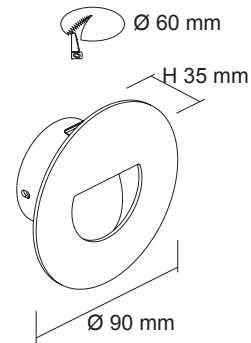
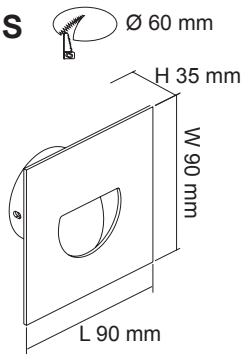

### CONSTRUCTION

- Die-cast aluminium body
- Powder coated finish
- Aluminium reflector
- Opal acrylic diffuser with front glass cover
- High efficiency SMD LED chips
- 12V AC or DC driver required

### SUITABLE DRIVERS

- PLUTO EGL12V/6W
- PLUTO EGL12V/15W
- PLUTO 30/12V
- PLUTO 50/12V
- PLUTO 100/12V
- PLUTO 200/12V

### IP RATING

- IP20 suitable for interior use only

Model No.	Input	Power	Lumen	CCT	CRI	Fitting Colour
S9316 WH	12V	1.5W	110lm	3000K	>80	White
S9316 ALU	12V	1.5W	110lm	3000K	>80	Anodized Silver
S9317 WH	12V	1.5W	110lm	3000K	>80	White
S9317 ALU	12V	1.5W	110lm	3000K	>80	Anodized Silver

### OPTIONAL ACCESSORIES

#### PRE-INSTALL BOX (S9316 ONLY)

- L x W x H: 218 x 133 x 74 mm

Model No.	Description
S9316/8 BOX	Concrete box for S9316/S9318

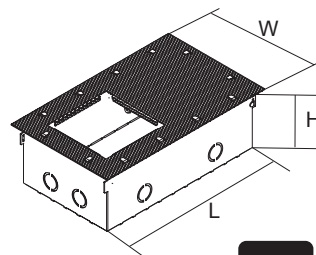

# LED RECESSED WALL LIGHT

## S9318 LEE MAN

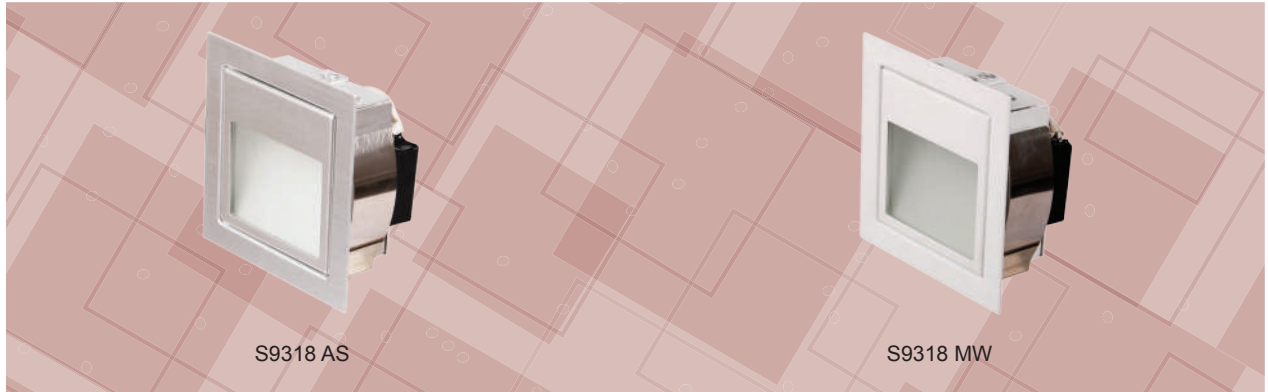

### DIMENSIONS

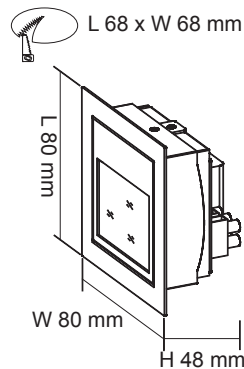

### CONSTRUCTION

- Die-cast aluminium body
- Powder coated finish (S9318 MW)
- Frosted glass diffuser
- High efficiency SMD LED chips
- 12V AC or DC driver required

### SUITABLE DRIVERS

- PLUTO EGL12V/6W
- PLUTO EGL12V/15W
- PLUTO 30/12V
- PLUTO 50/12V
- PLUTO 100/12V
- PLUTO 200/12V

### IP RATING

- IP20 suitable for interior use only

Model No.	Input	Power	Lumen	CCT	Beam Angle	CRI	Fitting Colour
S9318 AS	12V	1.5W	70lm	3000K	86°	>80	Anodized Silver
S9318 MW	12V	1.5W	70lm	3000K	86°	>80	Matt White

### OPTIONAL ACCESSORIES

#### PRE-INSTALL BOX

- L x W x H: 218 x 133 x 74 mm

Model No.	Description
S9316/8 BOX	Concrete box for S9316/S9318

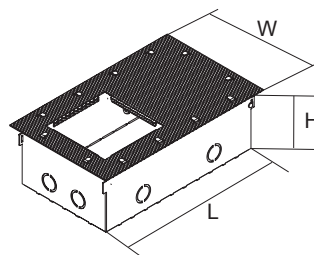



# LED RECESSED WALL LIGHT

## S9319 LEEMAN MINI

### CONSTRUCTION

- Die-cast aluminium body
- Powder coated finish (Matt White)
- Frosted glass diffuser
- High efficiency SMD LED chips
- 12V AC or DC driver required

### IP RATING

- IP20 suitable for interior use only

### SUITABLE DRIVERS

- PLUTO EGL12V/6W
- PLUTO EGL12V/15W
- PLUTO 30/12V
- PLUTO 50/12V
- PLUTO 100/12V
- PLUTO 200/12V

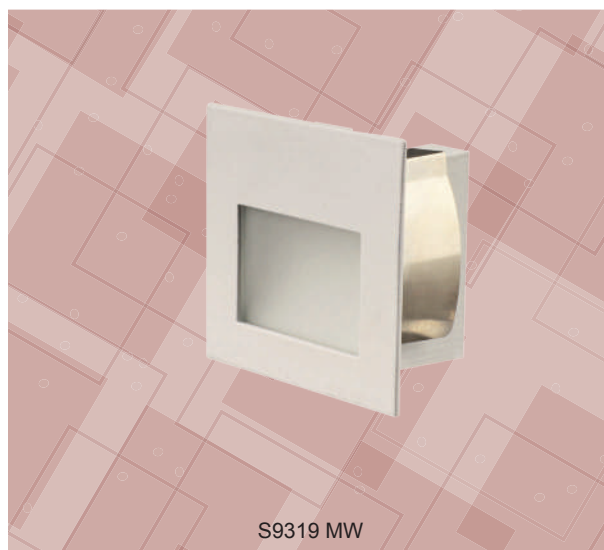

### DIMENSIONS

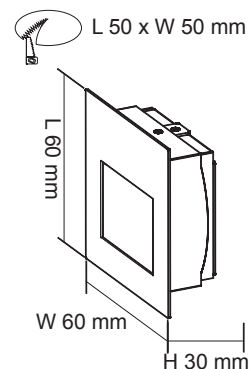

Model No.	Input	Power	Lumen	CCT	Beam Angle	CRI	Fitting Colour
S9319 AS	12V	1.5W	70lm	3000K	86°	>80	Anodized Silver
S9319 MW	12V	1.5W	70lm	3000K	86°	>80	Matt White

# LED RECESSED WALL LIGHT

## S9511/LED, S9512/LED DESERT



### DIMENSIONS

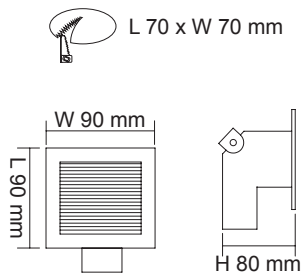

### DIMENSIONS

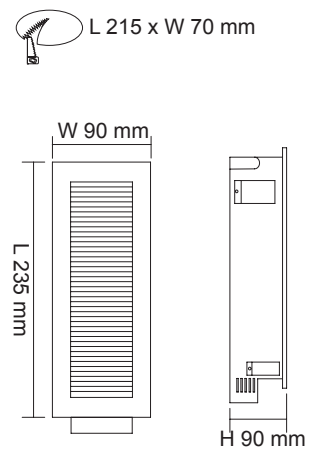

### CONSTRUCTION

- Pressed steel casing
- Powder coated finish (White)
- Aluminium reflector
- High efficiency SMD LED chips
- 12V AC or DC LED driver required

### IP RATING

- IP20 suitable for interior use only

### SUITABLE DRIVERS

- PLUTO EGL12V/6W
- PLUTO EGL12V/15W
- PLUTO 30/12V
- PLUTO 50/12V
- PLUTO 100/12V
- PLUTO 200/12V

Model No.	Input	Power	Lumen	CCT	CRI	Fitting Colour
S9511/LED/SL	12V	3W	110lm	3000K	>80	Silver
S9511/LED/WH	12V	3W	110lm	3000K	>80	White
S9512/LED/SL	12V	3W	110lm	3000K	>80	Silver
S9512/LED/WH	12V	3W	110lm	3000K	>80	White

# LED RECESSED WALL LIGHT

## S9515 BEACON

### CONSTRUCTION

- Pressed steel body
- Powder coated finish (White)
- Aluminium reflector
- Adjustable hood 5°~85°
- High efficiency SMD LED chips
- 12V AC or DC LED driver required

### IP RATING

- IP20 suitable for interior use only

### SUITABLE DRIVERS

- PLUTO EGL12V/6W
- PLUTO EGL12V/15W
- PLUTO 30/12V
- PLUTO 50/12V
- PLUTO 100/12V
- PLUTO 200/12V



### DIMENSIONS

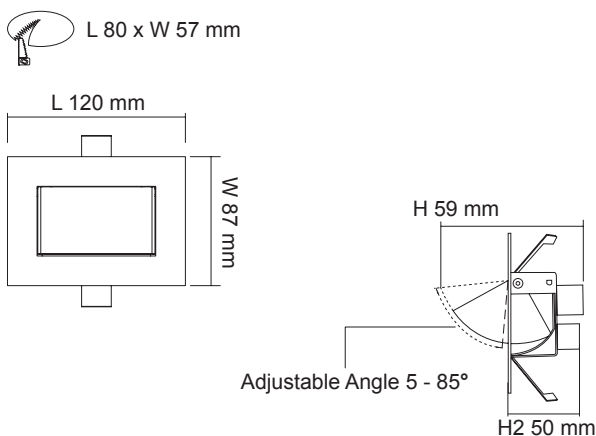

Model No.	Input	Power	Lumen	CCT	CRI	Fitting Colour
S9515 LED WH	12V	3W	110lm	3000K	>80	White
S9515 LED SN	12V	3W	110lm	3000K	>80	Satin Nickel



[www.sal.net.au](http://www.sal.net.au)

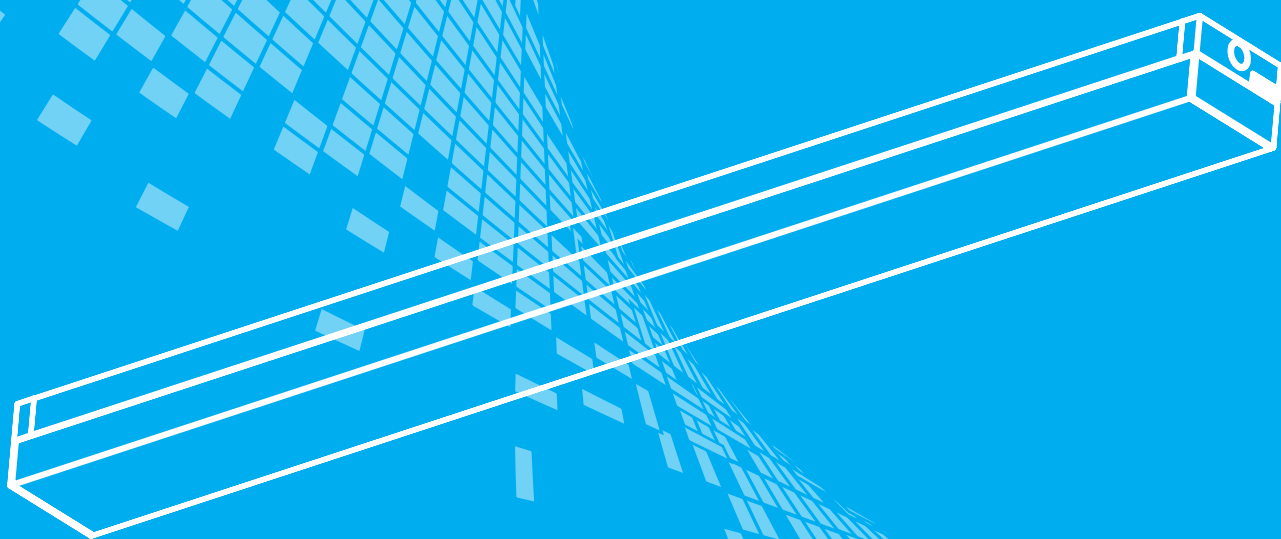

# LED LINEAR & PROFILES

## NEW PRODUCTS



Note: For Weatherproof Battens refer to LED EXTERIOR LIGHTS section of this catalogue.

# LED LOW PROFILE BATTEN

## SL9707, SL9709 TC BLADE



### DIMENSIONS

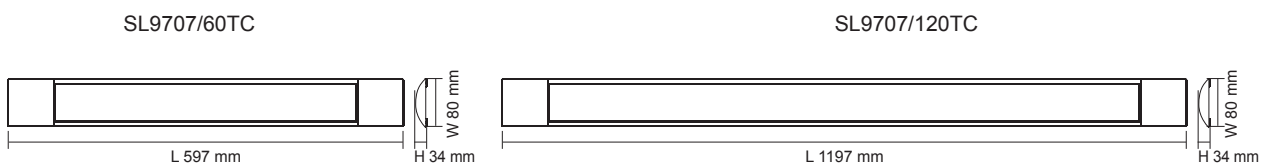

### CONSTRUCTION

- Select colour temperature with DIP switch
- Extruded aluminium body with plastic end cap
- Powder coated finish
- Rear cable channel allows easy wiring
- Opal polycarbonate diffuser
- High efficiency SMD LED chips
- Built-in constant current non-dimmable LED driver

### IP RATING

- IP20 suitable for interior use only

### INSTALLATION TYPE

- Surface mounted
- Suspended (Suspension unit required SSI1512, SSI1512)
- End to end installation

Model No.	Input	Power	Lumen	CCT	Beam Angle	CRI	Fitting Colour
SL9707/60TC	240V	20W	1800lm/1900lm/1850lm	3000K/4000K/5000K	110°	>80	White
SL9707/120TC	240V	35W	3300lm/3500lm/3400lm	3000K/4000K/5000K	110°	>80	White

DIP switch



Rear cable channel







SL9709 TC

## DIMENSIONS

SL9709/60TC

SL9709/120TC

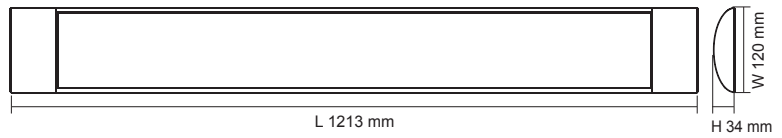
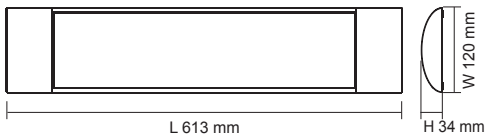

Model No.	Input	Power	Lumen	CCT	Beam Angle	CRI	Fitting Colour
SL9709/60TC	240V	25W	2200lm/2600lm/2400lm	3000K/4000K/5000K	110°	>80	White
SL9709/120TC	240V	48W	4400lm/5000lm/4800lm	3000K/4000K/5000K	110°	>80	White

## PHOTOMETRIC DATA (AT CCT 4000K) Unit: cd C0/C180 — C90/C270

SL9709/60TC at 4000K

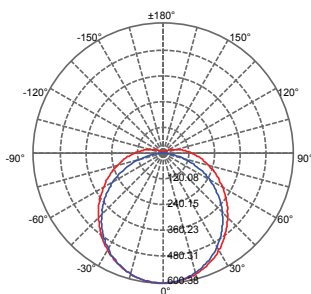

SL9709/120TC at 4000K

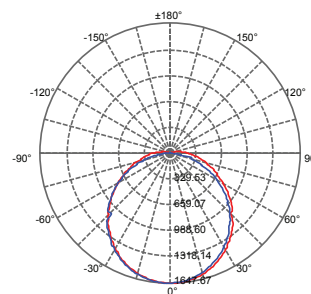

# LED DIFFUSED BATTEN

## SLD2000, SLD4000 LEDLINE



### DIMENSIONS

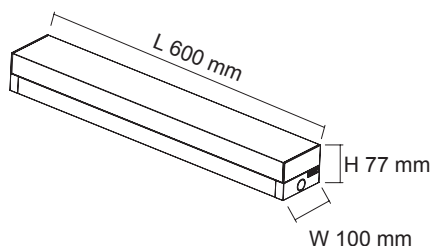

### CONSTRUCTION

- Pressed steel body
- Powder coated finish
- Opal PMMA diffuser
- High efficiency SMD LED chips
- Constant current non-dimmable LED driver fitted
- Large terminal block, easy installation
- Unique diffuser allows end to end installation

### IP RATING

- IP20 suitable for interior use only

### COLOUR TEMPERATURE

- 4000K Cool White

Model No.	Input	Power	Lumen	CCT	Beam Angle	CRI	Fitting Colour	Dimensions L x W x H
SLD2000CW	240V	20W	1900lm	4000K	120°	>80	White	600 x 100 x 77 mm
SLD4000CW	240V	40W	3800lm	4000K	120°	>80	White	1120 x 100 x 77 mm



SLD4000

## DIMENSIONS

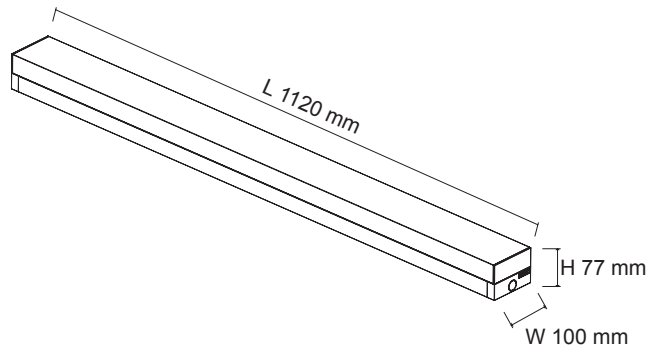

## DIMMING OPTIONS

- Trailing edge
- 1-10V analogue
- DALI / DSI, digital

## SENSOR OPTIONS

- Integrated microwave motion sensor
- Integrated microwave motion sensor with standBY function

## EMERGENCY OPTION

- Compliant to AS2293



## EMERGENCY CLASSIFICATIONS

### SLD2000

- D40@C0, C180
- C80@C90, C270

### SLD4000

- D63@C0, C180
- D32@C90, C270

## PHOTOMETRIC DATA UNIT: cd C0/C180 \_\_\_\_\_ C90/C270 \_\_\_\_\_

SLD2000CW

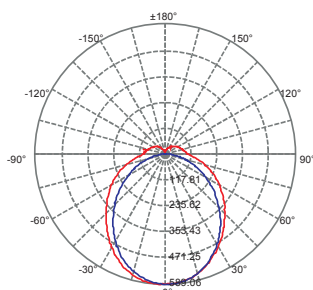

SLD4000CW

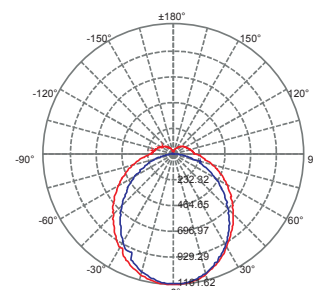

# LED DIFFUSED BATTEN

## SL9732 ECOLINE



### DIMENSIONS

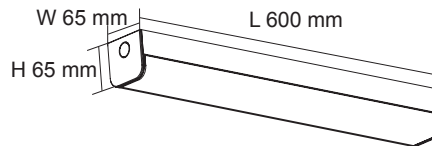

### CONSTRUCTION

- 65 mm narrow steel body
- Powder coated finish
- Opal polycarbonate diffuser
- High efficiency SMD LED chips
- Constant current non-dimmable LED driver fitted
- Large terminal block, easy installation
- Colour temperature selectable by DIP switch (TC models)

### IP RATING

- IP20 suitable for interior use only

### DIMMING OPTIONS

- Trailing edge (SL9732/20 only)
- DALI / DSI, digital

### EMERGENCY OPTIONS

- Compliant to AS2293
- LiFePO<sub>4</sub> battery



Model No.	Input	Power	Lumen	CCT	Beam Angle	CRI	Fitting Colour	Dimensions L x W x H
SL9732/20DL	240V	20W	1900lm	5700K	120°	>80	White	600 x 65 x 65 mm
SL9732/40DL	240V	40W	3800lm	5700K	120°	>80	White	1135 x 65 x 65 mm
SL9732/40CW	240V	40W	3800lm	4000K	120°	>80	White	1135 x 65 x 65 mm
SL9732/20TC	240V	20W	1900lm	3000/4000K/5700K	120°	>80	White	600 x 65 x 65 mm
SL9732/40TC	240V	40W	3800lm	3000/4000K/5700K	120°	>80	White	1135 x 65 x 65 mm

### PHOTOMETRIC DATA (AT CCT 4000K) Unit: cd C0/C180 — C90/C270

SL9732/20TC at 4000K

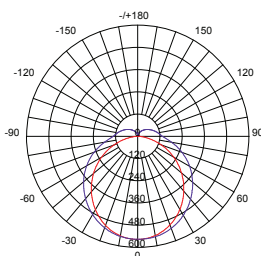

SL9732/40TC at 4000K

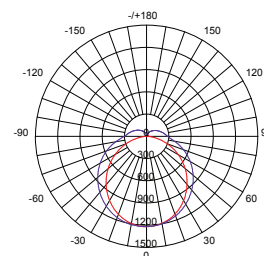



SL9732/40

## DIMENSIONS

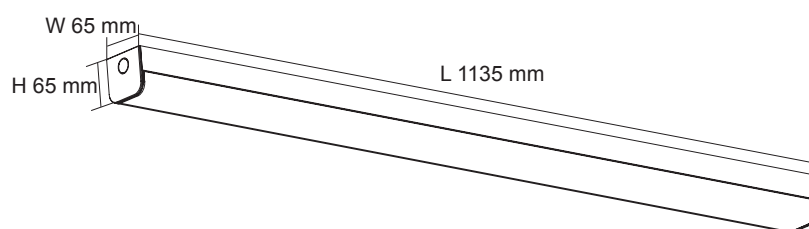

# LED BARE BATTEN

## STB/106, STB/206, STB/112, STB/212 TUBELINE

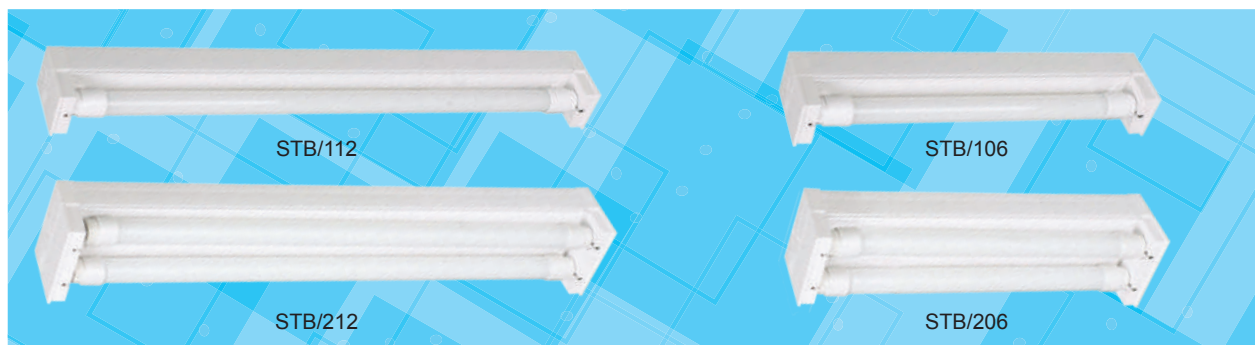

### CONSTRUCTION

- Pressed steel base with PVC body
- Powder coated finish
- High efficiency LED T8 tubes fitted
- Large terminal block, easy installation
- Safety fuse installed

### SENSOR OPTION

- Integrated microwave motion sensor

### DIMENSIONS

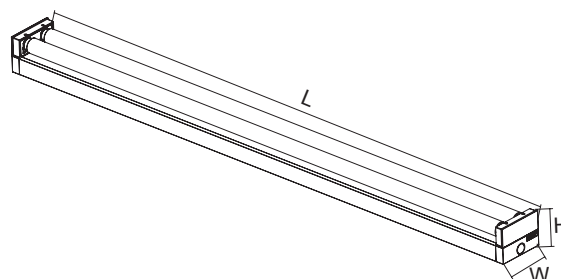

Model No.	Input	Power	Lumen	CCT	Beam Angle	CRI	Fitting Colour	Dimensions L x W x H
STB/106 WW	240V	9W	800lm	3000K	120°	>80	White	625 x 55 x 77 mm
STB/106 CW	240V	9W	850lm	4000K	120°	>80	White	625 x 55 x 77 mm
STB/106 DL	240V	9W	900lm	6000K	120°	>80	White	625 x 55 x 77 mm
STB/112 WW	240V	18W	1500lm	3000K	120°	>80	White	1225 x 55 x 77 mm
STB/112 CW	240V	18W	1600lm	4000K	120°	>80	White	1225 x 55 x 77 mm
STB/112 DL	240V	18W	1700lm	6000K	120°	>80	White	1225 x 55 x 77 mm
STB/206 WW	240V	2 x 9W	2 x 800lm	3000K	120°	>80	White	625 x 100 x 77 mm
STB/206 CW	240V	2 x 9W	2 x 850lm	4000K	120°	>80	White	625 x 100 x 77 mm
STB/206 DL	240V	2 x 9W	2 x 900lm	6000K	120°	>80	White	625 x 100 x 77 mm
STB/212 WW	240V	2 x 18W	2 x 1500lm	3000K	120°	>80	White	1225 x 100 x 77 mm
STB/212 CW	240V	2 x 18W	2 x 1600lm	4000K	120°	>80	White	1225 x 100 x 77 mm
STB/212 DL	240V	2 x 18W	2 x 1700lm	6000K	120°	>80	White	1225 x 100 x 77 mm

# EMERGENCY LED BARE BATTEN

## STB/206EM2500, STB/212EM2500 TUBELINE

- Compliant to AS2293
- LED charge status indicator
- Test switch
- Guaranteed 90 minutes emergency operation
- Intelligent automatic recharging function
- 16 hours charge time
- Deep discharge protection
- SELV compliant

Model No.	Input	Power	Power (EM Mode)	Emergency Classification	Battery	CRI	Beam Angle
STB/206EM2500	240V	18W	3W	D32@C0, D20@C90	2500mAh @ 4.8V	>80	120°
STB/212EM2500	240V	36W	3W	D32@C0, D20@C90	2500mAh @ 4.8V	>80	120°



# LED DIFFUSED BATTEN

## STD/106, STD/206, STD/112, STD/212 TUBELINE

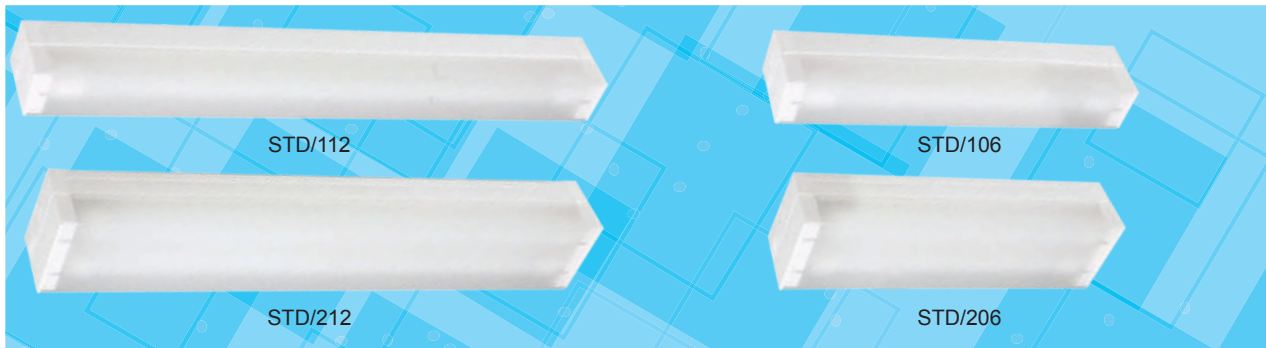

### CONSTRUCTION

- Pressed steel base with PVC body
- Powder coated finish
- High efficiency LED T8 tubes fitted
- Opal PMMA diffuser
- Large terminal block, easy installation
- Safety fuse installed

### SENSOR OPTION

- Integrated microwave motion sensor

### DIMENSIONS

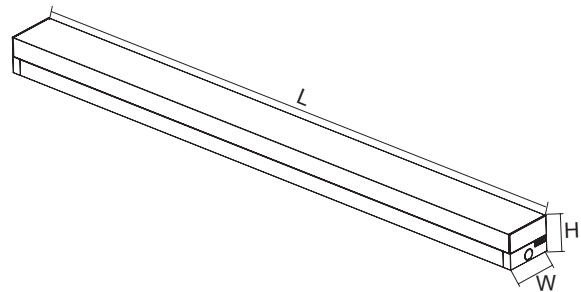

Model No.	Input	Power	Lumen	CCT	Beam Angle	CRI	Fitting Colour	Dimensions L x W x H
STD/106 WW	240V	9W	650lm	3000K	120°	>80	White	625 x 65 x 77 mm
STD/106 CW	240V	9W	700lm	4000K	120°	>80	White	625 x 65 x 77 mm
STD/106 DL	240V	9W	750lm	6000K	120°	>80	White	625 x 65 x 77 mm
STD/112 WW	240V	18W	1300lm	3000K	120°	>80	White	1225 x 65 x 77 mm
STD/112 CW	240V	18W	1400lm	4000K	120°	>80	White	1225 x 65 x 77 mm
STD/112 DL	240V	18W	1500lm	6000K	120°	>80	White	1225 x 65 x 77 mm
STD/206 WW	240V	2 x 9W	2 x 650lm	3000K	120°	>80	White	625 x 110 x 77 mm
STD/206 CW	240V	2 x 9W	2 x 700lm	4000K	120°	>80	White	625 x 110 x 77 mm
STD/206 DL	240V	2 x 9W	2 x 750lm	6000K	120°	>80	White	625 x 110 x 77 mm
STD/212 WW	240V	2 x 18W	2 x 1300lm	3000K	120°	>80	White	1225 x 110 x 77 mm
STD/212 CW	240V	2 x 18W	2 x 1400lm	4000K	120°	>80	White	1225 x 110 x 77 mm
STD/212 DL	240V	2 x 18W	2 x 1500lm	6000K	120°	>80	White	1225 x 110 x 77 mm

# EMERGENCY LED DIFFUSED BATTEN

## STD/206EM2500, STD/212EM2500 TUBELINE

- Compliant to AS2293
- LED charge status indicator
- Test switch
- Guaranteed 90 minutes emergency operation
- Intelligent automatic recharging function
- 16 hours charge time
- Deep discharge protection
- SELV compliant

Model No.	Input	Power	Power (EM Mode)	Emergency Classification	Battery	CRI	Beam Angle
STD/206EM2500	240V	18W	3W	D32@C0, D20@C90	2500mAh @ 4.8V	>80	120°
STD/212EM2500	240V	36W	3W	D32@C0, D20@C90	2500mAh @ 4.8V	>80	120°

# LED WIRE GUARD BATTEN

## STG/106, STG/206, STG/112, STG/212 TUBELINE



### CONSTRUCTION

- Pressed steel base with PVC body
- Powder coated finish
- High efficiency LED T8 tubes fitted
- Powder coated steel wire guard
- Large terminal block, easy installation
- Safety fuse installed

### SENSOR OPTION

- Integrated microwave motion sensor

### DIMENSIONS

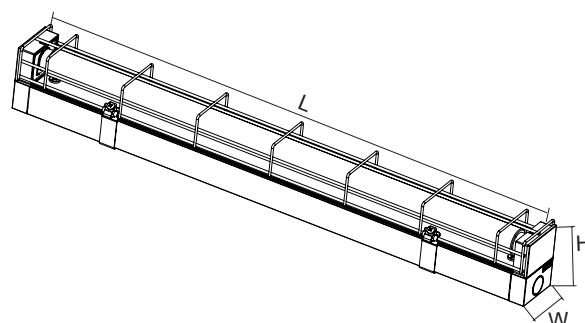

Model No.	Input	Power	Lumen	CCT	Beam Angle	CRI	Fitting Colour	Dimensions L x W x H
STG/106 WW	240V	9W	800lm	3000K	120°	>80	White	625 x 65 x 82 mm
STG/106 CW	240V	9W	850lm	4000K	120°	>80	White	625 x 65 x 82 mm
STG/106 DL	240V	9W	900lm	6000K	120°	>80	White	625 x 65 x 82 mm
STG/112 WW	240V	18W	1700lm	3000K	120°	>80	White	1225 x 65 x 82 mm
STG/112 CW	240V	18W	1750lm	4000K	120°	>80	White	1225 x 65 x 82 mm
STG/112 DL	240V	18W	1800lm	6000K	120°	>80	White	1225 x 65 x 82 mm
STG/206 WW	240V	2 x 9W	2 x 800lm	3000K	120°	>80	White	1225 x 110 x 82 mm
STG/206 CW	240V	2 x 9W	2 x 850lm	4000K	120°	>80	White	1225 x 110 x 82 mm
STG/206 DL	240V	2 x 9W	2 x 900lm	6000K	120°	>80	White	1225 x 110 x 82 mm
STG/212 WW	240V	2 x 18W	2 x 1700lm	3000K	120°	>80	White	1225 x 110 x 82 mm
STG/212 CW	240V	2 x 18W	2 x 1750lm	4000K	120°	>80	White	1225 x 110 x 82 mm
STG/212 DL	240V	2 x 18W	2 x 1800lm	6000K	120°	>80	White	1225 x 110 x 82 mm

# EMERGENCY LED WIRE GUARD BATTEN

## STG/206EM2500, STG/212EM2500 TUBELINE

- Compliant to AS2293
- LED charge status indicator
- Test switch
- Guaranteed 90 minutes emergency operation
- Intelligent automatic recharging function
- 16 hours charge time
- Deep discharge protection
- SELV compliant

Model No.	Input	Power	Power (EM Mode)	Emergency Classification	Battery	CRI	Beam Angle
STG/206EM2500	240V	18W	3W	D32@C0, D20@C90	2500mAh @ 4.8V	>80	120°
STG/212EM2500	240V	36W	3W	D32@C0, D20@C90	2500mAh @ 4.8V	>80	120°

# LED DIFFUSED BATTEN

## S9733L WIDELINE



### DIMENSIONS

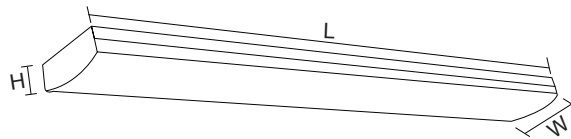

### CONSTRUCTION

- Wide steel body
- Powder coated finish
- Opal polycarbonate diffuser
- High efficiency SMD LED chips
- Built-in constant current non-dimmable LED driver

- Large terminal block, easy installation
- Select colour temperature with DIP switch (TC models)

### IP RATING

- IP20 suitable for interior use only

Model No.	Input	Power	Lumen	CCT	Beam Angle	CRI	Fitting Colour	Dimensions L x W x H
S9733L/212CW	240V	40W	3600lm	4000K	120°	>80	White	1144 x 160 x 60 mm
S9733L/212DL	240V	40W	3700lm	5700K	120°	>80	White	1144 x 160 x 60 mm
S9733L/206TC	240V	20W	1800lm	3000K/4000K/5700K	120°	>80	White	610 x 160 x 60 mm
S9733L/212TC	240V	38W	3700lm	3000K/4000K/5700K	120°	>80	White	1144 x 160 x 60 mm
S9733L/215TC	240V	65W	5400lm	3000K/4000K/5700K	120°	>80	White	1495 x 160 x 60 mm

### PHOTOMETRIC DATA

UNIT: cd C0/C180 — C90/C270

S9733L/212DL

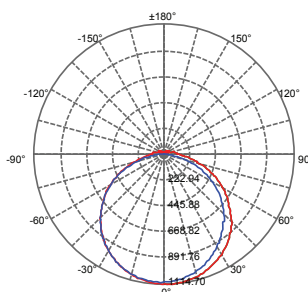

# LED LINKABLE

## SL9706 TC SEAMLESS SLIMLINE



### CONSTRUCTION

- Select colour temperature with DIP switch
- Polycarbonate body
- Opal polycarbonate diffuser
- High efficiency SMD LED chips
- Built-in constant current non-dimmable LED driver
- Double insulation 
- 1.2 m flex & 2 pin plug
- Mounting brackets and connectors (Straight & 10 cm flexible) included

### IP RATING

- IP20 suitable for interior use only

### ACCESSORIES

- SL9706/32CM LINK (L 320 mm)
- SL9706/76CM LINK (L 760 mm)

### MAXIMUM CONNECTIONS

Mixed connections maximum 240W

SL9706/280TC	1	2	3	4...	55pcs
SL9706/540TC	1	2	3	4...	25pcs
SL9706/840TC	1	2	3	4...	17pcs
SL9706/1140TC	1	2	3	4...	12pcs
SL9706/1440TC	1	2	3	4...	10pcs

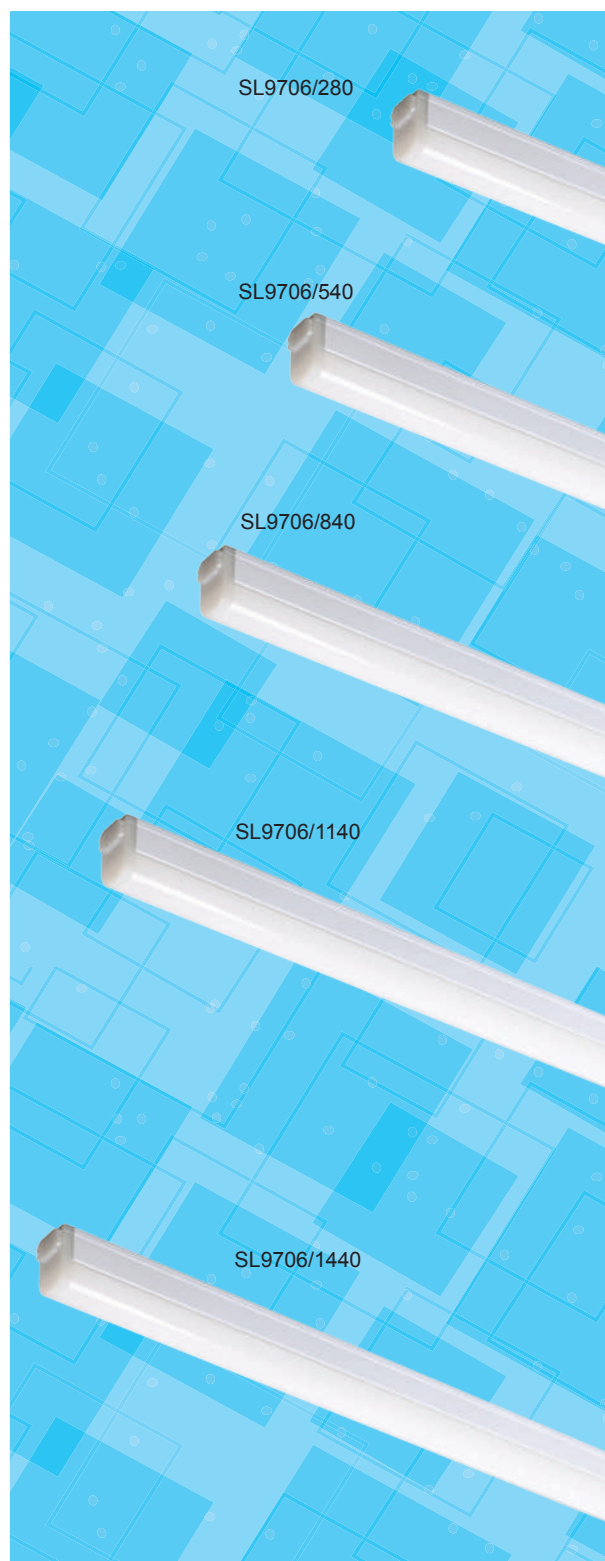

## DIMENSIONS

SL9706/280TC

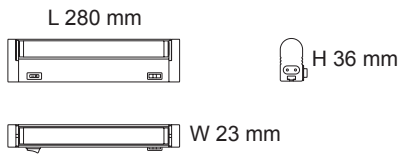

SL9706/1140TC

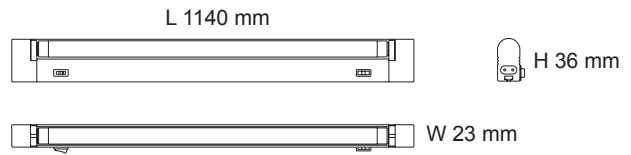

SL9706/540TC

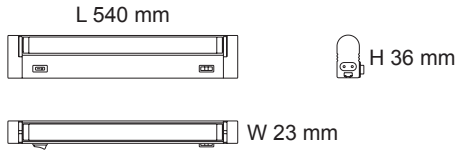

SL9706/1440TC

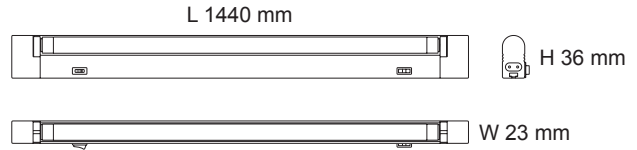

SL9706/840TC

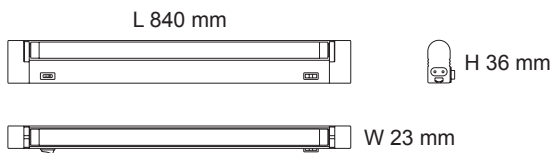

Model No.	Input	Power	Lumen	CCT	Beam Angle	CRI	Fitting Colour
<b>SL9706/280TC</b>	240V	4W	300lm/380lm/300lm	3000K/4000K/5000K	105°	>80	White
<b>SL9706/540TC</b>	240V	9W	750lm/800lm/750lm	3000K/4000K/5000K	105°	>80	White
<b>SL9706/840TC</b>	240V	13W	1050lm/1200lm/1050lm	3000K/4000K/5000K	105°	>80	White
<b>SL9706/1140TC</b>	240V	18W	1550lm/1600lm/1600lm	3000K/4000K/5000K	105°	>80	White
<b>SL9706/1440TC</b>	240V	22W	1800lm/2000lm/1800lm	3000K/4000K/5000K	105°	>80	White

## PHOTOMETRIC DATA (AT CCT 4000K) Unit: cd C0/C180 — C90/C270

SL9706/280TC  
at 4000K

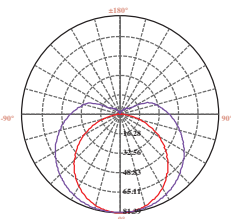

SL9706/540TC  
at 4000K

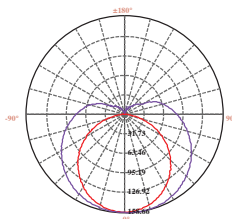

SL9706/840TC  
at 4000K

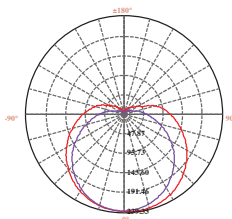

SL9706/1140TC  
at 4000K

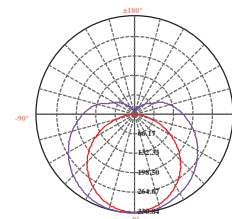

SL9706/1440TC  
at 4000K

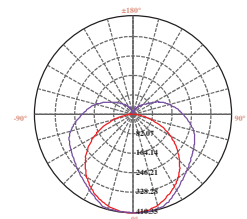

# LED CONNECTABLE PROFILE

## S9776 TITAN

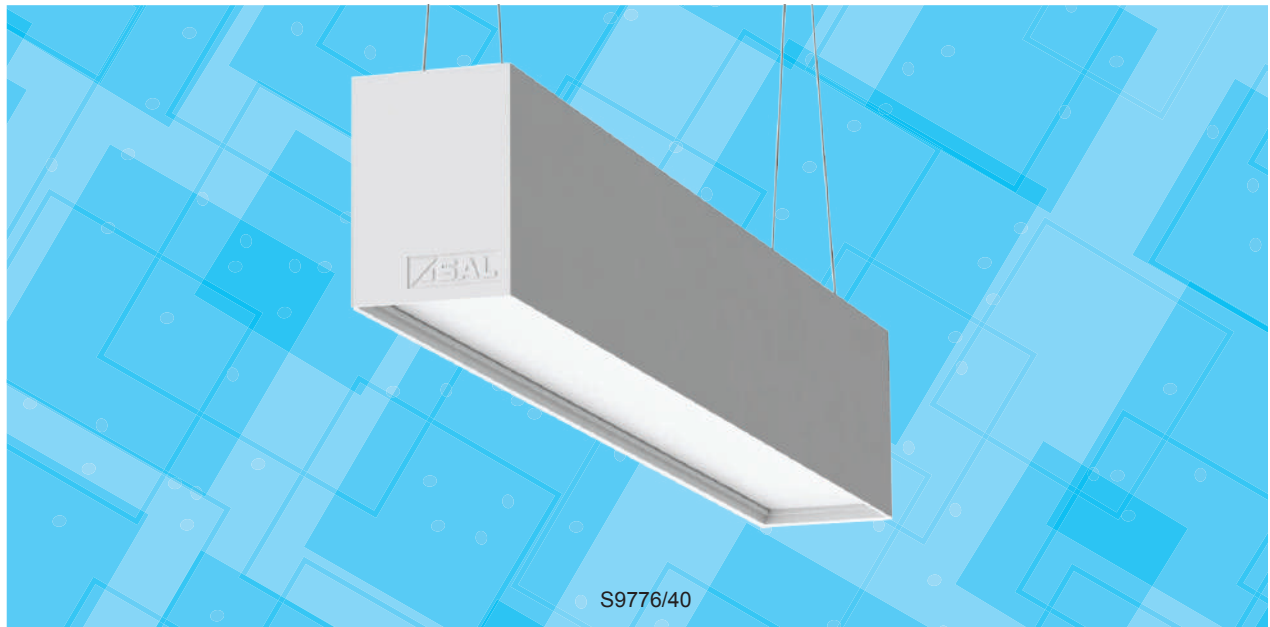

### DIMENSIONS

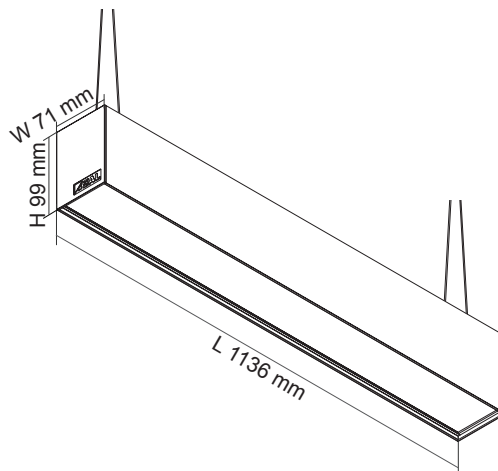

### CONSTRUCTION

- Extruded aluminium profile
- Opal polycarbonate diffuser
- High efficiency SMD LED chips
- Constant current non-dimmable LED driver fitted
- Adjustable suspension kit fitted (2 x SSY1512)
- Surface mounted (allow min. 70 mm clearance at both ends)
- Loop in loop out cable duct

### IP RATING

- IP20 suitable for interior use only

### COLOUR TEMPERATURE

- 4000K Cool White (standard)
- 3000K Warm White (option)
- 6000K Daylight (option)

### DIMMING OPTIONS

- Trailing edge
- DALI / DSI, digital

### ACCESSORY OPTION

- Straight link (S9776IP)



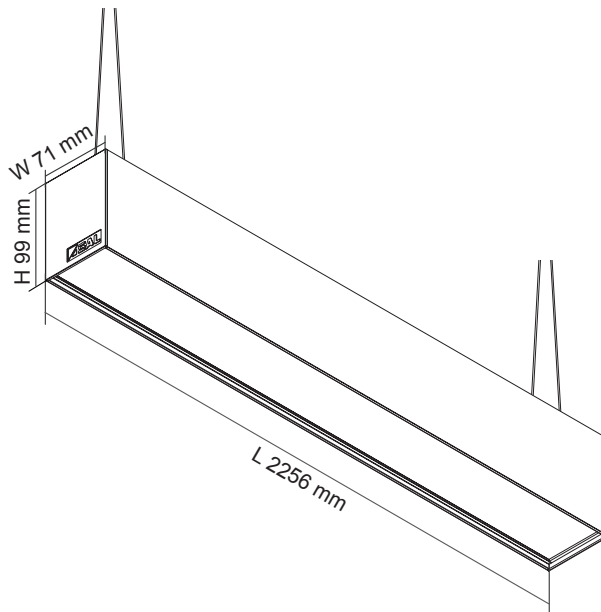
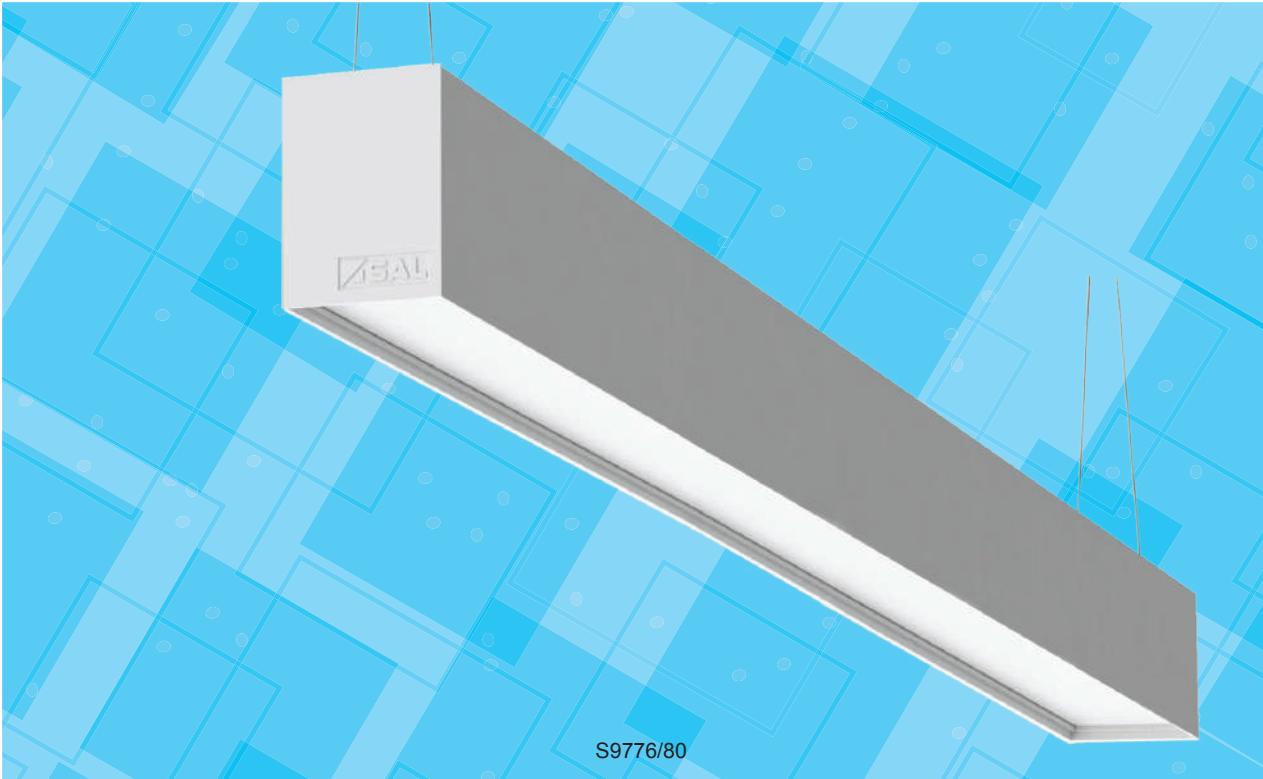

Model No.	Input	Power	Lumen	CCT	Beam Angle	CRI	Fitting Colour	Dimensions L x W x H
<b>S9776/40CW</b>	240V	40W	3000lm	4000K	90°	>80	White	1136 x 71 x 99 mm
<b>S9776/80CW</b>	240V	80W	6000lm	4000K	90°	>80	White	2256 x 71 x 99 mm

Specifications above are for reference only and may vary without prior notice



# LED LINKABLE S9775 PHOENIX

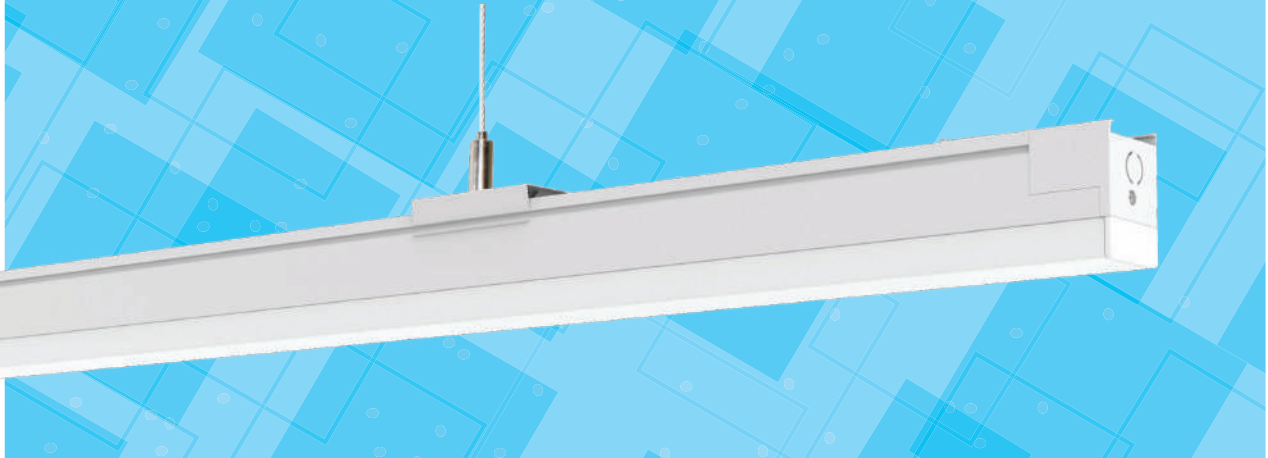

## DIMENSIONS

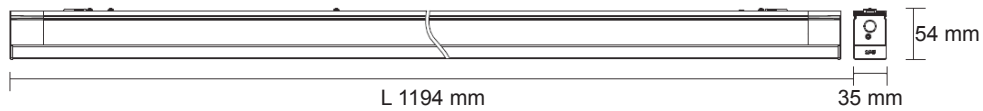

## CONSTRUCTION

- Extruded aluminium profile
- Opal polycarbonate diffuser
- High efficiency SMD LED chips
- Built in 1-10V dimmable LED driver
- Surface mounted or suspended (suspension kit required)
- Two mounting clips included

## IP RATING

- IP20 suitable for interior use only

## COLOUR TEMPERATURE

- 4000K Cool White (standard)
- 3000K Warm White (option)
- 6000K Daylight (option)

## MAXIMUM CONNECTIONS



## ACCESSORIES

- **S9775LP** L-shaped link bracket
- **S9775IP** Straight link bracket
- **SSI1512** Two Suspension kit required per fitting



S9775LP  
L-shaped link bracket



S9775IP  
Straight link bracket



Suspension wire unit

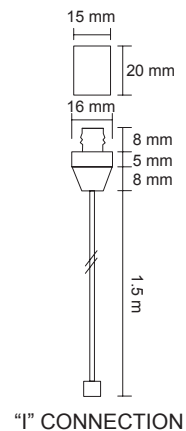

"I" CONNECTION

Model No.	Input	Power	Lumen	CCT	Beam Angle	CRI	Fitting Colour	Dimensions L x W x H
S9775CW	240V	30W	2800lm	4000K	120°	>80	White	1194 x 35 x 54 mm



**PHOTOMETRIC DATA** UNIT: cd C0/C180 — C90/C270 —

S9775CW

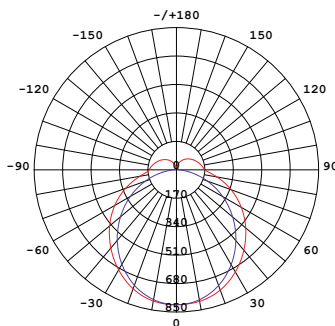

Specifications above are for reference only and may vary without prior notice





[www.sal.net.au](http://www.sal.net.au)

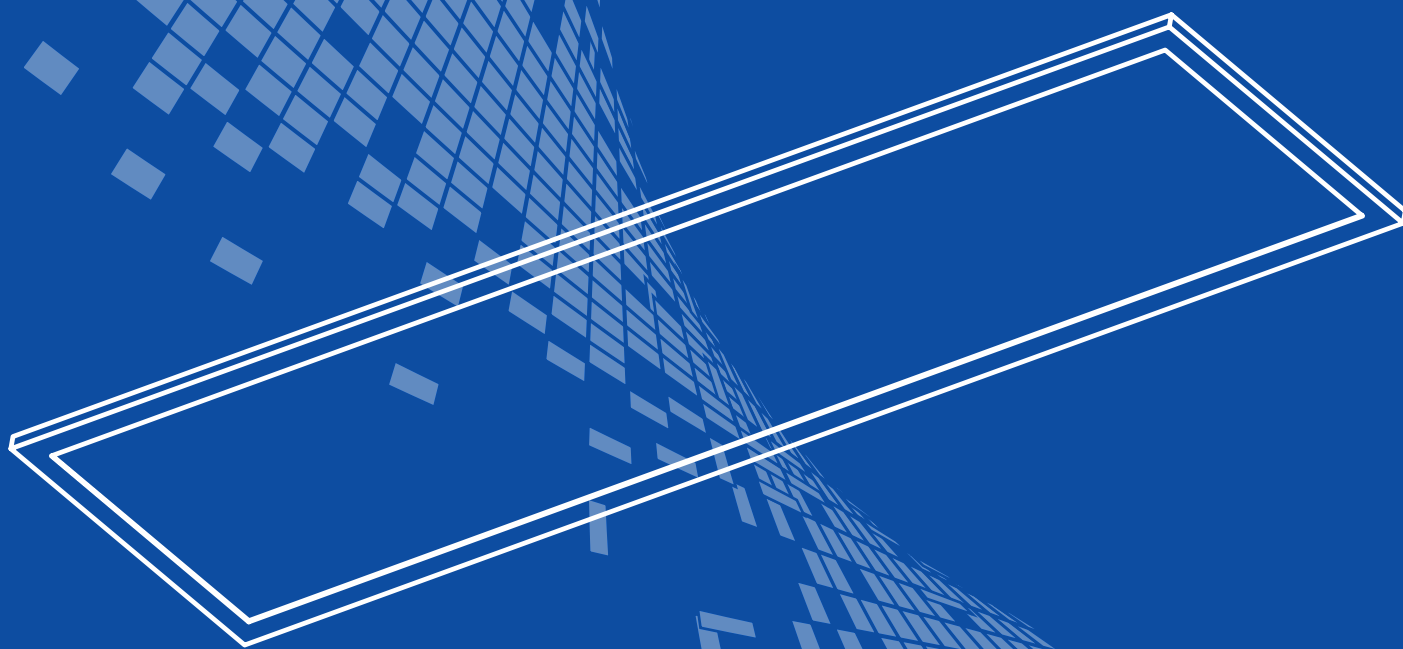

# LED PANELS & TROFFERS

## NEW PRODUCTS



p132  
S9714HO/TC PANEL



p133  
S9714HC PANEL



# LED PANEL

## S9714 PANEL



### DIMENSIONS

S9714/306

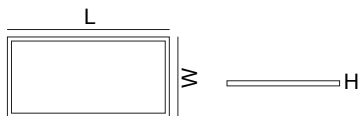

S9714/606

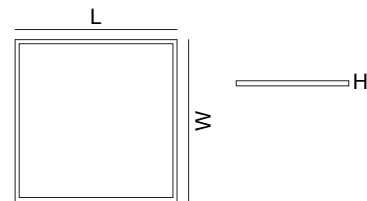

S9714/312

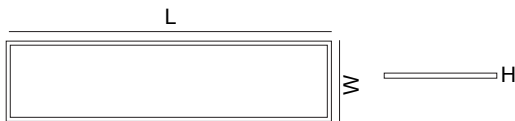

S9714/612

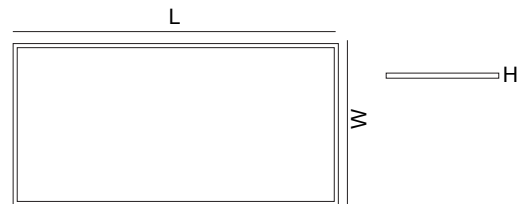

### CONSTRUCTION

- Extruded aluminium frame
- Powder coated finish
- High efficiency opal polystyrene back diffuser
- High efficiency SMD LED chips
- Constant current non-dimmable LED driver fitted
- 1.2 m flex & 2 pin plug
- Select colour temperature with DIP switch (TC models)

### IP RATING

- IP20 suitable for interior use only

### DIMMING OPTIONS

- Trailing edge (excluding S9714/612)
- 1-10V analogue (excluding S9714/612)
- DALI / DSI, digital

### INSTALLATION TYPES

- Standard metric T-Bar ceiling recessed installation  
Air Slot models to suit –/306, –/312 panel sizes
- Plaster ceiling recessed installation  
(S9704 Plaster ceiling frame required)
- Clean Room models to suit –/606, –/312 panel sizes
- Surface mounted installation  
(S306FM, S312FM, S606FM or S612FM surface mounted frame required)
- Suspended installation  
(SSI1512 & S9714SP6 or SSI1512 & S9714SP6 Suspension Kits required)



Model No.	Input	Power	Lumen	CCT	Beam Angle	CRI	Fitting Colour	Dimensions L x W x H
S9714/306 CW	240V	18W	2000lm	4000K	100°	>80	White	595 x 295 x 12 mm
S9714/606 CW	240V	30W	3200lm	4000K	100°	>80	White	595 x 595 x 12 mm
S9714/606 DL	240V	30W	3300lm	6000K	100°	>80	White	595 x 595 x 12 mm
S9714/312 CW	240V	30W	3100lm	4000K	100°	>80	White	1195 x 295 x 12 mm
S9714/312 DL	240V	30W	3200lm	6000K	100°	>80	White	1195 x 295 x 12 mm
S9714/612 CW	240V	48W	5200lm	4000K	100°	>80	White	1195 x 595 x 12 mm

Model No.	Input	Power	Lumen	CCT	Beam Angle	CRI	Fitting Colour	Dimensions L x W x H
S9714/306TC	240V	18W	1900lm/2000lm/2100lm	3000K/4000K/5700K	100°	>80	White	595 x 295 x 12 mm
S9714/606TC	240V	30W	3100lm/3200lm/3300lm	3000K/4000K/5700K	100°	>80	White	595 x 595 x 12 mm
S9714/312TC	240V	30W	3000lm/3100lm/3200lm	3000K/4000K/5700K	100°	>80	White	1195 x 295 x 12 mm
S9714/612TC	240V	48W	5000lm/5200lm/5300lm	3000K/4000K/5700K	100°	>80	White	1195 x 595 x 12 mm

## PHOTOMETRIC DATA

Unit: cd C0/C180 — C90/C270 —

S9714/306 CW

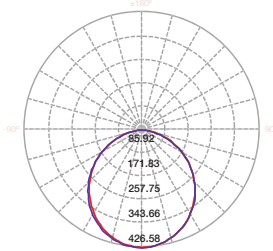

S9714/312 CW

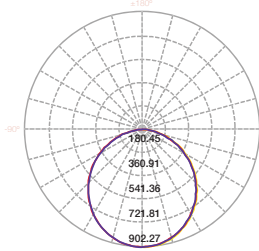

S9714/606 CW

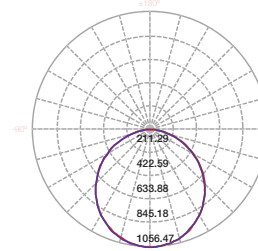

S9714/612 CW

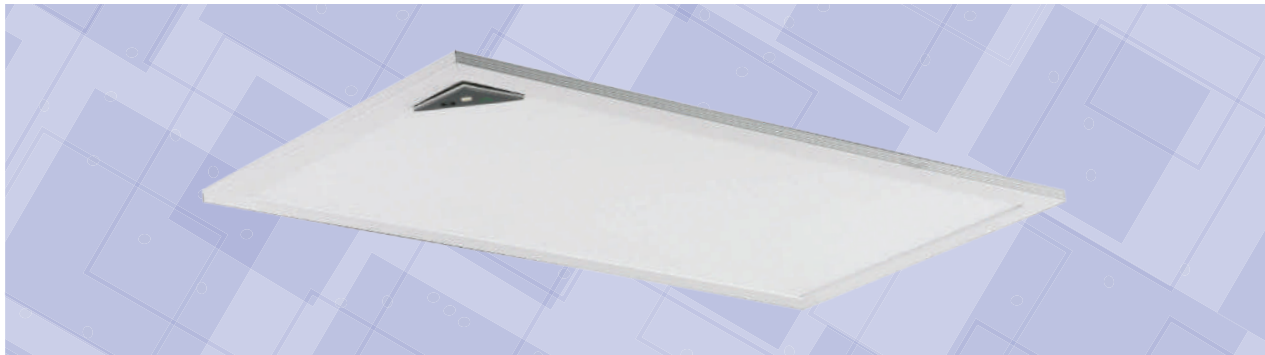
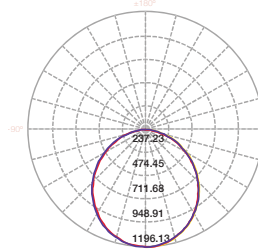

## EMERGENCY

- Compliant to AS2293
- Emergency classification: D32
- LED charge status indicator
- Test switch
- Guaranteed 90 minutes emergency operation

- Intelligent automatic recharging function
- 16 hours charge time
- Deep discharge protection
- SELV compliant
- Battery type: 2500mAh @ 4.8V

Model No.	Input	Power	Power (EM Mode)	Emergency Classification	Beam Angle	CRI	Battery
S9714/306EM	240V	18W	2W	D32	100°	>80	2500mAh @ 4.8V
S9714/606EM	240V	30W	2W	D32	100°	>80	2500mAh @ 4.8V
S9714/312EM	240V	30W	2W	D32	100°	>80	2500mAh @ 4.8V
S9714/612EM	240V	48W	2W	D32	100°	>80	2500mAh @ 4.8V

# LED HIGH OUTPUT PANEL

## S9714HO/TC PANEL

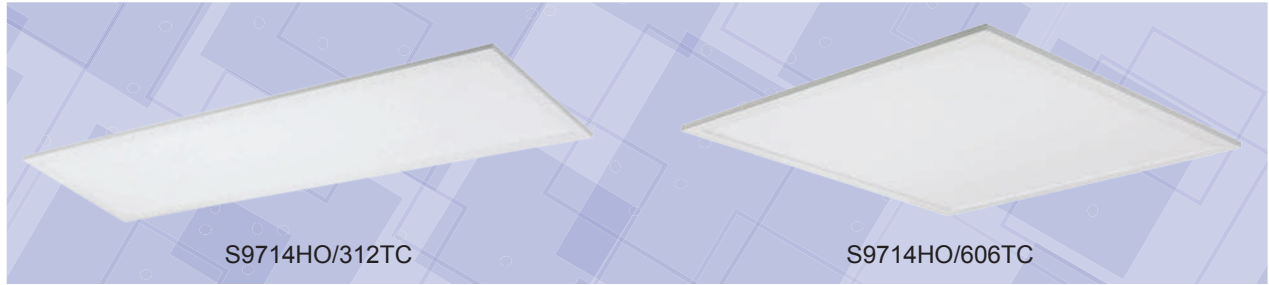

### DIMENSIONS

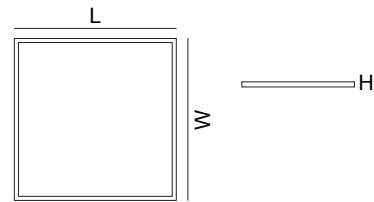

### CONSTRUCTION

- Colour temperature selectable by DIP switch
- Extruded aluminium frame
- Powder coated finish
- High efficiency opal polystyrene back diffuser
- High efficiency SMD LED chips
- Constant current non-dimmable LED driver fitted
- 1.2 m flex & 2 pin plug
- RippleFREE driver for visual comfort
- Low glare
- Emergency option available

### IP RATING

- IP20 suitable for interior use only

### DIMMING OPTIONS

- 1-10V analogue
- DALI / DSI, digital

### INSTALLATION TYPES

- Standard metric T-Bar ceiling recessed installation  
Air Slot models to suit –/312 panel sizes
- Plaster ceiling recessed installation  
(S9704 Plaster ceiling frame required)
- Clean Room models to suit –/606, –/312 panel sizes
- Surface mounted installation (S312FM, S606FM surface mounted frame required)
- Suspended installation  
(SSI1512 & S9714SP6 or SSI1512 & S9714SP6 Suspension Kits required)

Model No.	Input	Power	Lumen	CCT	Beam Angle	CRI	Fitting Colour	Dimensions L x W x H
S9714HO/312TC	240V	40W	3600lm/ 4000lm/ 3800lm	3000K/4000K/5700K	100°	>80	White	1195 x 295 x 12 mm
S9714HO/606TC	240V	40W	3700lm/ 4200lm/ 4000lm	3000K/4000K/5700K	100°	>80	White	595 x 595 x 12 mm

### WIRING DIAGRAM

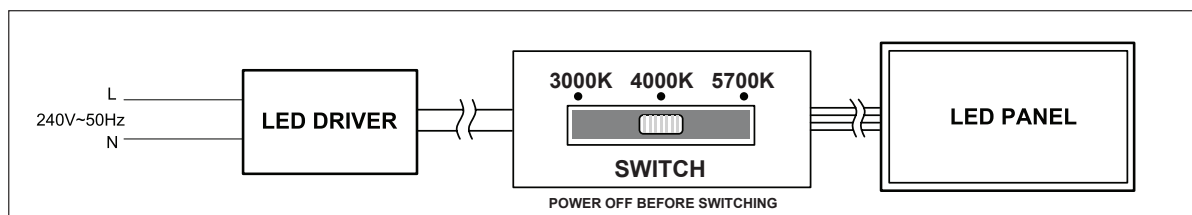

# LED HIGH CRI PANEL

## S9714HC PANEL



LOW COI SUITABLE FOR USE IN HOSPITALS & MEDICAL CENTRES  
TO ACHIEVE COMPLIANCE WITH AS/NZS 1680.2.5

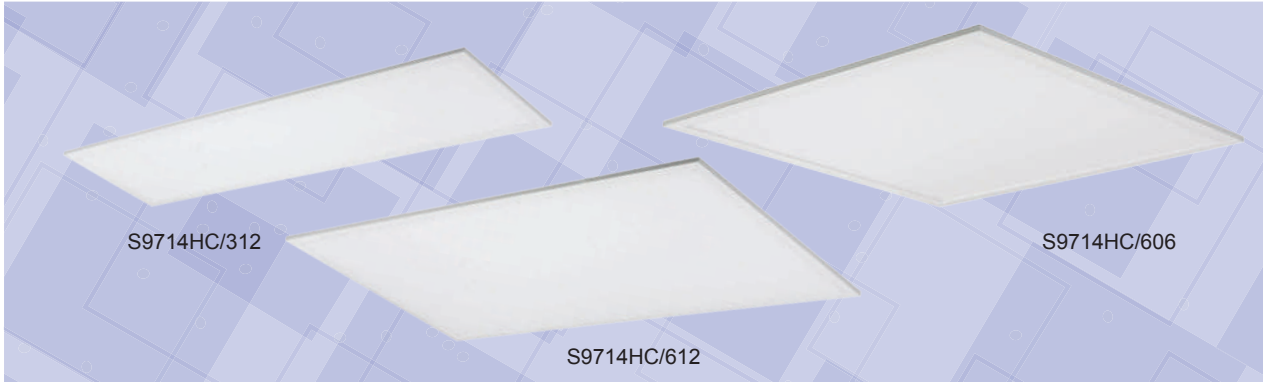

### DIMENSIONS

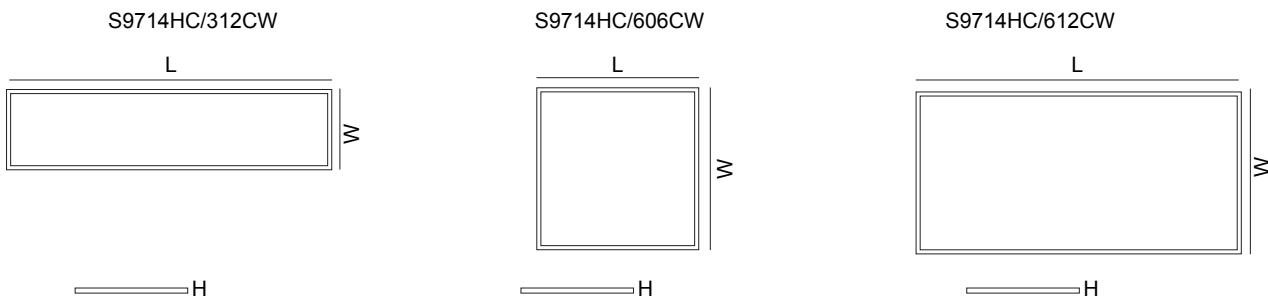

### CONSTRUCTION

- Extruded aluminium frame
- Powder coated finish
- High efficiency opal polystyrene back diffuser
- High efficiency SMD LED chips
- Constant current non-dimmable LED driver fitted
- 1.2 m flex & 2 pin plug
- Cyanosis Observation Index (COI) compliant with AS/NZS 1680.2.5
- High colour rendering
- Emergency option available

### IP RATING

- IP20 suitable for interior use only

### DIMMING OPTIONS

- 1-10V analogue (excluding S9714HC/612)
- DALI / DSI, digital

### INSTALLATION TYPES

- Standard metric T-Bar ceiling recessed installation  
Air Slot models to suit –/312 panel sizes
- Plaster ceiling recessed installation  
(S9704 Plaster ceiling frame required)
- Clean Room models to suit –/606, –/312 panel sizes
- Surface mounted installation (S312FM, S606FM or S612FM surface mounted frame required)
- Suspended installation  
(SS1512 & S9714SP6 or SSY1512 & S9714SP6 Suspension Kits required)

Model No.	Input	Power	Lumen	CCT	Beam Angle	CRI	COI	Fitting Colour	Dimensions L x W x H
S9714HC/312CW	240V	40W	2800lm	4000K	100°	>95	<1.8	White	1195 x 295 x 12 mm
S9714HC/606CW	240V	40W	3200lm	4000K	100°	>95	<1.8	White	595 x 595 x 12 mm
S9714HC/612CW	240V	50W	4000lm	4000K	100°	>95	<1.8	White	1195 x 595 x 12 mm



# LED AIRSLOT PANEL

## S9714-AS PANEL

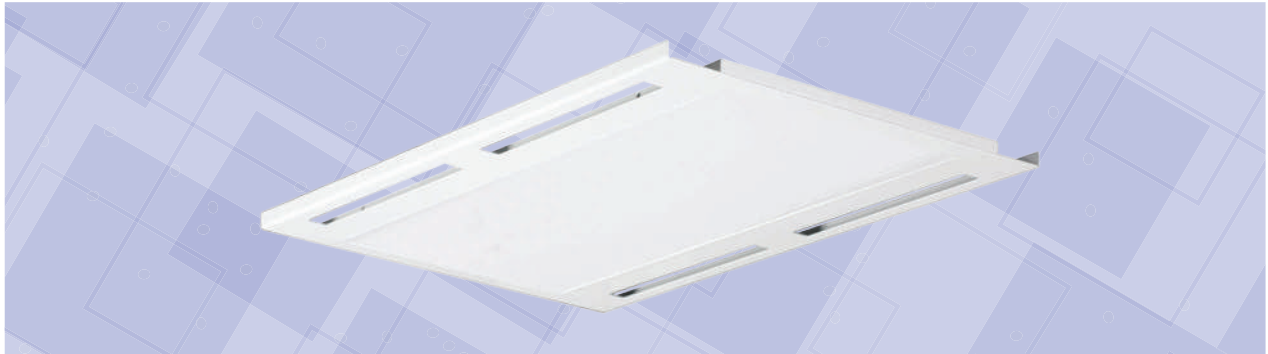

### DIMENSIONS

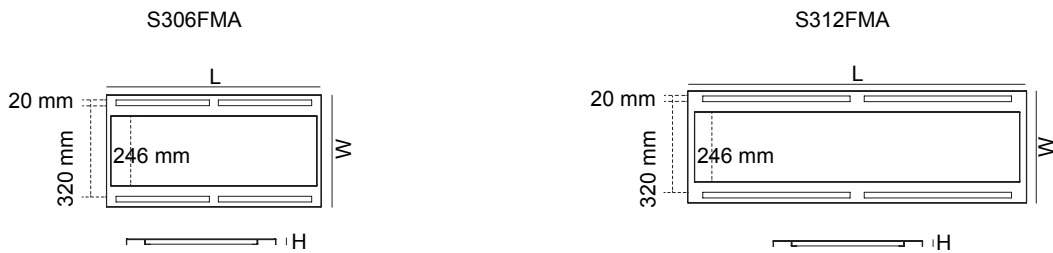

### CONSTRUCTION

- Pressed steel frame
- Powder coated finish

### AIR SLOT PANELS

Model No.	Input	Power	Lumen	CCT	Beam Angle	CRI	Fitting Colour	Dimensions L x W x H
S9714/306AS/CW	240V	18W	2000lm	4000K	100°	>80	White	596 x 396 x 16 mm
S9714/312AS/CW	240V	30W	3100lm	4000K	100°	>80	White	1196 x 396 x 16 mm
S9714/312AS/DL	240V	30W	3200lm	6000K	100°	>80	White	1196 x 396 x 16 mm
S9714/306AS/TC	240V	18W	1900lm/2000lm/2100lm	3000K/4000K/5700K	100°	>80	White	596 x 396 x 16 mm
S9714/312AS/TC	240V	30W	3000lm/3100lm/3200lm	3000K/4000K/5700K	100°	>80	White	1196 x 396 x 16 mm
S9714HO/312AS/TC	240V	40W	3600lm/ 4000lm/ 3800lm	3000K/4000K/5700K	100°	>80	White	1196 x 396 x 16 mm
S9714HC/312AS/CW	240V	40W	2800lm	4000K	100°	>95	White	1196 x 396 x 16 mm

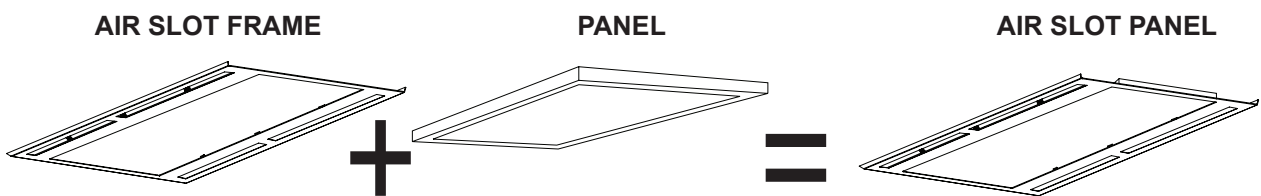

# LED PANEL INSTALLATION TYPE

## S9704 RECESSED CEILING FRAME

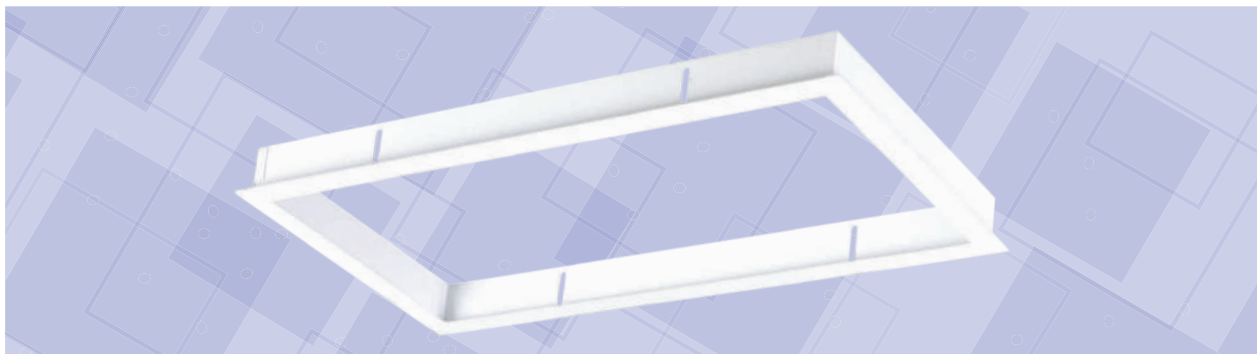

### DIMENSIONS

S9704/214 FRAME  L x W: 310 x 610 mm

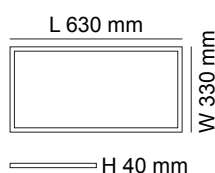

S9704/414 FRAME  L x W: 610 x 610 mm

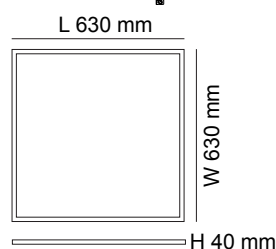

S9704/228 FRAME  L x W: 310 x 1210 mm

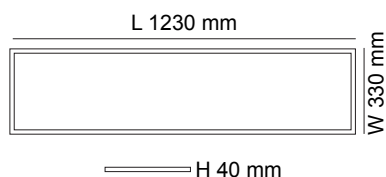

S9704/328 FRAME  L x W: 610 x 1210 mm



### CONSTRUCTION

- Pressed steel frame
- Powder coated finish

Model No.*	Suitable LED Fittings	Fitting Colour
<b>S9704/214 FRAME</b>	S9714/306, S9714/306EM, S9724/306, S9734/306L	White
<b>S9704/414 FRAME</b>	S9714/606, S9714HO/606TC, S9714HC/606CW, S9714/606EM, S9724/606, S9734/606L	White
<b>S9704/228 FRAME</b>	S9714/312, S9714HO/312TC, S9714HC/312CW, S9714/312EM, S9724/312, S9734/312L	White
<b>S9704/328 FRAME</b>	S9714/612, S9714HC/612CW, S9714/612EM	White

\*LED fitting ordered separately

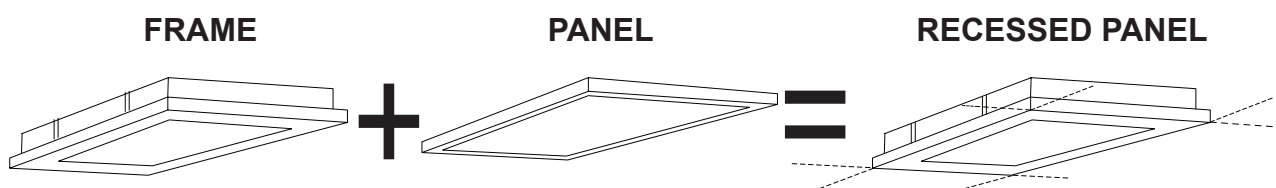

# LED CLEANROOM PANEL

## S9714-CR BISMARCK

**IP65**



### DIMENSIONS

S606FMCR  L x W: 636 x 636 mm

S312FMCR  L x W: 1206 x 336 mm

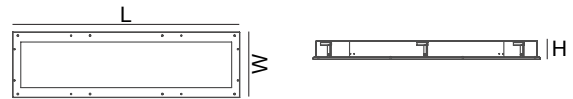
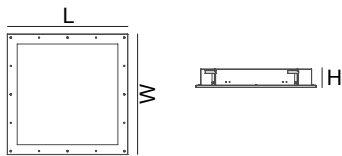

### CONSTRUCTION

- Fully enclosed and sealed plaster troffer frame
- Adjustable flip-out mounting brackets on two sides
- Pressed steel frame
- Powder coated finish

- Purposely sealed shockproof clear polycarbonate lens
- 1.5 m flex & 3 pin plug fitted

### IP RATING

- IP65 weatherproof front only

### CLEAN ROOM PANELS

Model No.	Input	Power	Lumen	CCT	Beam Angle	CRI	Fitting Colour	Dimensions L x W x H
S9714/606CR/CW	240V	30W	3200lm	4000K	100°	>80	White	656 x 656 x 108 mm
S9714/606CR/DL	240V	30W	3300lm	6000K	100°	>80	White	656 x 656 x 108 mm
S9714HC/606CR/CW	240V	40W	3200lm	4000K	100°	>95	White	656 x 656 x 108 mm
S9714/606CR/TC	240V	30W	3100lm/3200lm/3300lm	3000K/4000K/5700K	100°	>80	White	656 x 656 x 108 mm
S9714HO/606CR/TC	240V	40W	3700lm/ 4200lm/ 4000lm	3000K/4000K/5700K	100°	>80	White	656 x 656 x 108 mm
S9714/312CR/CW	240V	30W	3100lm	4000K	100°	>80	White	1236 x 336 x 108 mm
S9714/312CR/DL	240V	30W	3200lm	6000K	100°	>80	White	1236 x 336 x 108 mm
S9714HC/312CR/CW	240V	40W	2800lm	4000K	100°	>95	White	1236 x 336 x 108 mm
S9714/312CR/TC	240V	30W	3100lm/3200lm/3300lm	3000K/4000K/5700K	100°	>80	White	1236 x 336 x 108 mm
S9714HO/312CR/TC	240V	40W	3600lm/ 4000lm/ 3800lm	3000K/4000K/5700K	100°	>80	White	1236 x 336 x 108 mm

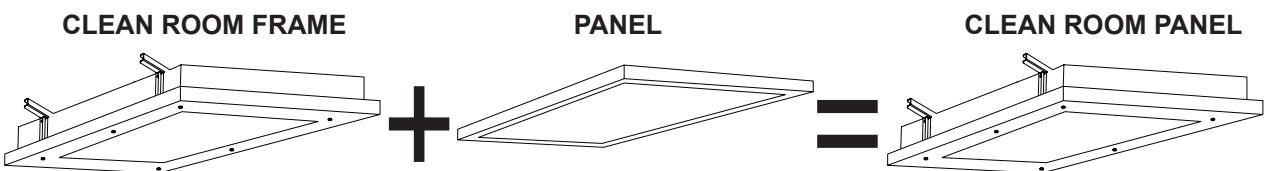



# LED PANEL INSTALLATION TYPE

## S-FM SURFACE MOUNTED FRAME

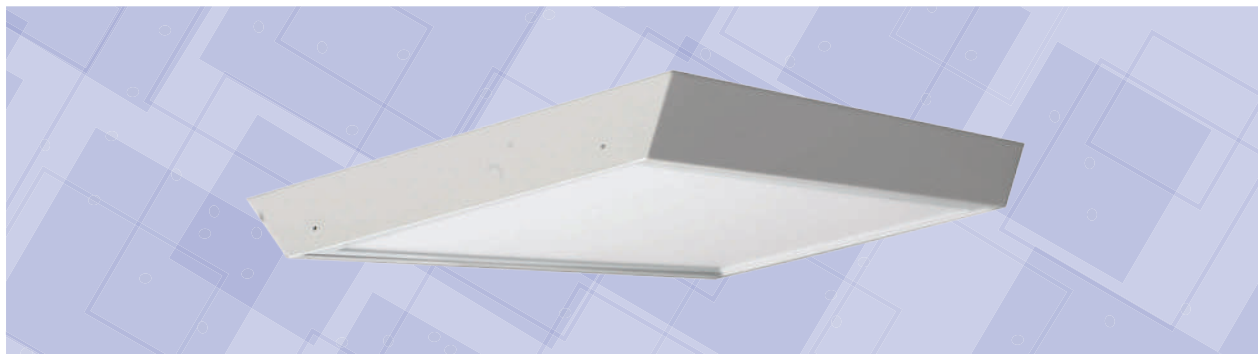

### DIMENSIONS

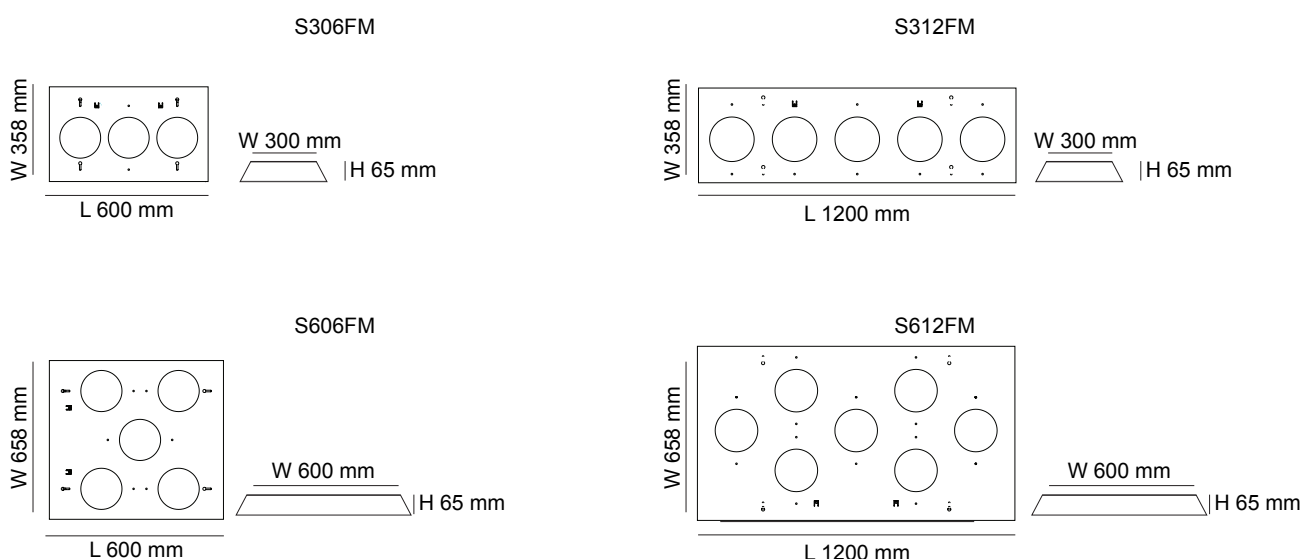

### CONSTRUCTION

- Pressed steel frame
- Powder coated finish
- Will accommodate ESS102 plug base

Model No.*	Suitable LED Fittings	Fitting Colour
<b>S306FM</b>	S9714/306, S9714/306EM	White
<b>S312FM</b>	S9714/312, S9714HO/312TC, S9714HC/312CW, S9714/312EM	White
<b>S606FM</b>	S9714/606, S9714HO/606TC, S9714HC/606CW, S9714/606EM	White
<b>S612FM</b>	S9714/612, S9714HC/612CW, S9714/612EM	White

\*LED fitting ordered separately

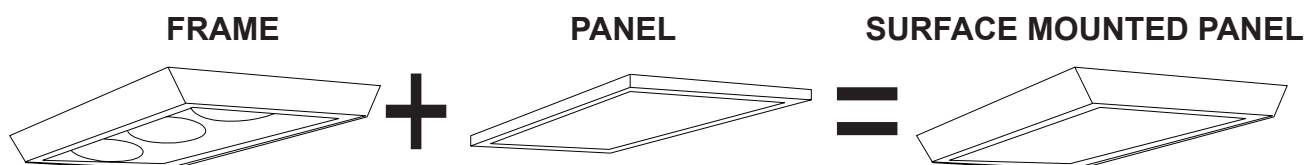

# LED PANEL INSTALLATION TYPE

## SUSPENSION KITS



### DIMENSIONS



### CONSTRUCTION

- M10 size ceiling attachment
- 1.2 mm stainless steel wire carrying weight up to 45 kg
- M10 size griplock system



S9714SP6  
Bracket for Suspension (Pack of 6)

### SUSPENSION KITS

Model No.	Description	Size
SSI1512	"I" Suspension Kit	1.8M
SSY1512	"Y" Suspension Kit	1.8M
S9714SP6	Bracket for Suspension (Pack of 6)	

Size	Suspension Kits			Bracket
	SSI1512 "I"	SSY1512 "Y"	S9714SP6*	
306	4	or 2	plus 1	
312	4	or 2	plus 1	
606	4	or -	plus 1	
612	6	or -	plus 1	

\*S9714SP6 brackets required with both suspension kit types

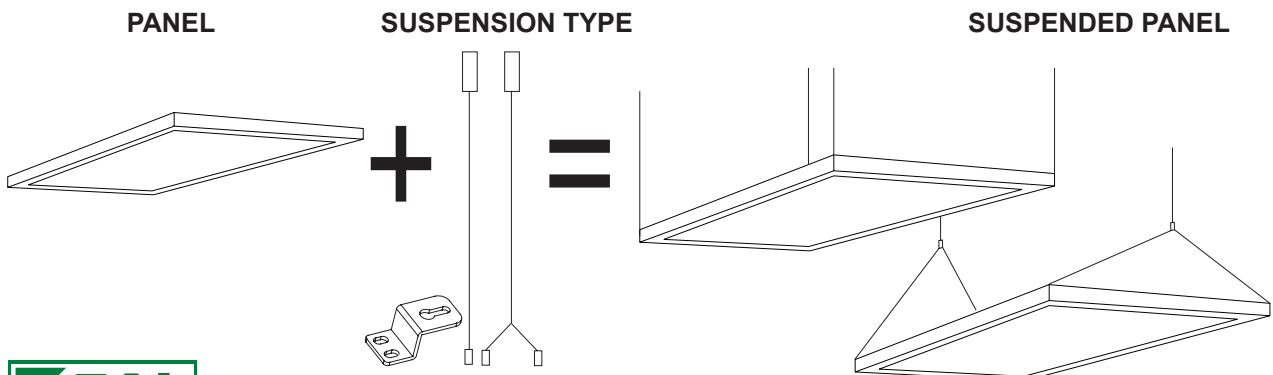

# LED T8 LOUVER TROFFER

## S9724 L-LINE



### DIMENSIONS

S9724/306

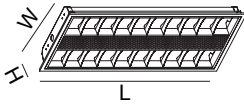

S9724/606

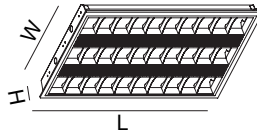

S9724/312

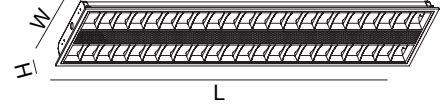

### CONSTRUCTION

- Pressed steel body
- Powder coated finish
- Double parabolic matt aluminium louvre
- LED T8 tubes fitted
- Safety fuse installed
- 1.5 m flex & 3 pin plug

### IP RATING

- IP20 suitable for interior use only

### INSTALLATION TYPES

- Standard metric T-Bar ceiling recessed installation  
Air Slot models to suit –/306, –/312 panel sizes
- Plaster ceiling recessed installation  
(S9704 Plaster ceiling frame required)

Model No.	Input	Power	Lumen	CCT	Beam Angle	CRI	Fitting Colour	No. of T8 Tubes	Dimensions L x W x H
S9724/306WW	240V	2 x 9W	1100lm	3000K	120°	>80	White	LT8/60 x 2	595 x 295 x 85 mm
S9724/306CW	240V	2 x 9W	1100lm	4000K	120°	>80	White	LT8/60 x 2	595 x 295 x 85 mm
S9724/306DL	240V	2 x 9W	1100lm	6000K	120°	>80	White	LT8/60 x 2	595 x 295 x 85 mm
S9724/312WW	240V	2 x 18W	2200lm	3000K	120°	>80	White	LT8/120 x 2	1195 x 295 x 85 mm
S9724/312CW	240V	2 x 18W	2200lm	4000K	120°	>80	White	LT8/120 x 2	1195 x 295 x 85 mm
S9724/312DL	240V	2 x 18W	2200lm	6000K	120°	>80	White	LT8/120 x 2	1195 x 295 x 85 mm
S9724/606WW	240V	3 x 9W	1800lm	3000K	120°	>80	White	LT8/60 x 3	595 x 595 x 85 mm
S9724/606CW	240V	3 x 9W	1800lm	4000K	120°	>80	White	LT8/60 x 3	595 x 595 x 85 mm
S9724/606DL	240V	3 x 9W	1800lm	6000K	120°	>80	White	LT8/60 x 3	595 x 595 x 85 mm

# LED LOUVER TROFFER

## S9734 L-LINE MKII



### DIMENSIONS

S9734/306L

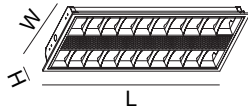

S9734/606L

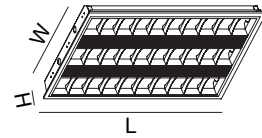

S9734/312L

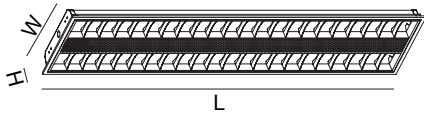

S9734/612L

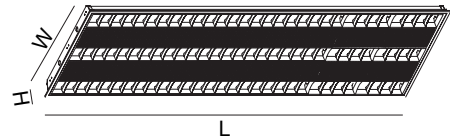

### CONSTRUCTION

- Pressed steel body
- Powder coated finish
- Double parabolic matt aluminium louver
- High efficiency SMD LED chips
- Opal polycarbonate LED diffuser
- Constant current non-dimmable LED driver fitted
- 1.5 m flex & 3 pin plug
- Emergency option available

### DIMMING OPTIONS

- Trailing edge (excluding S9734/306L, S9734/612L)
- 1-10V analogue (excluding S9734/612L)
- DALI / DSI, digital

### INSTALLATION TYPES

- Standard metric T-Bar ceiling recessed installation  
Air Slot models to suit –/306, –/312 panel sizes
- Plaster ceiling recessed installation  
(S9704 Plaster ceiling frame required)

### IP RATING

- IP20 suitable for interior use only

Model No.	Input	Power	Lumen	CCT	Beam Angle	CRI	Fitting Colour	Dimensions L x W x H
S9734/306L/CW	240V	23W	1800lm	4000K	100°	>80	White	595 x 295 x 65 mm
S9734/312L/CW	240V	38W	3500lm	4000K	100°	>80	White	1195 x 295 x 65 mm
S9734/606L/CW	240V	38W	3500lm	4000K	100°	>80	White	595 x 595 x 65 mm
S9734/612L/CW	240V	55W	4800lm	4000K	100°	>80	White	1195 x 595 x 65 mm

# LED TROFFER

## S9725 ORION

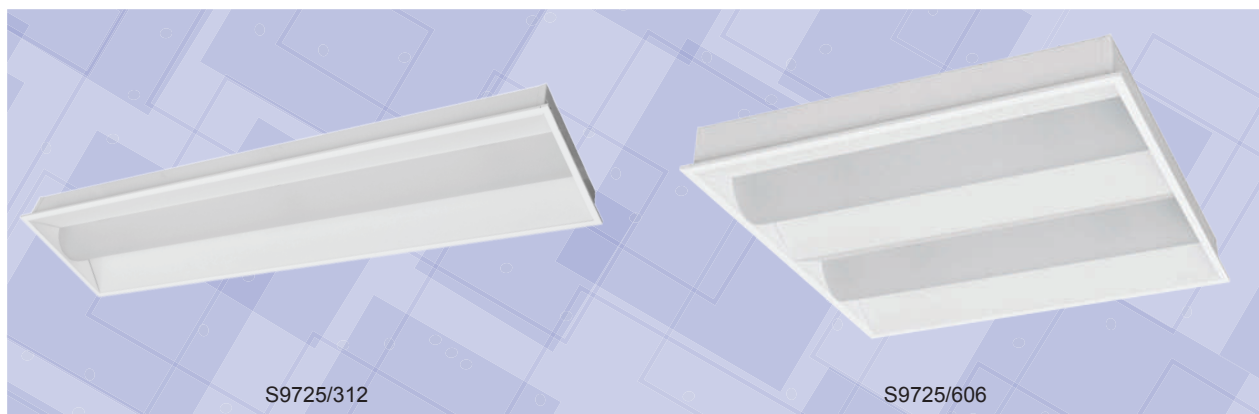

### DIMENSIONS

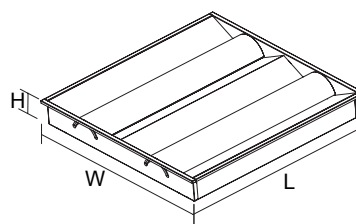
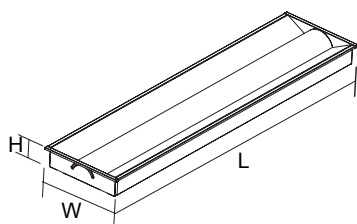

### CONSTRUCTION

- Robust steel body
- Matt white powder coated finish
- Opal acrylic diffuser
- High efficiency SMD LED chips
- Constant current non-dimmable LED driver fitted
- 1.2 m flex & 3 pin plug

### IP RATING

- IP20 suitable for interior use only

### DIMMING OPTIONS

- Trailing edge
- 1-10V analogue
- DALI / DSI, digital

### INSTALLATION TYPES

- Standard metric T-Bar ceiling recessed installation  
Air Slot models to suit –/312 panel sizes
- Plaster ceiling recessed installation  
(S9704 Plaster ceiling frame required)

Model No.	Input	Power	Lumen	CCT	Beam Angle	CRI	Fitting Colour	Dimensions L x W x H
S9725/312CW	240V	38W	3300lm	4000K	120°	>80	Matt White	1195 x 295 x 70 mm
S9725/606CW	240V	38W	3400lm	4000K	120°	>80	Matt White	595 x 595 x 70 mm



[www.sal.net.au](http://www.sal.net.au)

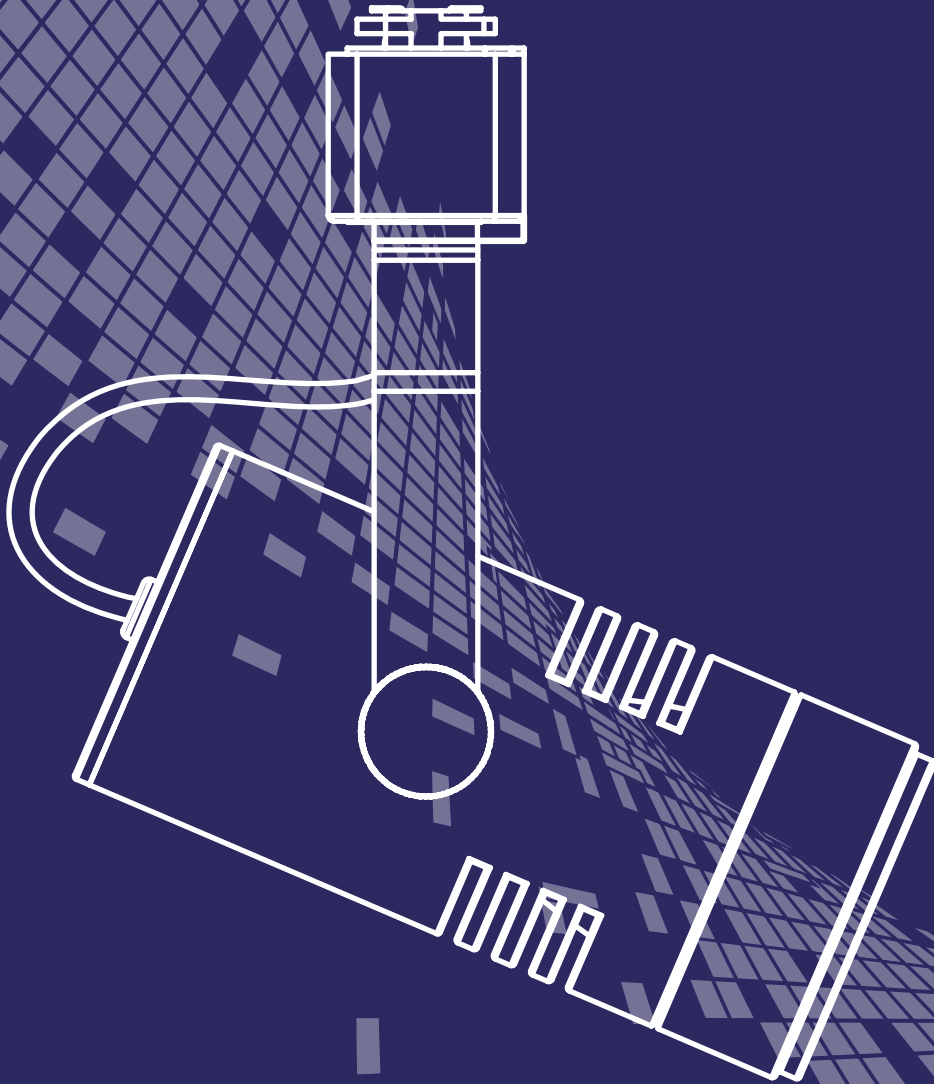



# LED TRACK LIGHTS

## NEW PRODUCTS



# SINGLE CIRCUIT TRACK

## STR4800/1, STR4800/2 UNIVERSAL

- Extruded aluminium profile
- Powder coated finish
- Length 1 m or 2 m
- Completed with end cap and live end

### IP RATING

- IP20 suitable for interior use only

### DIMENSIONS

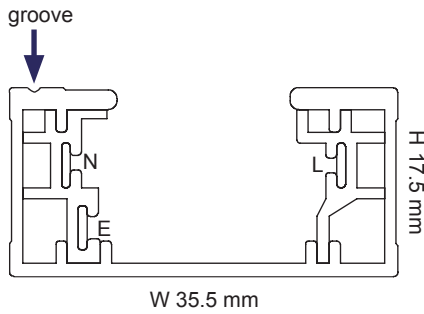

Model No.	Length	Colour
STR4800/1 WH	1 m	White
STR4800/1 SL	1 m	Silver
STR4800/1 BK	1 m	Black
STR4800/2 WH	2 m	White
STR4800/2 SL	2 m	Silver
STR4800/2 BK	2 m	Black

## TRACK COMPONENTS

### STRAIGHT JOINER

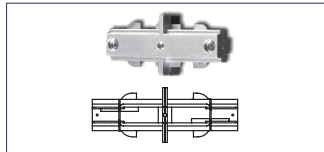

Model No.	Colour
STR4801 WH	White
STR4801 SL	Silver
STR4801 BK	Black

### T-SHAPED JOINER

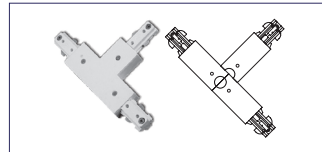

Model No.	Colour
STR4805 WH	White
STR4805 SL	Silver
STR4805 BK	Black

### LIVE END

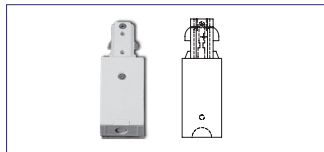

Model No.	Colour
STR4802 WH	White
STR4802 SL	Silver
STR4802 BK	Black

### CROSS JOINER

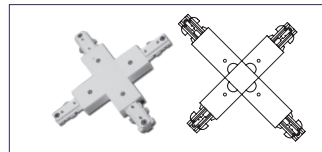

Model No.	Colour
STR4806 WH	White
STR4806 SL	Silver
STR4806 BK	Black

### LIVE CENTRE FEED

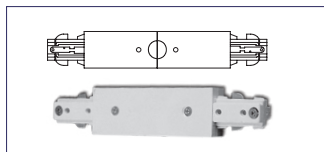

Model No.	Colour
STR4803 WH	White
STR4803 SL	Silver
STR4803 BK	Black

### TRACK ADAPTOR

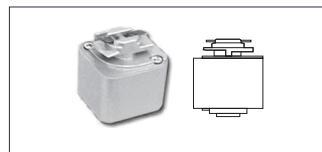

Model No.	Colour
STR4808 WH	White
STR4808 SL	Silver
STR4808 BK	Black

### L-SHAPED JOINER

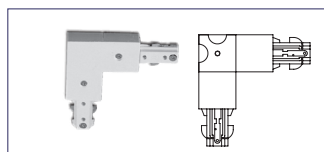

Model No.	Colour
STR4804 WH	White
STR4804 SL	Silver
STR4804 BK	Black

### SUSPENSION KIT

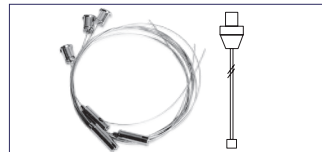

Model No.	Colour
SSI1512	Chrome

# SINGLE CIRCUIT TRACK DIAGRAM

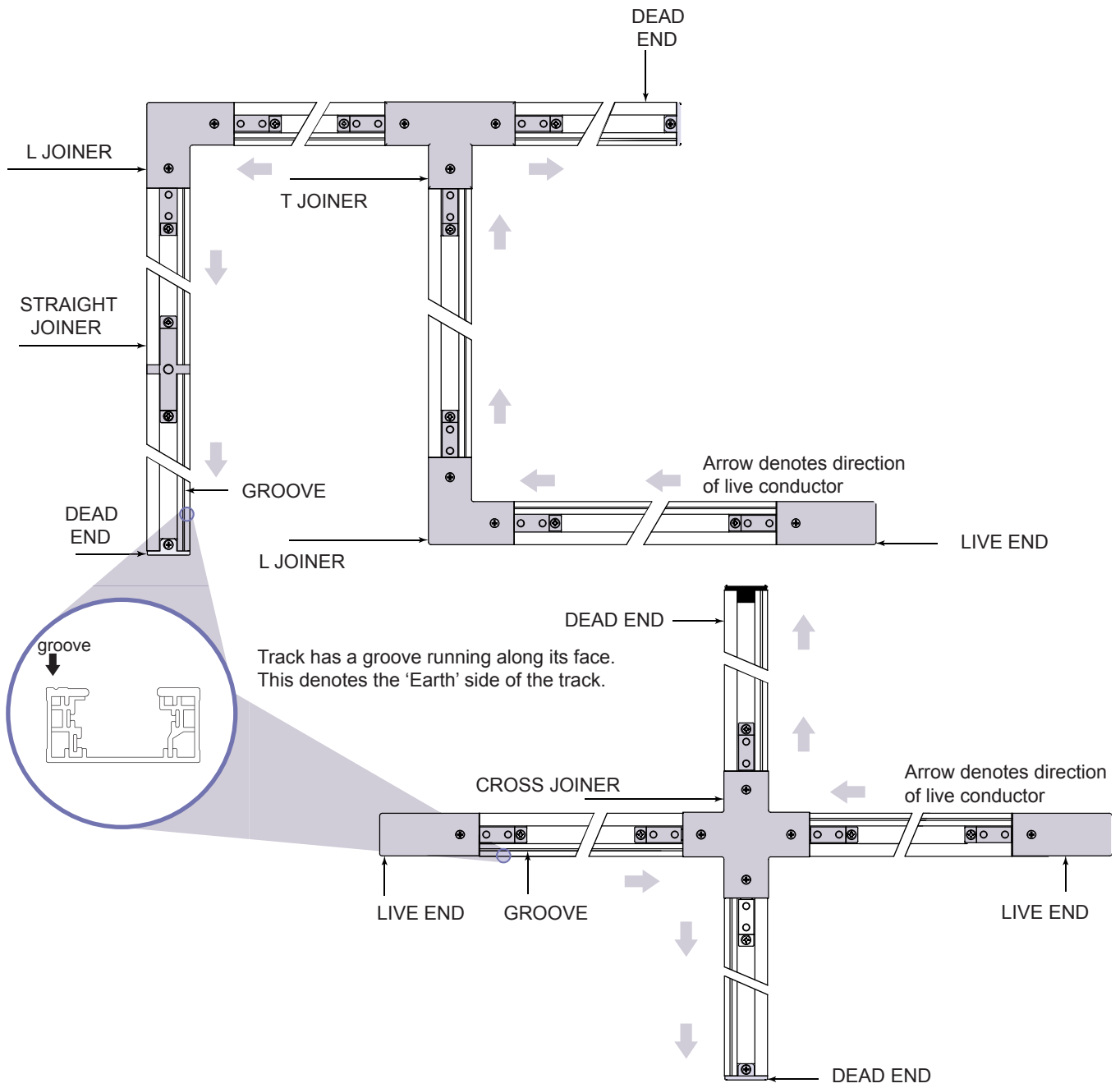

# SINGLE CIRCUIT LED TRACK LIGHT

## STR4855L, STR4856L SPOT I

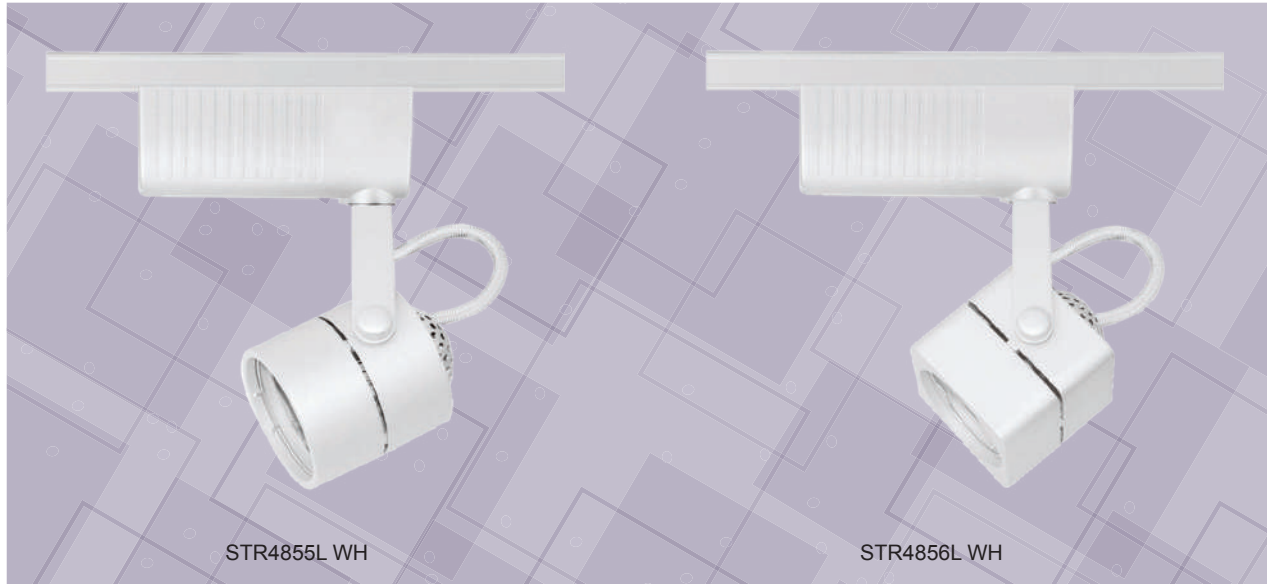
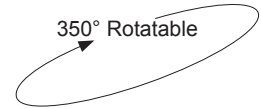

### DIMENSIONS



### CONSTRUCTION

- Die-cast aluminium body
- Powder coated finish
- Built-in 12V AC trailing edge dimmable transformer
- GU5.3 lamp base
- MR16 5W LED lamp included (non-dimmable)

### IP RATING

- IP20 suitable for interior use only

### LAMP OPTIONS

- MR16/7W
- MR16DIM9W

Model No.	Input	Power	Lumen	CCT	Beam Angle	CRI	Fitting Colour
STR4855L WH	240V	5W	350lm	3000K or 6000K	38°	>80	White
STR4855L SL	240V	5W	350lm	3000K or 6000K	38°	>80	Silver
STR4855L BK	240V	5W	350lm	3000K or 6000K	38°	>80	Black
STR4856L WH	240V	5W	350lm	3000K or 6000K	38°	>80	White
STR4856L SL	240V	5W	350lm	3000K or 6000K	38°	>80	Silver
STR4856L BK	240V	5W	350lm	3000K or 6000K	38°	>80	Black

# SINGLE CIRCUIT LED TRACK LIGHT

## STR4863GU SPOT II

## STR4863LV WH SPOT III

350° Rotatable



STR4863GU WH

STR4863LV WH

### DIMENSIONS

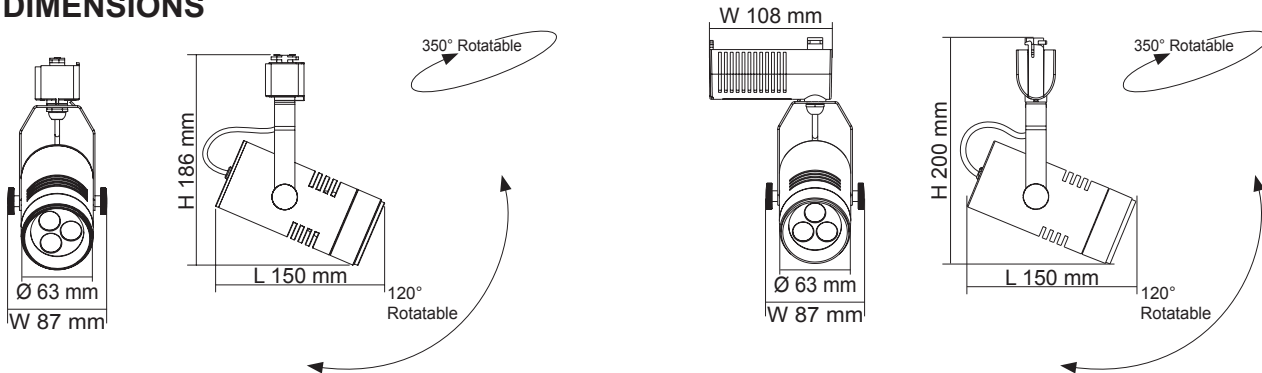

### CONSTRUCTION

- Die-cast aluminium body
- Powder coated finish

### STR4863LV

- Built-in 12V AC trailing edge dimmable transformer
- GU5.3 lamp base
- MR16 5W LED lamp included (non-dimmable)

### LAMP OPTIONS (STR4863LV)

- MR16/7W
- MR16DIM9W

### STR4863GU

- GU10 lamp base
- GU10L350 lamp included

### LAMP OPTIONS (STR4863GU)

- GU10L550
- GU10LR750
- GU10LA750 (trailing edge dimmable)

### IP RATING

- IP20 suitable for interior use only

Model No.	Input	Power	Lumen	CCT	Beam Angle	CRI	Fitting Colour
STR4863LV WH	240V	5W	350lm	3000K or 6000K	38°	>80	White
STR4863GU WH	240V	5W	350lm	3000K, 4000K or 6000K	38°	>80	White
STR4863GU BK	240V	5W	350lm	3000K, 4000K or 6000K	38°	>80	Black

# SINGLE CIRCUIT LED TRACK LIGHT

## STR4861 SPOTTY I



### DIMENSIONS

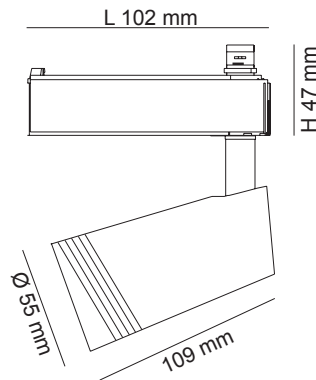

### CONSTRUCTION

- Die-cast aluminium body
- Powder coated finish
- High output COB LED chip
- Specially designed optical lens
- Built-in constant current non-dimmable LED driver

### IP RATING

- IP20 suitable for interior use only

### BEAM ANGLE

- 24° (standard)
- 36° (option)

Model No.	Input	Power	Lumen	CCT	Beam Angle	CRI	Fitting Colour
STR4861WW/WH	240V	6W	500lm	3000K	24°	>80	White
STR4861WW/BK	240V	6W	500lm	3000K	24°	>80	Black

### PHOTOMETRIC DATA

Unit: cd, B.A. 24° STR4861WW C0/C180 ——— C90/C270 ———

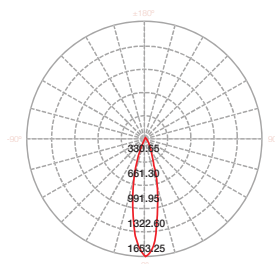



# SINGLE CIRCUIT LED TRACK LIGHT

## STR4866 SPOCK

350° Rotatable



### DIMENSIONS

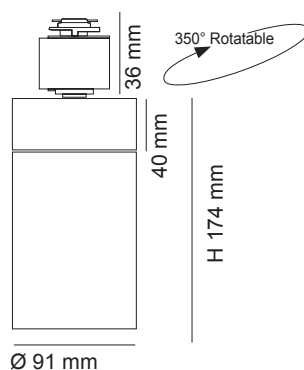

### CONSTRUCTION

- Premium aluminium body
- Powder coated finish
- High output COB LED chip
- High performance multi-reflector system
- Built-in constant current non-dimmable LED driver

### IP RATING

- IP20 suitable for interior use only

### BEAM ANGLE

- 24° reflector (standard)
- 45° reflector (option)

Model No.	Input	Power	Lumen	CCT	Beam Angle	CRI	Fitting Colour
STR4866CW/WH	240V	15W	1600lm	4000K	24°	>80	White
STR4866CW/BK	240V	15W	1600lm	4000K	24°	>80	Black
STR4866WW/WH	240V	15W	1600lm	3000K	24°	>80	White
STR4866WW/BK	240V	15W	1600lm	3000K	24°	>80	Black

**PHOTOMETRIC DATA** Unit: cd, B.A. 24° STR4866CW C0/C180 \_\_\_\_\_ C90/C270 \_\_\_\_\_

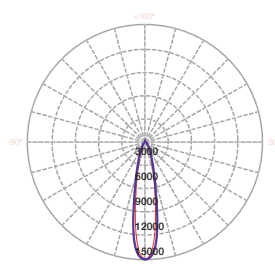

# THREE CIRCUIT TRACK

## STR4890 UNIVERSAL

- Extruded aluminium profile
- Powder coated finish
- Length 1 m or 2 m
- Completed with one end cap and live end

### IP RATING

- IP20 suitable for interior use only

### DIMENSIONS

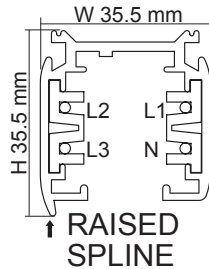

Model No.	Length	Colour
STR4890/1 WH	1 m	White
STR4890/1 BK	1 m	Black
STR4890/2 WH	2 m	White
STR4890/2 BK	2 m	Black

## TRACK COMPONENTS

### MINI JOINER



Model No.	Colour
STR4891 WH	White
STR4891 BK	Black

### LIVE END

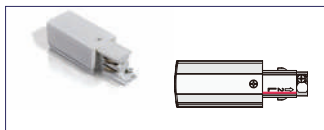

Model No.	Colour
STR4892 WH	White
STR4892 BK	Black

### STRAIGHT CONNECTOR

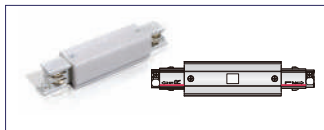

Model No.	Colour
STR4893 WH	White
STR4893 BK	Black

### L-SHAPED CONNECTOR

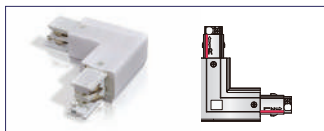

Model No.	Colour
STR4894 WH	White
STR4894 BK	Black

### T-SHAPED CONNECTOR

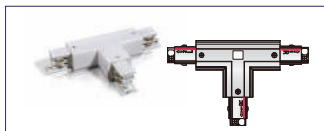

Model No.	Colour
STR4895 WH	White
STR4895 BK	Black

### CROSS SHAPED CONNECTOR

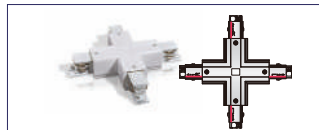

Model No.	Colour
STR4896 WH	White
STR4896 BK	Black

### ADJUSTABLE CONNECTOR

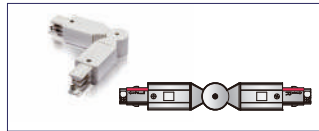

Model No.	Colour
STR4897 WH	White
STR4897 BK	Black

### 3 CIRCUITS ADAPTOR



Model No.	Colour
STR4898 WH	White
STR4898 BK	Black

### T-BAR MOUNTING KIT



Model No.	Colour
STR4899/1 WH	White
STR4899/1 BK	Black

### SUSPENSION UNIT WITH ROD

(M6 x 1000 mm threaded rod)



Model No.	Colour
STR4899/2 WH	White
STR4899/2 BK	Black

### SUSPENSION UNIT WITH WIRE

(Ø1.5 mm x 1500 mm wire)



Model No.	Colour
STR4899/3 WH	White
STR4899/3 BK	Black

# THREE CIRCUIT TRACK DIAGRAM

Track has a raised spline running along one side and track components all have an arrow on one side. To assemble, insert each component into the track so that the arrow is on the same side as the raised spline.

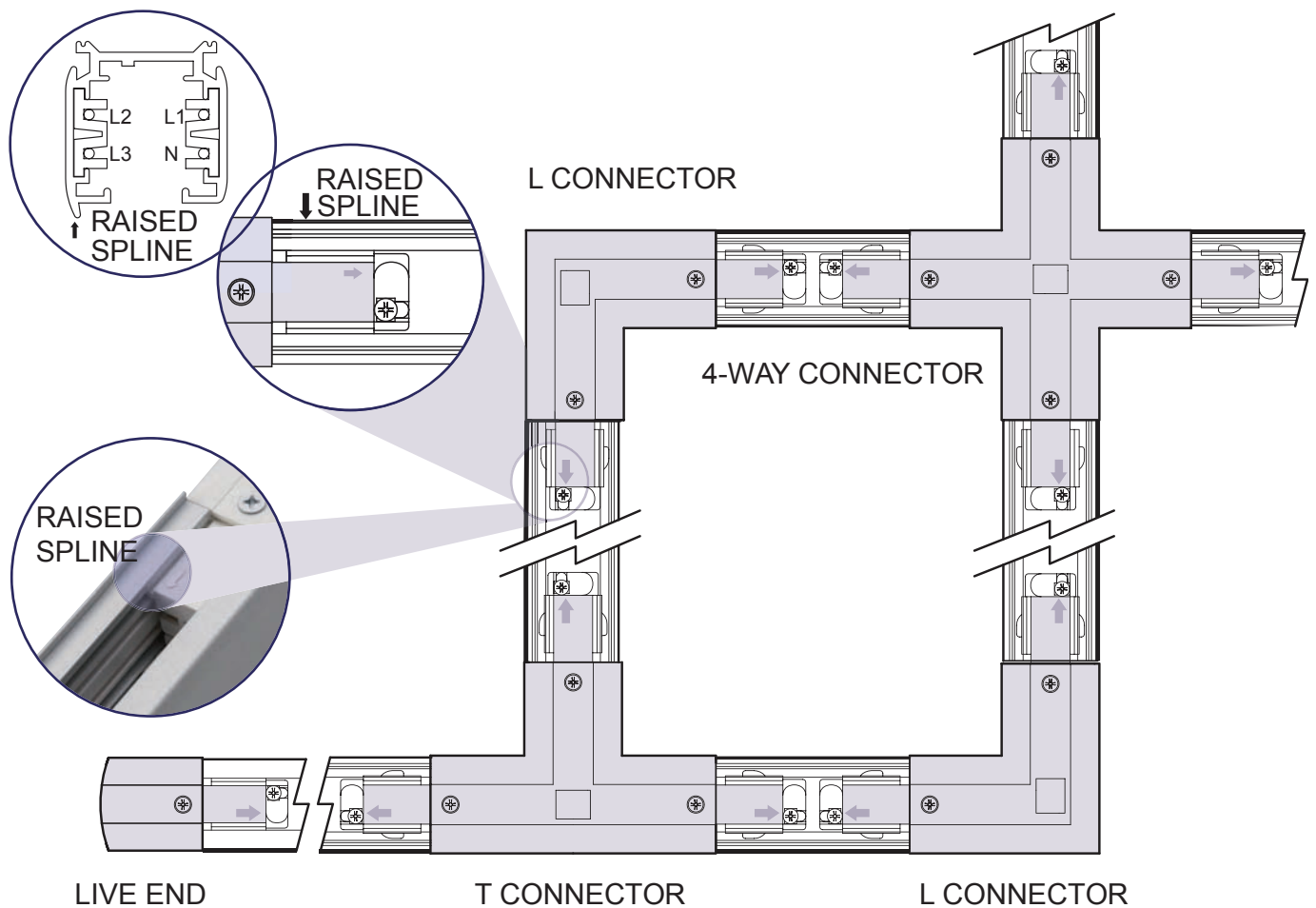

# THREE CIRCUIT LED TRACK LIGHT

## STR4881 UNIVERSAL I

330° Rotatable

### CONSTRUCTION

- Die-cast aluminium body
- Powder coated finish
- Clear tempered glass cover
- High output COB LED chip
- High performance multi-reflector system
- Built-in constant current non-dimmable LED driver

### IP RATING

- IP20 suitable for interior use only

### BEAM ANGLE

- 24° (standard)
- 14°, 18°, 36° (option)



### DIMENSIONS

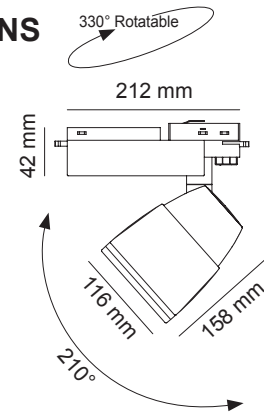

Model No.	Input	Power	Lumen	CCT	Beam Angle	CRI	Fitting Colour
STR4881/30BK WW 24 DG	240V	30W	2600lm	3000K	24°	>80	Black
STR4881/30BK CW 24 DG	240V	30W	2600lm	4000K	24°	>80	Black
STR4881/30WH WW 24 DG	240V	30W	2600lm	3000K	24°	>80	White
STR4881/30WH CW 24 DG	240V	30W	2600lm	4000K	24°	>80	White
STR4881/50BK WW 24 DG	240V	50W	4200lm	3000K	24°	>80	Black
STR4881/50BK CW 24 DG	240V	50W	4200lm	4000K	24°	>80	Black
STR4881/50WH WW 24 DG	240V	50W	4200lm	3000K	24°	>80	White
STR4881/50WH CW 24 DG	240V	50W	4200lm	4000K	24°	>80	White

### PHOTOMETRIC DATA Unit: cd STR4881/50 WW 3000K C0/C180

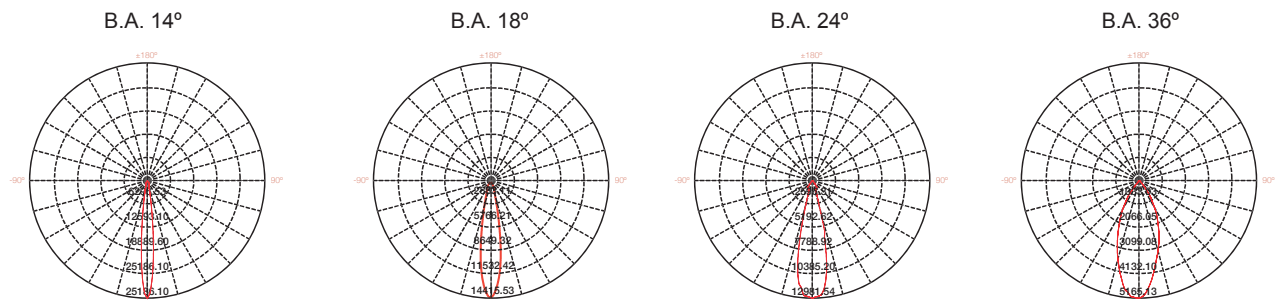

# THREE CIRCUIT LED TRACK LIGHT

## STR4882 UNIVERSAL II

## STR4883 UNIVERSAL III

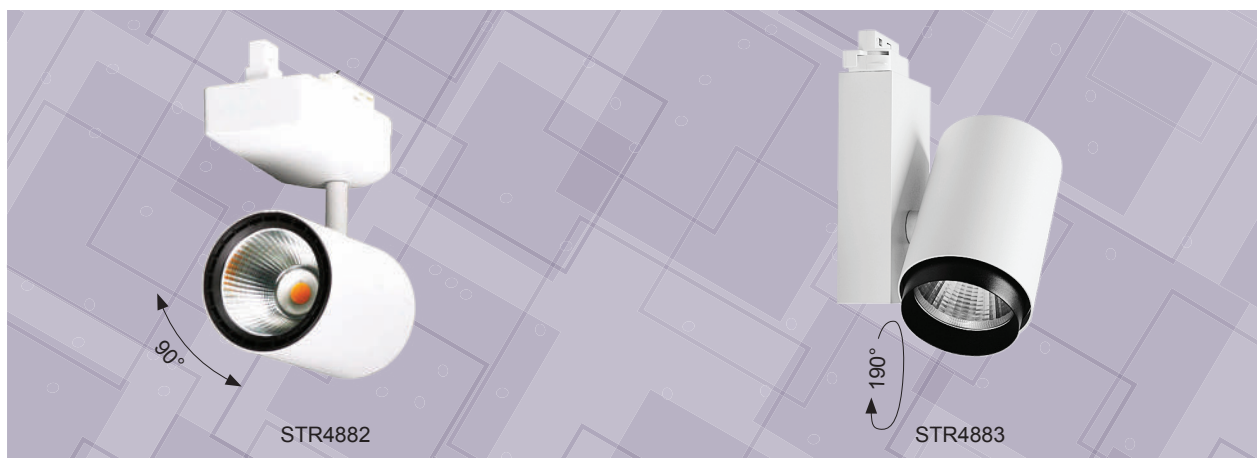
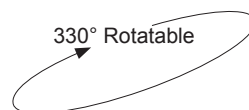

### DIMENSIONS

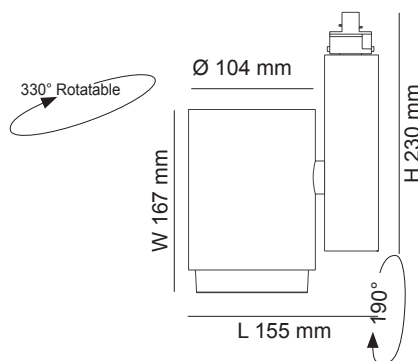
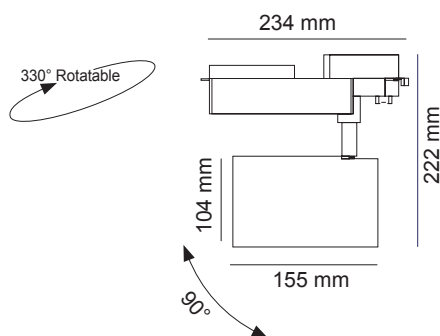

### CONSTRUCTION

- Extruded aluminium body
- Powder coated finish
- Clear tempered glass cover
- High output COB LED chip
- High performance multi-reflector system
- Built-in constant current non-dimmable LED driver

### IP RATING

- IP20 suitable for interior use only

### BEAM ANGLE

- 36° (standard)
- 24° (option)

Model No.	Input	Power	Lumen	CCT	Beam Angle	CRI	Fitting Colour
STR4882/36 WH WW	240V	36W	3280lm	3000K	36°	>84	White
STR4882/36 BK WW	240V	36W	3280lm	3000K	36°	>84	Black
STR4883WW/WH	240V	36W	3280lm	3000K	36°	>80	White
STR4883WW/BK	240V	36W	3280lm	3000K	36°	>80	Black

### PHOTOMETRIC DATA

Unit: cd, C0/C180 \_\_\_\_\_ C90/C270 \_\_\_\_\_

STR4882/36 WW B.A. 36° 3000K

STR4883WW B.A. 36° 3000K

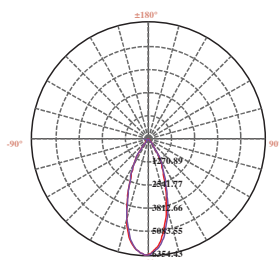
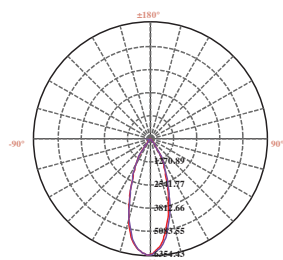

Specifications above are for reference only and may vary without prior notice



# THREE CIRCUIT LED TRACK LIGHT

## STR4886 SPOCK

350° Rotatable



### DIMENSIONS

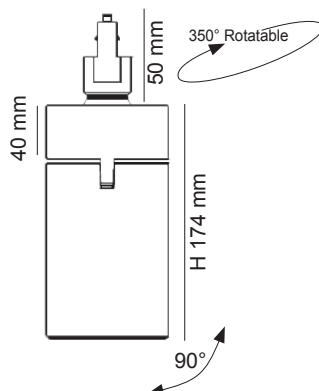

### CONSTRUCTION

- Premium aluminium body
- Powder coated finish
- Clear tempered glass cover
- High output COB LED chip
- High performance multi-reflector system
- Built-in constant current non-dimmable LED driver

### IP RATING

- IP20 suitable for interior use only

### BEAM ANGLE

- 24° reflector (standard)
- 45° reflector (option)

Model No.	Input	Power	Lumen	CCT	Beam Angle	CRI	Fitting Colour
STR4886WW/WH	240V	30W	2600lm	3000K	24°	>80	White
STR4886WW/BK	240V	30W	2600lm	3000K	24°	>80	Black

**PHOTOMETRIC DATA** Unit: cd, B.A. 24° STR4886WW C0/C180 \_\_\_\_\_ C90/C270 \_\_\_\_\_

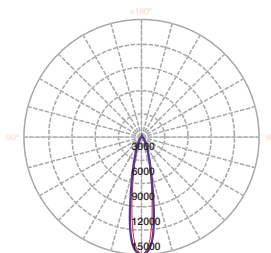



# THREE CIRCUIT LED TRACK LIGHT

## STR3/4863GU SPOT IV

350° Rotatable

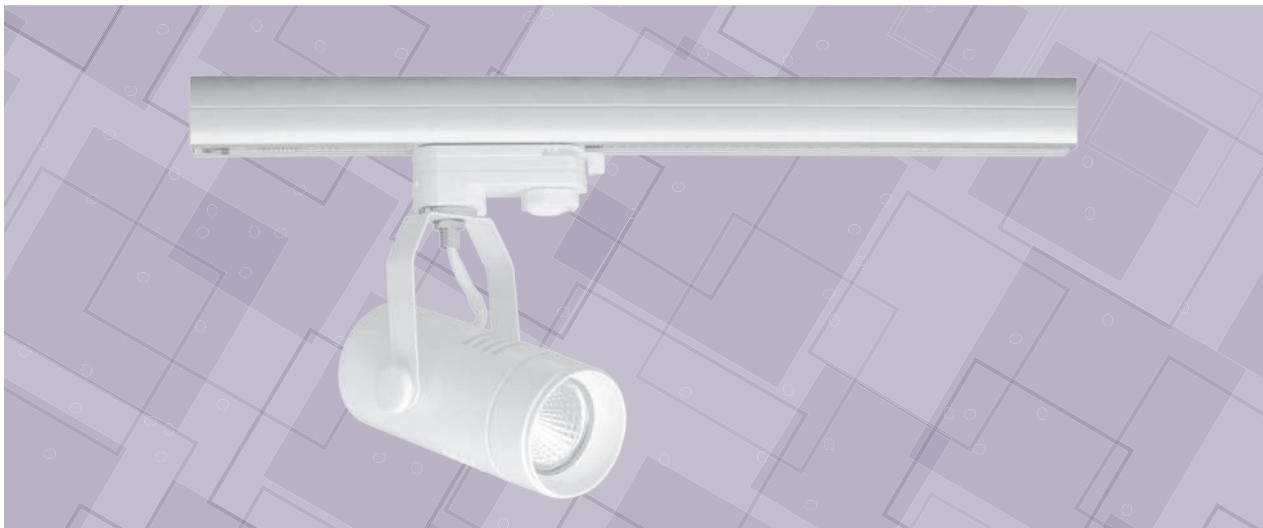

### DIMENSIONS

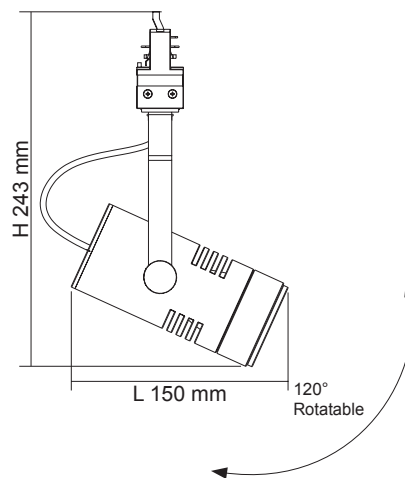
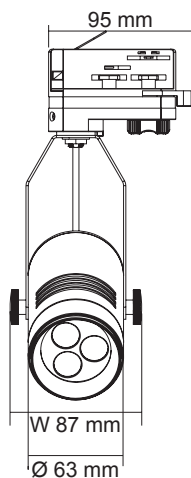

### CONSTRUCTION

- Die-cast aluminium body
- Powder coated finish
- GU10 lamp base
- GU10L350 lamp included

### LAMP OPTIONS

- GU10L550
- GU10LR750
- GU10LA750 (trailing edge dimmable)

### IP RATING

- IP20 suitable for interior use only

Model No.	Input	Power	Lumen	CCT	Beam Angle	CRI	Fitting Colour
STR3/4863GU WH	240V	5W	350lm	3000K, 4000K or 6000K	38°	>80	White
STR3/4863GU BK	240V	5W	350lm	3000K, 4000K or 6000K	38°	>80	Black

# LED TRACK

## SINGLE CIRCUIT STR9017 UNITREK

## THREE CIRCUIT STR3/9017 UNITREK

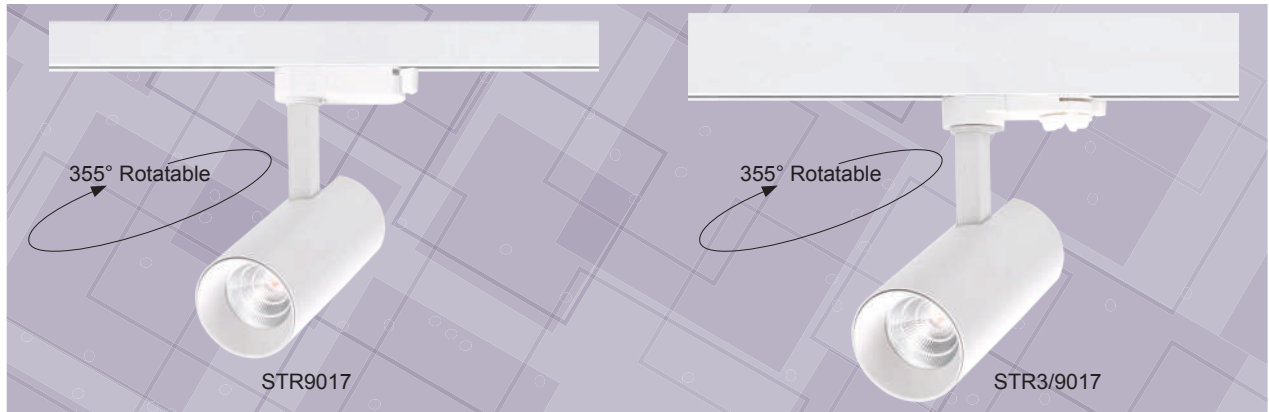

### DIMENSIONS

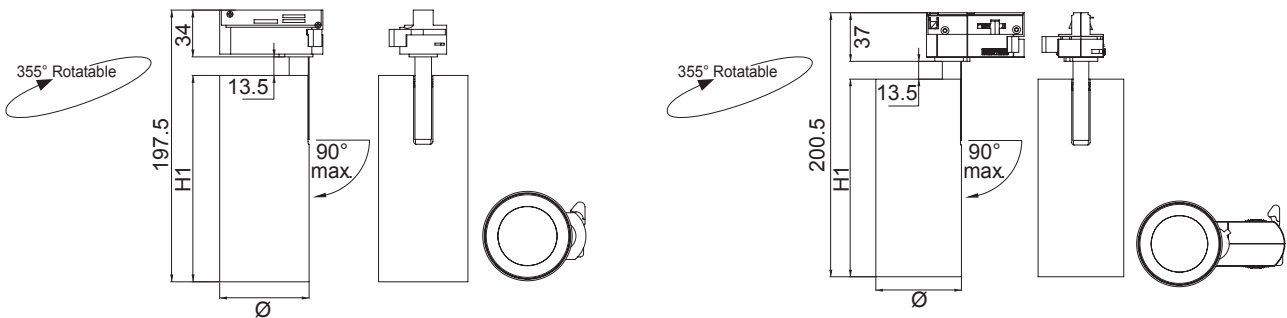

### CONSTRUCTION

- Architectural cylindrical profile
- Die-cast aluminium body
- High efficiency COB LED chip
- Changeable multi-reflector system
- Polycarbonate optical lens
- Built-in constant current trailing edge dimmable LED driver

### IP RATING

- IP20 suitable for interior use only

### FITTING COLOUR

- Matt white (standard), Black (option)

### BEAM ANGLE

- 60° (standard)
- 25° optical reflector (option)
- 40° optical reflector (option)

Model No.	Input	Power	Lumen	CCT	Beam Angle	CRI	Fitting Colour	Dimension Ø x H1
STR9017WW/WH	240V	9W	700lm	3000K	60°	>80	Matt White	65 x 150 mm
STR9017CW/WH	240V	9W	800lm	4000K	60°	>80	Matt White	65 x 150 mm
STR9017DL/WH	240V	9W	800lm	6000K	60°	>80	Matt White	65 x 150 mm
STR3/9017WW/WH	240V	9W	700lm	3000K	60°	>80	Matt White	65 x 150 mm
STR3/9017CW/WH	240V	9W	800lm	4000K	60°	>80	Matt White	65 x 150 mm
STR3/9017DL/WH	240V	9W	800lm	6000K	60°	>80	Matt White	65 x 150 mm

### PHOTOMETRIC DATA Unit: cd C0/C180 — C90/C270 STR9017WW, STR3/9017WW

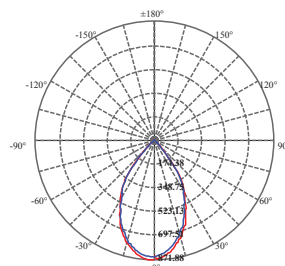

# LED SPOT LIGHT SURFACE MOUNTED **SMT9017 UNITREK** RECESSED **SRC9017 UNITREK**

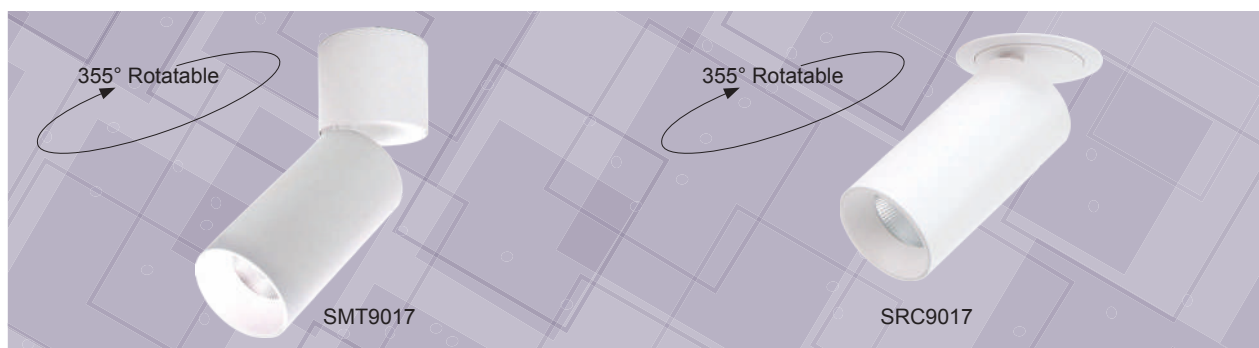

## DIMENSIONS

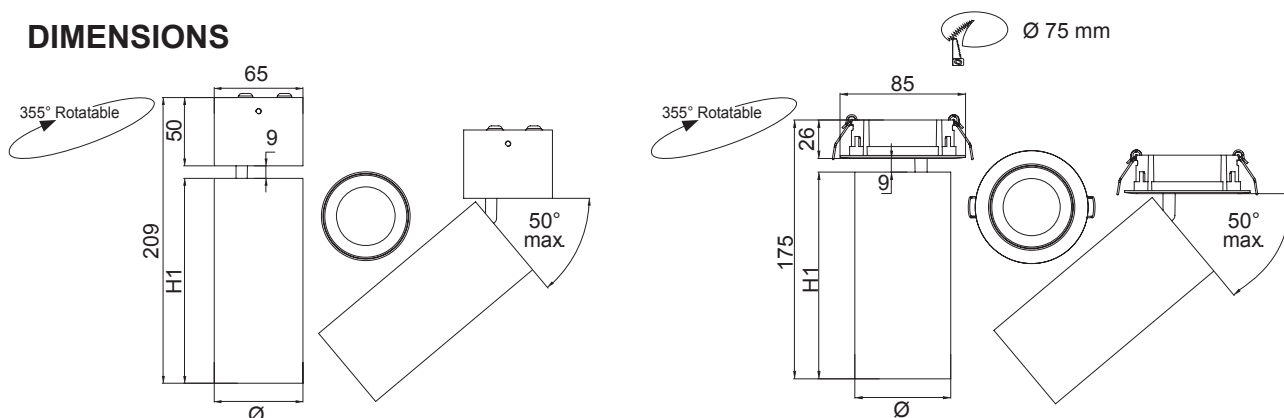

## CONSTRUCTION

- Architectural cylindrical profile
- Die-cast aluminium body
- High efficiency COB LED chip
- Changeable multi-reflector system
- Polycarbonate optical lens
- Built-in constant current trailing edge dimmable LED driver

## IP RATING

- IP20 suitable for interior use only

## FITTING COLOUR

- Matt white (standard), Black (option)

## BEAM ANGLE

- 60° (standard)
- 25° optical reflector (option)
- 40° optical reflector (option)

Model No.	Input	Power	Lumen	CCT	Beam Angle	CRI	Fitting Colour	Cut out Ø	Dimension Ø x H1
SMT9017WW/WH	240V	9W	700lm	3000K	60°	>80	White	—	65 x 150 mm
SMT9017CW/WH	240V	9W	800lm	4000K	60°	>80	White	—	65 x 150 mm
SMT9017DL/WH	240V	9W	800lm	6000K	60°	>80	White	—	65 x 150 mm
SRC9017WW/WH	240V	9W	700lm	3000K	60°	>80	White	75 mm	65 x 140 mm
SRC9017CW/WH	240V	9W	800lm	4000K	60°	>80	White	75 mm	65 x 140 mm
SRC9017DL/WH	240V	9W	800lm	6000K	60°	>80	White	75 mm	65 x 140 mm

## PHOTOMETRIC DATA Unit: cd C0/C180 — C90/C270 — SMT9017WW, SRC9017WW

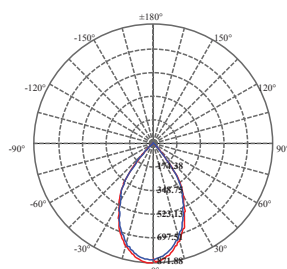

Dimmer/Switch  
Compatible



www.sal.net.au



[www.sal.net.au](http://www.sal.net.au)



# LED STRIPS

## NEW PRODUCTS



# LED STRIP RANGE

## 12V LOW VOLTAGE LED STRIP

Type	Voltage	CCT / Colour	Power	IP Rating	Width	Roll Length	Page Reference
FL1209/S	12V DC	WW, CW, DL	9W/m	IP44	10 mm	5 m	Page 162
FL1209/SR	12V DC	WW, CW, DL	9W/m	IP67	12 mm	5 m	Page 162
FL1206/S	12V DC	RED, GREEN, BLUE	6W/m	IP44	10 mm	5 m	Page 163

## 12V LOW VOLTAGE LED STRIP KIT

Type	Voltage	CCT / Colour	Power	IP Rating	Width	Roll Length	Page Reference
FLP12V2M/S	12V DC	WW, NDL	6W/m	IP44	8 mm	2 m	Page 164
FLP12V5M/S	12V DC	WW, NDL	6W/m	IP44	8 mm	5 m	Page 164
FLP12V5M/RGB	12V DC	RGB	6W/m	IP44	10 mm	5 m	Page 165

## 12V LOW VOLTAGE SMART LED STRIP KIT

Type	Voltage	CCT / Colour	Power	IP Rating	Width	Roll Length	Page Reference
FLP12V2M/SBT	12V DC	WW, NDL	6W/m	IP44	8 mm	2 m	Page 306
FLP12V5M/SBT	12V DC	WW, NDL	6W/m	IP44	8 mm	5 m	Page 306
FLP12V2M/RGBBT	12V DC	RGB	6W/m	IP44	10 mm	2 m	Page 307
FLP12V5M/RGBBT	12V DC	RGB	6W/m	IP44	10 mm	5 m	Page 307

## 24V LOW VOLTAGE LED STRIP

Type	Voltage	CCT / Colour	Power	IP Rating	Width	Roll Length	Page Reference
FL2406/R05	24V DC	WW, NDL, BLUE	6W/m	IP20	5 mm	30 m	Page 166
FL2406/SS10	24V DC	WW, CW, DL	6W/m	IP65	10 mm	20 m	Page 167
FL2412/SS10	24V DC	WW, CW, DL	12W/m	IP65	10 mm	20 m	Page 167
FLH2420	24V DC	WW, CW, DL	20W/m	IP20	8 mm	5 m	Page 168
FL2415RGB/S	24V DC	RGB	15W/m	IP44	10 mm	6 m	Page 169

WW	Warm White	3000K
CW	Cool White	4000K
NDL	Neutral Daylight	5000K
DL	Daylight	6000K
RGB	Colour selectable	



# LED STRIP WITH CONTROLLER WIRING DIAGRAM

## SINGLE COLOUR LED STRIP DIMMING WIRING DIAGRAM

### TYPE A (TRAILING EDGE)

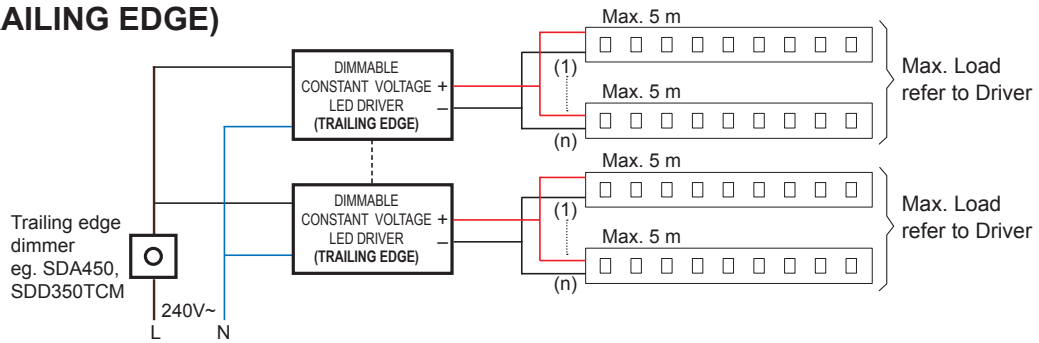

### TYPE B (LED CONTROLLER)

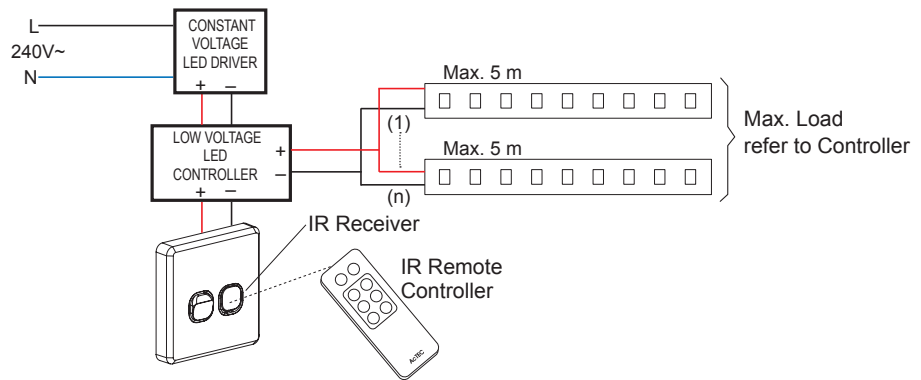

### TYPE C (1 – 10V)

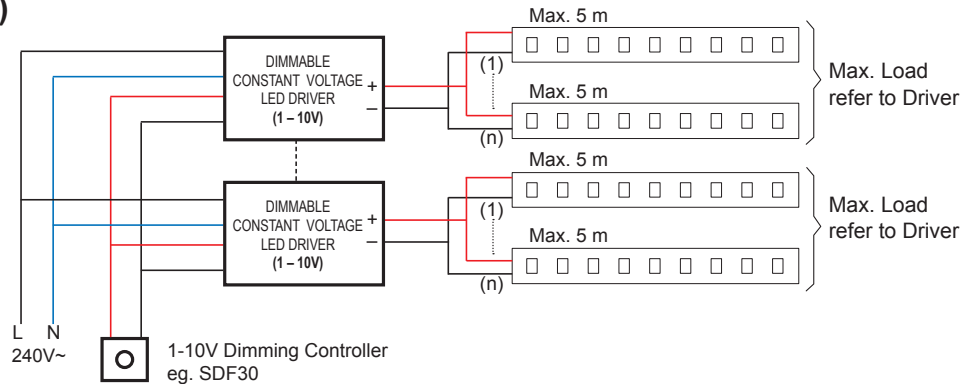

## RGB LED STRIP WIRING DIAGRAM

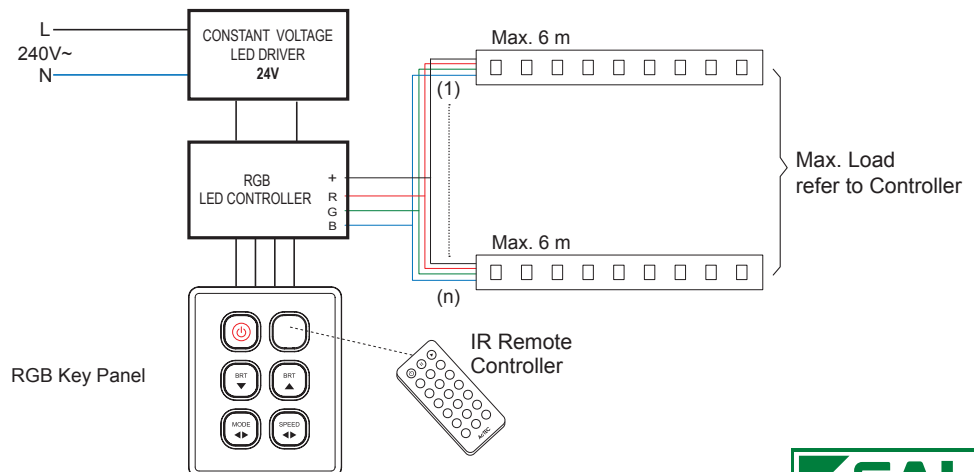

# 12V LOW VOLTAGE LED STRIP IP44

## FL1209/S

# 12V LOW VOLTAGE LED STRIP IP67

## FL1209/SR

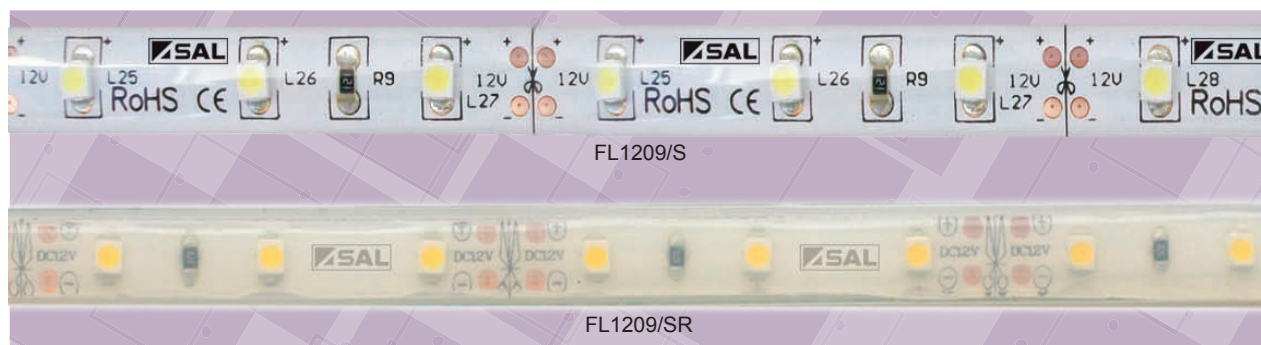

### DIMENSIONS

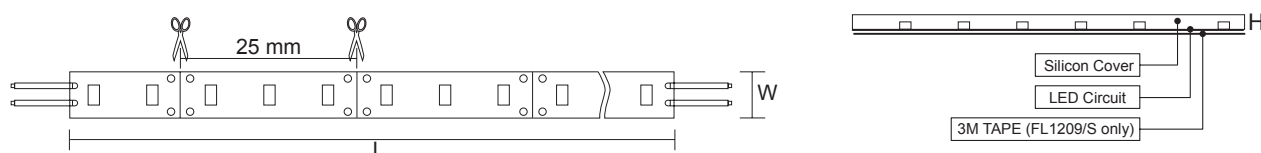

### CONSTRUCTION

- High efficiency SMD LED chips
- Silicon covered
- Max. roll length 5 m, cuttable every 25 mm at scissors symbol ✂
- Connection length can be extended by certain LED drivers, controllers and repeaters
- Dimmable with compatible controller or dimmable constant voltage LED driver
- Heat sink and 12V constant voltage LED driver required

### IP RATING (FL1209/S)

- IP44

### IP RATING (FL1209/SR)

- IP67

### SUITABLE LED DRIVER

- Refer to Constant Voltage LED Driver & Dimmable Constant Voltage LED Driver section in the catalogue

### FL1209/S – LED CHANNEL/ HEATSINK

**LED Channel options:** SLT1000, SLT3000, SLT3010, SLT3020, SLT3030, SLT3040, SLT3050, SLT4050, SLT5000

### FL1209/SR – SUFFICIENT HEATSINK REQUIRED

### DIMMING OPTIONS

#### TYPE A

- Trailing edge dimming

#### TYPE B

- LED Controller: LT8903DIM, LT8905DIM and LT8904DIM/RP

#### TYPE C

- 1-10V analogue

Model No.	Input	Power	Lumen	Colour Temp	Beam Angle	CRI (Ra)	Cutttable Length	Dimensions W x H	IP Rating	LED Quantity
FL1209WW/S	12V DC	9W/m	600lm/m	3000K	115°	>80	25 mm	10 x 3 mm	IP44	120/m
FL1209CW/S	12V DC	9W/m	600lm/m	4000K	115°	>80	25 mm	10 x 3 mm	IP44	120/m
FL1209DL/S	12V DC	9W/m	600lm/m	6000K	115°	>80	25 mm	10 x 3 mm	IP44	120/m
FL1209WW/SR	12V DC	9W/m	500lm/m	3000K	115°	>80	25 mm	12 x 4.5 mm	IP67	120/m
FL1209CW/SR	12V DC	9W/m	500lm/m	4000K	115°	>80	25 mm	12 x 4.5 mm	IP67	120/m
FL1209DL/SR	12V DC	9W/m	500lm/m	6000K	115°	>80	25 mm	12 x 4.5 mm	IP67	120/m

# 12V LOW VOLTAGE SINGLE COLOUR LED STRIP IP44

## FL1206/S

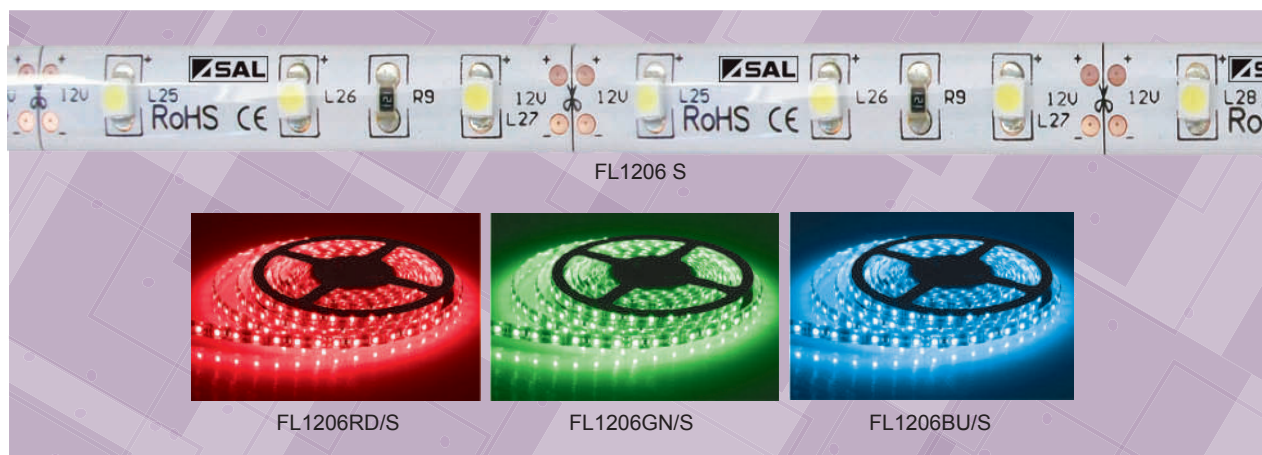

### DIMENSIONS

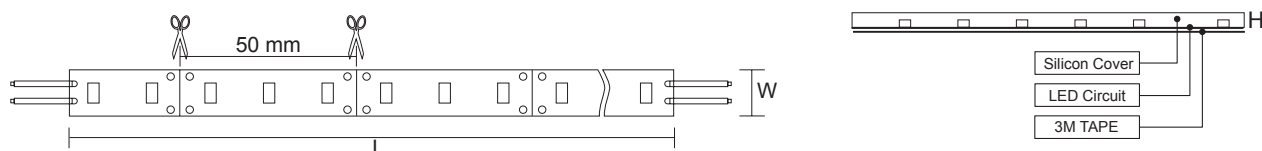

### CONSTRUCTION

- High efficiency SMD LED chips with 3M self-adhesive tapes at back
- Silicon covered
- Stable working performance and even light output
- Max. roll length 5 m, cuttable every 50 mm at scissors symbol ✂
- Connection length can be extended by certain LED drivers, controllers and repeaters
- Dimmable with compatible controller
- Heat sink and 12V constant voltage LED driver required
- LED colours: Red, Green, Blue

### IP RATING

- IP44

### SUITABLE LED DRIVER

- Refer to Constant Voltage LED Driver & Dimmable Constant Voltage LED Driver section in the catalogue

### LED CHANNEL/ HEATSINK

**LED Channel options:** SLT1000, SLT3000, SLT3010, SLT3020, SLT3030, SLT3040, SLT3050, SLT4050, SLT5000

### DIMMING OPTIONS

#### TYPE A

- Trailing edge dimming

#### TYPE B

- LED Controller: LT8903DIM, LT8905DIM and LT8904DIM/RP

#### TYPE C

- 1-10V analogue

Model No.	Input	Power	Lumen	Colour Temp	Beam Angle	Cutttable Length	Dimensions W x H	IP Rating	LED Quantity
FL1206RD/S	12V DC	6W/m	120lm/m	Red	115°	50 mm	10 x 3.5 mm	IP44	60/m
FL1206GN/S	12V DC	6W/m	180lm/m	Green	115°	50 mm	10 x 3.5 mm	IP44	60/m
FL1206BU/S	12V DC	6W/m	60lm/m	Blue	115°	50 mm	10 x 3.5 mm	IP44	60/m

# 12V LOW VOLTAGE LED STRIP KIT

## FLP12V2M/S, FLP12V5M/S



### DIMENSIONS

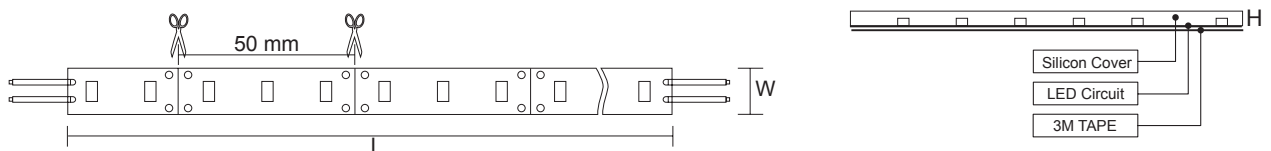

### CONSTRUCTION

- 12V weatherproof LED flexible strip with 3M self-adhesive tapes at back
- Pre-wired strip kit includes LED driver, LED strip & 1.2 m flex & 2 pin plug
- Plug in & ready to use
- High efficiency SMD LED chips
- Silicon covered
- Stable working performance and even light output
- Cuttable every 50 mm at the scissors symbol ✂
- Heatsink recommended
- 2M or 5M kits available

### IP RATING

- IP44 weatherproof strip
- IP20 flex, plug & driver

### LED CHANNEL OPTIONS

SLT1000, SLT3000, SLT3010, SLT3020, SLT3030, SLT3040, SLT3050, SLT4050, SLT5000

**PIXIE Models available. Refer to page 306 in the SMART LIGHTING section of this catalogue.**

Model No.	Input	Power	Lumen	Colour Temp	Beam Angle	CRI (Ra)	Cuttable Length	Dimensions L x W x H	LED Quantity
FLP12V2M/WW/S	240V	6W/m	300lm/m	3000K	115°	>80	50 mm	2000 x 8 x 2.5 mm	60/m
FLP12V2M/NDL/S	240V	6W/m	300lm/m	5000K	115°	>80	50 mm	2000 x 8 x 2.5 mm	60/m
FLP12V5M/WW/S	240V	6W/m	300lm/m	3000K	115°	>80	50 mm	5000 x 8 x 2.5 mm	60/m
FLP12V5M/NDL/S	240V	6W/m	300lm/m	5000K	115°	>80	50 mm	5000 x 8 x 2.5 mm	60/m



FLP12V5M/WW/S



FLP12V2M/WW/S



FLP12V5M/DL/S



FLP12V2M/DL/S

# 12V LOW VOLTAGE RGB LED STRIP KIT

## FLP12V5M/RGB



### DIMENSIONS

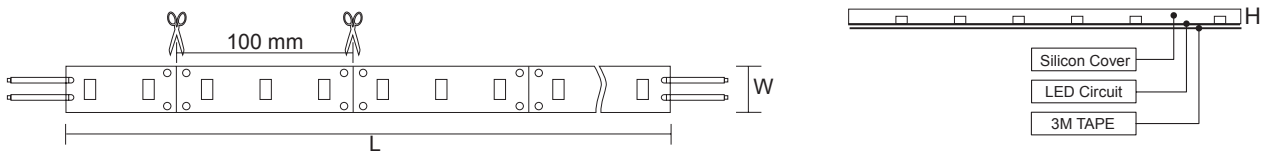

### CONSTRUCTION

- 12V weatherproof LED flexible strip with 3M self-adhesive tapes at back
- Pre-wired strip kit includes LED driver, LED strip & 1.2 m flex & 2 pin plug
- Plug in & ready to use
- High efficiency SMD LED chips
- Silicon covered
- Cuttable every 100 mm at the scissors symbol ✂
- Heatsink recommended
- RGB colour changeable (20 options)
- Multi-function remote controller included

### IP RATING

- IP44 weatherproof strip
- IP20 flex, plug & driver

### LED CHANNEL OPTIONS

SLT1000, SLT3000, SLT3010, SLT3020, SLT3030, SLT3040, SLT3050, SLT4050, SLT5000

**PIXIE Models** available. Refer to page 307 in the **SMART LIGHTING** section of this catalogue.

Model No.	Input	Power	Lumen	Beam Angle	Cuttable Length	Dimensions L x W x H	LED Quantity
FLP12V5M/RGB	240V	6W/m	100lm/m	115°	100 mm	5000 x 10 x 3 mm	30/m



FLP12V5M/RGB



# 24V LOW VOLTAGE LED STRIP IP20

## FL2406/R05 FLEXI

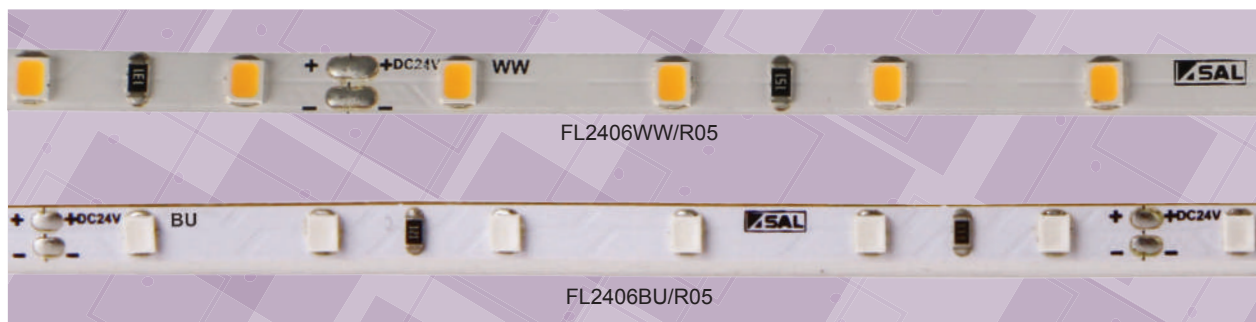

### DIMENSIONS

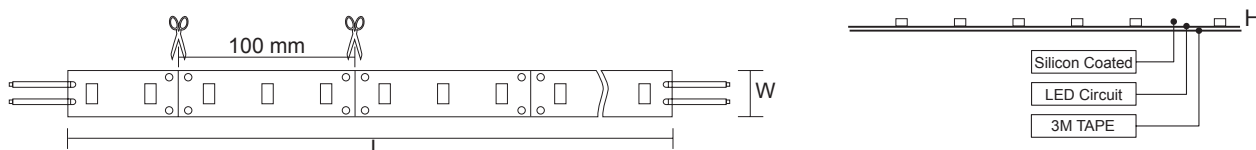

### CONSTRUCTION

- High efficiency SMD LED chips with 3M self-adhesive tapes at back
- Silicon coated
- Roll length 30 m, cuttable every 100 mm at scissors symbol ✂
- Connection length can be extended by certain LED drivers, controllers and repeaters
- Dimmable with compatible controller or dimmable constant voltage LED driver
- Heatsink recommended
- 24V Constant Voltage LED driver required

### IP RATING

- IP20 suitable for interior use only

### SUITABLE LED DRIVER

- Refer to Constant Voltage LED Driver & Dimmable Constant Voltage LED Driver section in the catalogue

### LED CHANNEL OPTIONS

SLT1000, SLT3000, SLT3010, SLT3020, SLT3030, SLT3040, SLT3050, SLT4050, SLT5000, SLT6000, SLT6010, SLT6050

### DIMMING OPTIONS

#### TYPE A

- Trailing edge dimming

#### TYPE B

- LED Controller: LT8903DIM, LT8905DIM and LT8904DIM/RP

#### TYPE C

- 1-10V analogue

### WIRING DIAGRAM



Model No.	Input	Power	Lumen	Colour Temp	Beam Angle	CRI (Ra)	Cuttable Length	Dimensions W x H	LED Quantity	Max. Length per run
FL2406WW/R05	24V DC	6W/m	460lm/m	3000K	115°	>80	100 mm	5 mm x 1.4 mm	60/m	5 m
FL2406NDL/R05	24V DC	6W/m	460lm/m	5000K	115°	>80	100 mm	5 mm x 1.4 mm	60/m	5 m
FL2406BU/R05	24V DC	6W/m	85lm/m	Blue	115°	-	100 mm	5 mm x 1.4 mm	60/m	5 m

### QUICK CONNECT KIT

Model No.	Description
FLC05CS	Twin 400mm fly lead to connect 5 mm strip (pack of 10)





# 24V LOW VOLTAGE LED STRIP IP65

## FL2406/SS10, FL2412/SS10 FLEXI



### DIMENSIONS

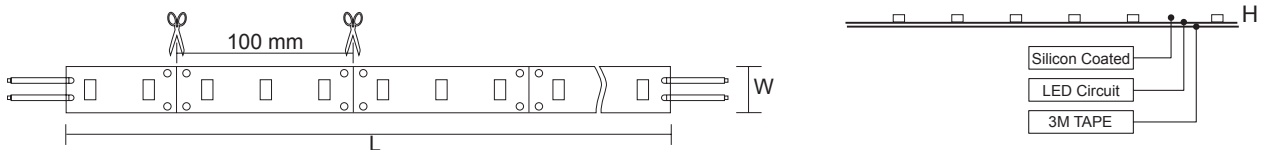

### CONSTRUCTION

- High efficiency SMD LED chips with 3M self-adhesive tapes at back
- Silicon coated
- Roll length 20 m, cuttable every 100 mm at scissors symbol ✂
- Connection length can be extended by certain LED drivers, controllers and repeaters
- Dimmable with compatible controller or dimmable constant voltage LED driver
- 24V Constant Voltage LED driver required
- Heatsink recommended (FL2406/SS10)
- Sufficient heatsink required (FL2412/SS10)

### IP RATING

- IP65 weatherproof

### SUITABLE LED DRIVER

- Refer to Constant Voltage LED Driver & Dimmable Constant Voltage LED Driver section in the catalogue

### LED CHANNEL OPTIONS

SLT1000, SLT3000, SLT3010, SLT3020, SLT3030, SLT3040, SLT3050, SLT4050, SLT5000

### DIMMING OPTIONS

#### TYPE A

- Trailing edge dimming

#### TYPE B

- LED Controller: LT8903DIM , LT8905DIM and LT8904DIM/RP

#### TYPE C

- 1-10V analogue

### WIRING DIAGRAM

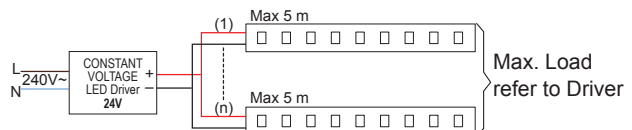

Model No.	Input	Power	Lumen	Colour Temp	Beam Angle	CRI (Ra)	Cuttable Length	Dimensions W x H	LED Quantity	Max. Length per run
FL2406WW/SS10	24V DC	6W/m	500lm/m	3000K	115°	>80	100 mm	10 mm x 1.6 mm	60/m	5 m
FL2406CW/SS10	24V DC	6W/m	500lm/m	4000K	115°	>80	100 mm	10 mm x 1.6 mm	60/m	5 m
FL2406DL/SS10	24V DC	6W/m	500lm/m	6000K	115°	>80	100 mm	10 mm x 1.6 mm	60/m	5 m
FL2412WW/SS10	24V DC	12W/m	980lm/m	3000K	115°	>80	100 mm	10 mm x 1.6 mm	60/m	5 m
FL2412CW/SS10	24V DC	12W/m	980lm/m	4000K	115°	>80	100 mm	10 mm x 1.6 mm	60/m	5 m
FL2412DL/SS10	24V DC	12W/m	980lm/m	6000K	115°	>80	100 mm	10 mm x 1.6 mm	60/m	5 m

### QUICK CONNECT KIT

Model No.	Description
FLC10CS	Twin 400 mm fly lead to connect 10 mm strip (pack of 10)
FLC10SS	Connector to join 10 mm strip (pack of 5)



# 24V LOW VOLTAGE HIGH OUTPUT LED STRIP IP20 FLH2420



## DIMENSIONS

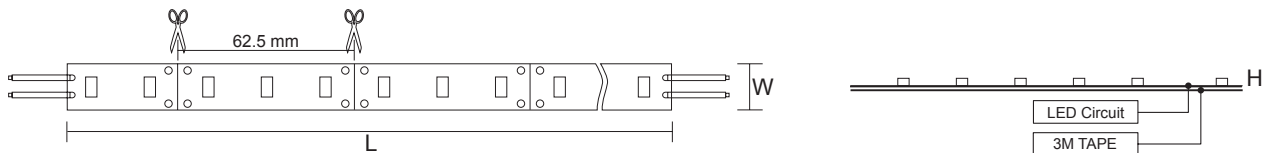

## CONSTRUCTION

- 24V IP20 LED flexible strip with self-adhesive 3M tape on the back
- High efficiency SMD LED chips
- High colour rendering with high output greater than 1500lm/m
- Max. roll length 5 m, cuttable every 62.5 mm at the scissors symbol ✂
- Connection length can be extended by certain LED drivers, controllers and repeaters
- Dimmable with compatible controller or dimmable constant voltage LED driver
- Heat sink and 24V constant voltage LED driver required

## IP RATING

- IP20 suitable for interior use only

## SUITABLE LED DRIVER

- Refer to Constant Voltage LED Driver & Dimmable Constant Voltage LED Driver section in the catalogue

## LED CHANNEL/ HEATSINK

**LED Channel options:** SLT1000, SLT3000, SLT3010, SLT3020, SLT3030, SLT3040, SLT3050, SLT4050, SLT5000

## DIMMING OPTIONS

### TYPE A

- Trailing edge dimming

### TYPE B

- LED Controller: LT8903DIM , LT8905DIM and LT8904DIM/RP

### TYPE C

- 1-10V analogue

## WIRING DIAGRAM

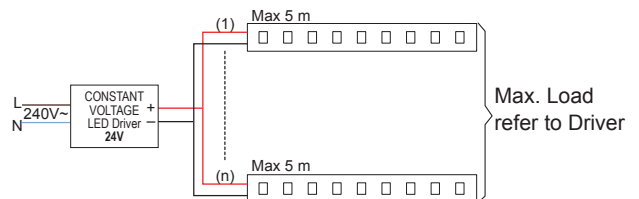

Model No.	Input	Power	Lumen	Colour Temp	Beam Angle	CRI (Ra)	Cuttable Length	Dimensions W x H	IP Rating	LED Quantity
FLH2420 WW	24V DC	20W/m	1700lm/m	3000K	115°	>80	62.5 mm	8 x 2 mm	IP20	96/m
FLH2420 CW	24V DC	20W/m	1800lm/m	4000K	115°	>80	62.5 mm	8 x 2 mm	IP20	96/m
FLH2420 DL	24V DC	20W/m	2000lm/m	6000K	115°	>80	62.5 mm	8 x 2 mm	IP20	96/m

# 24V LOW VOLTAGE RGB LED STRIP IP44

## FL2415RGB/S



### DIMENSIONS

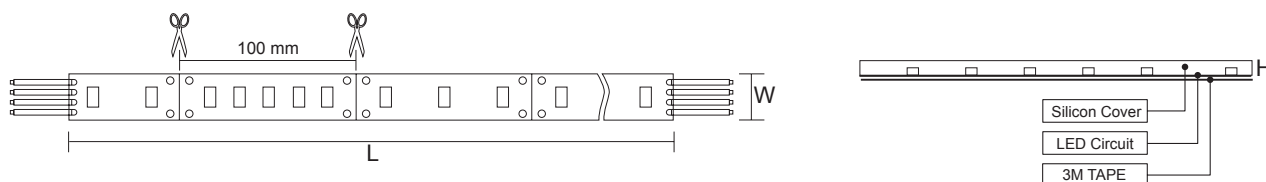

### CONSTRUCTION

- High efficiency SMD LED chips with 3M self-adhesive tapes at back
- Silicon covered
- Stable working performance and even light output
- Max. roll length 6 m, cuttable every 100 mm at the scissors symbol ✂
- Connection length can be extended by certain LED drivers, controllers and repeaters
- Heat sink and 24V constant voltage LED driver and controller required
- RGB colour changeable with compatible controller

### SUITABLE LED DRIVER

- Refer to Constant Voltage LED Driver section in the catalogue

### SUITABLE RGB LED CONTROLLER

- LT8903RGB, LT8905 RGB, LT8904 RGB/RP

### LED CHANNEL/HEATSINK

**LED Channel options:** SLT1000, SLT3000, SLT3010, SLT3020, SLT3030, SLT3040, SLT3050, SLT4050, SLT5000

### IP RATING

- IP44 weatherproof

Model No.	Input	Power	Beam Angle	Cutttable Length	Dimensions W x H	IP Rating	LED Quantity
FL2415RGB/S	24V DC	15W/m	115°	100 mm	10 x 3.5 mm	IP44	60/m

# QUICK CONNECT KIT

## FLC05CS, FLC10CS, FLC10SS

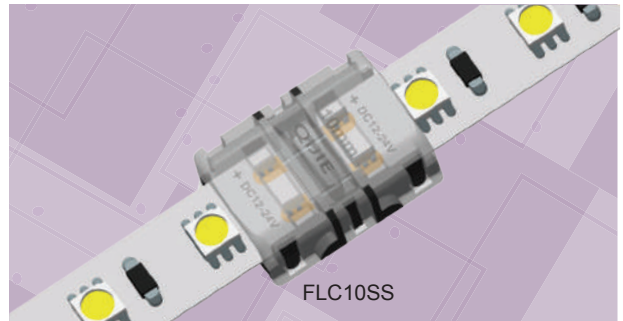
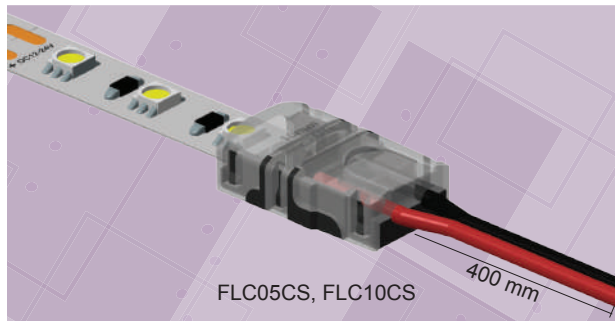

### DIMENSIONS

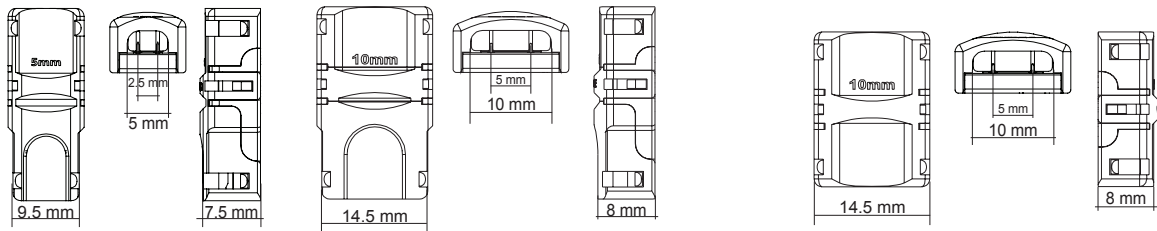

Model No.	Description	Usage
<b>FLC05CS</b>	Twin 400mm fly lead to connect 5 mm strip (pack of 10)	Suits FL2406R05
<b>FLC10CS</b>	Twin 400 mm fly lead to connect 10 mm strip (pack of 10)	Suits FL1206, FL1209/S, FL2406/SS10, FL2412/SS10
<b>FLC10SS</b>	Connector to join 10 mm strip (pack of 5)	Suits FL1206, FL1209/S, FL2406/SS10, FL2412/SS10

## FLC 400 S, FLC 400 RGB

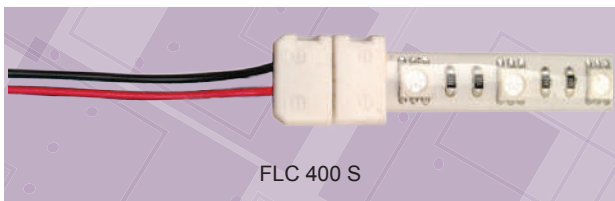

Model No.	Description	Usage
<b>FLC 400 S</b>	Led strip quick connect kit	Suits FL1206/S, FL2406/SS10, FL2412/SS10
<b>FLC 400 RGB</b>	Led strip quick connect kit RGB	Suits FL2415RGB/S, FLP12V5M/RGB, FLP12V2M/RGBBT, FLP12V5M/RGBBT,



## LED STRIP CHANNEL RANGE

Model No	Description	Length	Maximum Strip Width	Style
<b>SLT1000</b>	SURFACE MOUNTED CHANNEL	1 m	10 mm	surface
<b>SLT1000/2M</b>	SURFACE MOUNTED CHANNEL	2 m	10 mm	surface
<b>SLT3000</b>	SQUARE CHANNEL	1 m	10 mm	surface
<b>SLT3000/2M</b>	SQUARE CHANNEL	2 m	10 mm	surface
<b>SLT3010</b>	CLIP-ON CHANNEL TYPE 1	1 m	10 mm	clip-on
<b>SLT3010/2M</b>	CLIP-ON CHANNEL TYPE 1	2 m	10 mm	clip-on
<b>SLT3020</b>	CLIP-ON CHANNEL TYPE 2	1 m	10 mm	clip-on
<b>SLT3020/2M</b>	CLIP-ON CHANNEL TYPE 2	2 m	10 mm	clip-on
<b>SLT3030</b>	CLIP-ON CHANNEL TYPE 3	1 m	10 mm	clip-on
<b>SLT3030/2M</b>	CLIP-ON CHANNEL TYPE 3	2 m	10 mm	clip-on
<b>SLT3040</b>	RECESSED CABINET CHANNEL	1.2 m	10 mm	recessed
<b>SLT3050</b>	SURFACE MOUNTED CABINET CHANNEL	1 m	10 mm	surface
<b>SLT3050/2M</b>	SURFACE MOUNTED CABINET CHANNEL	2 m	10 mm	surface
<b>SLT4050</b>	RECESSED UNIVERSAL CHANNEL	1 m	10 mm	recessed
<b>SLT4050/2M</b>	RECESSED UNIVERSAL CHANNEL	2 m	10 mm	recessed
<b>SLT5000</b>	CORNER CHANNEL	1 m	10 mm	surface
<b>SLT5000/2M</b>	CORNER CHANNEL	2 m	10 mm	surface
<b>SLT6000</b>	NARROW RECESSED CHANNEL	1 m	5 mm	recessed
<b>SLT6000/2M</b>	NARROW RECESSED CHANNEL	2 m	5 mm	recessed
<b>SLT6010</b>	HANGING RAIL CHANNEL	1.2 m	5 mm	end mounted
<b>SLT6050</b>	TRIMLESS CHANNEL	1 m	5 mm	recessed
<b>SLT6050/2M</b>	TRIMLESS CHANNEL	2 m	5 mm	recessed

# LED STRIP CHANNEL

## SLT1000

- Extruded aluminium body
- Anodize silver finish
- Clear reeded polycarbonate diffuser
- Come with PVC clips and end cap
- Standard channel length: 1 m or 2 m

### DIMENSIONS

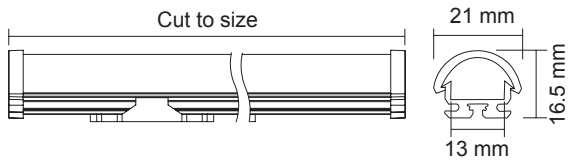

### SURFACE MOUNTED CHANNEL

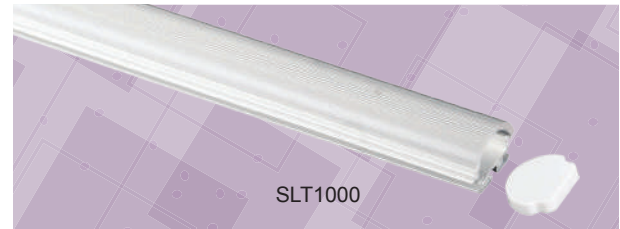

## SLT3000, SLT3010, SLT3020, SLT3030

- Extruded aluminium body
- Anodize silver finish
- Opal polycarbonate diffuser

- Comes with end cap (SLT3000)
- Standard channel length: 1 m or 2 m

### DIMENSIONS

SLT3000

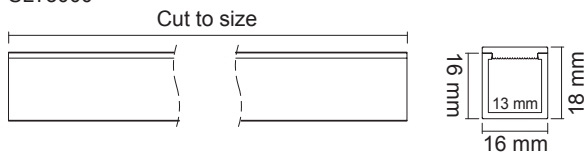

### SQUARE CHANNEL



SLT3010

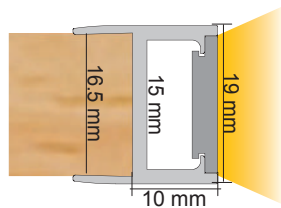

### CLIP-ON CHANNEL TYPE 1



SLT3020

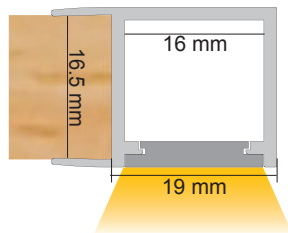

### CLIP-ON CHANNEL TYPE 2



SLT3030

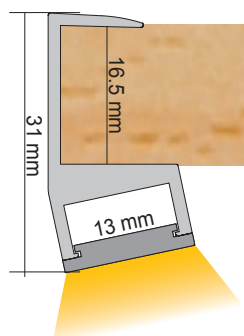

### CLIP-ON CHANNEL TYPE 3





## SLT3040, SLT3050

- Extruded aluminium body
- Anodize silver finish
- Opal polycarbonate diffuser
- Come with PVC clips and end cap (SLT3050)
- Standard channel length – SLT3050: 1 m or 2 m, SLT3040: 1.2 m

### DIMENSIONS

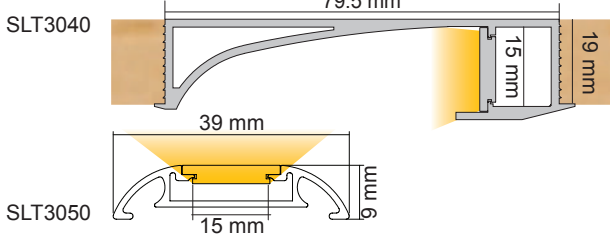

### RECESSED CABINET CHANNEL



### SURFACE MOUNTED CABINET CHANNEL



## SLT4050, SLT5000

- Extruded aluminium body
- Anodize silver finish
- Opal reeded polycarbonate diffuser
- Comes with end cap (SLT4050)
- Come with PVC clips and end cap (SLT5000)
- Standard channel length: 1 m or 2 m

### DIMENSIONS

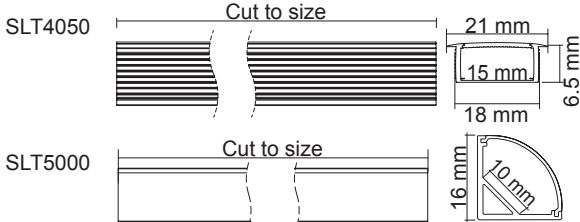

### RECESSED UNIVERSAL CHANNEL



### CORNER CHANNEL

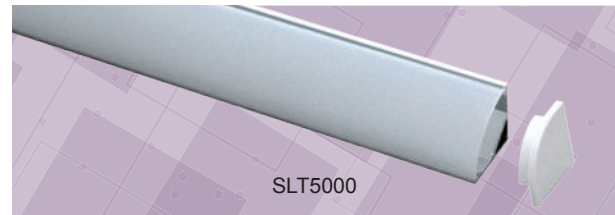

## SLT6000, SLT6010, SLT6050

- Extruded aluminium body
- Anodize silver finish
- Opal polycarbonate diffuser
- Standard channel length – SLT6000, SLT6050: 1 m or 2 m, SLT6010: 1.2 m

### DIMENSIONS

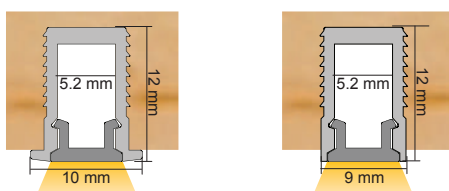
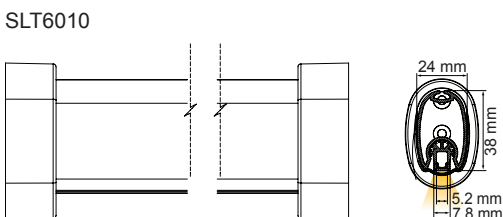

SLT6000

SLT6050

### NARROW RECESSED CHANNEL

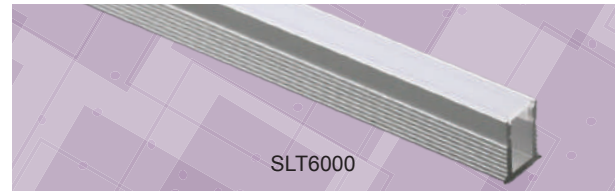

### HANGING RAIL CHANNEL



### TRIMLESS CHANNEL



# LOW VOLTAGE LED CONTROLLER

## LT8903 DIM

- Design for single colour LED brightness control
- Built-in 3 pre-set mode plus adjustable brightness & speed functions
- Adjustable 256 grey scale for fine and smooth change of brightness
- Each controller provides three output channels.
- Each channel has a maximum output current of 3A
- 216 W Max power output at 24V
- Equipped with IR remote controller

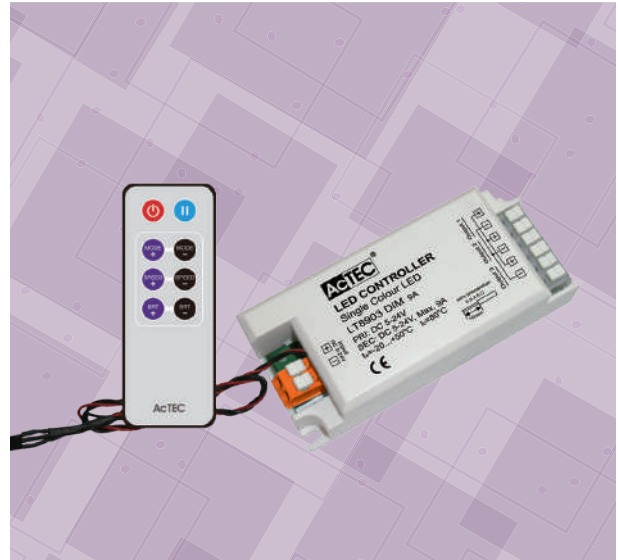

Model No.	Input / Output Voltage	Max Output Current	Max Output Power at 24V	Work Temperature	Dimensions L x W x H	Fixing Centre
LT8903 DIM	5 - 24V	3A x 3 channels	72W x 3 channels	-20° ~ +50°C	105 x 46 x 28 mm	97 mm

# RGB LED CONTROLLER

## LT8903 RGB

- Design for RGB LED colour brightness control
- Built-in 18 pre-set mode plus adjustable brightness & speed functions
- Adjustable 256 grey scale for fine and smooth change of brightness
- Static brightness and colour control: 16 steps for each RGB channel, i.e. 4096 different colours
- Three RGB independent control channels to create full colour control
- Each channel has a Max output current of 3A
- 216W Max power output at 24V
- Equipped with IR remote controller



Model No.	Input / Output Voltage	Max Output Current	Max Output Power at 24V	Work Temperature	Dimensions L x W x H
LT8903 RGB	6 - 24V	3A x 3 channels	72W x 3 channels	-20° ~ +50°C	105 x 46 x 28 mm

## LT8903 DIM MODE FUNCTIONS

No.	Style	Remarks
1	Static	Brightness adjustable
2	Single colour strobe	Brightness and speed adjustable
3	Single colour smooth	Brightness and speed adjustable

## DIMENSIONS

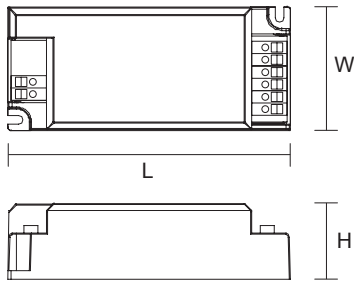

## OPTIONS

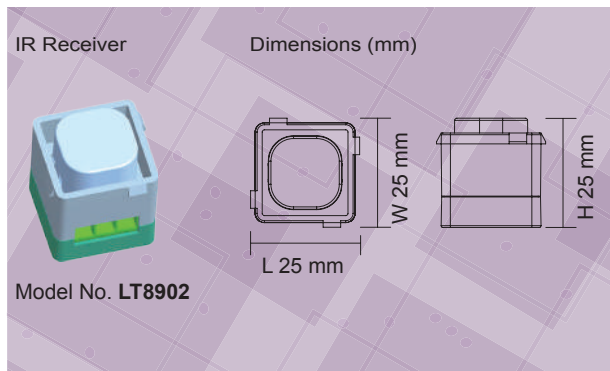

## LT8903 RGB MODE FUNCTIONS

No.	Style	Remarks
1	Static red	Brightness adjustable
2	Static green	Brightness adjustable
3	Static blue	Brightness adjustable
4	Static yellow	Brightness adjustable
5	Static purple	Brightness adjustable
6	Static cyan	Brightness adjustable
7	Static white	Brightness adjustable
8	3-colour skipping (RGB)	Brightness & speed adjustable
9	7-colour skipping	Brightness & speed adjustable
10	White colour strobe	Brightness & speed adjustable
11	3-colour smooth (RGB)	Brightness & speed adjustable
12	Full colour smooth	Brightness & speed adjustable
13	RG colour smooth	Brightness & speed adjustable
14	RB colour smooth	Brightness & speed adjustable
15	GB colour smooth	Brightness & speed adjustable
16	White colour fade & change	Brightness & speed adjustable
17	Great cycle	MODE 8-16
18	RGB static dimming	16 levels of brightness per RGB

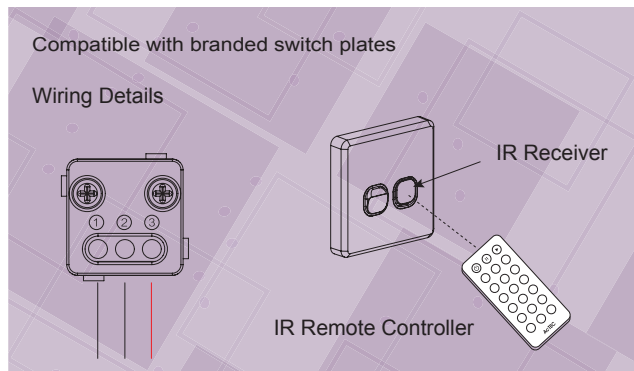

## WIRING DIAGRAM

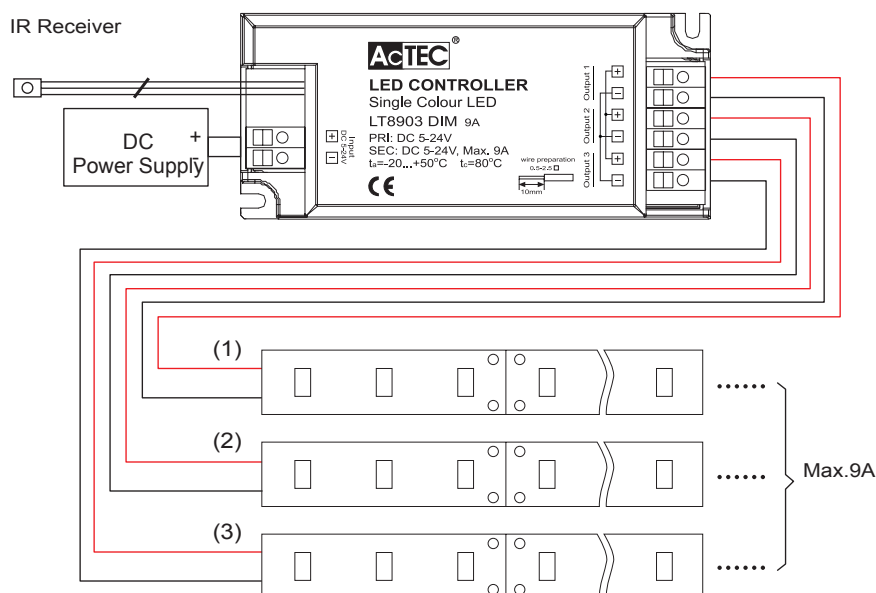

# LOW VOLTAGE LED REPEATER

## LT8904 DIM/RP

- Design for extending single colour LED strip lights
- With the repeater, one single colour controller controls multiple connections of LED strips
- Each repeater provides two channel output
- Each channel has a Max output current of 4.5A
- 216W Max power output at 24V



Model No.	Input / Output Voltage	Max Output Current	Max Output Power at 24V	Work Temperature	Dimensions L x W x H	Fixing Centre
LT8904 DIM/RP	5 - 24V	4.5A x 2 channels	108W x 2 channels	-20° ~ +50°C	105 x 46 x 28 mm	97 mm

# RGB LED REPEATER

## LT8904 RGB/RP

- Design for extending RGB LED strip lights
- With repeater, one RGB controller can control multiple connections of LED strips
- Each repeater provides three RGB channels output
- Each channel has a maximum output current of 3A
- 216W Max power output at 24V



Model No.	Input / Output Voltage	Max Output Current	Max Output Power at 24V	Work Temperature	Dimensions L x W x H	Fixing Centre
LT8904 RGB/RP	5 - 24V	3A x 3 channels	72W x 3 channels	-20° ~ +50°C	105 x 46 x 28 mm	97 mm

# WIRING DIAGRAM

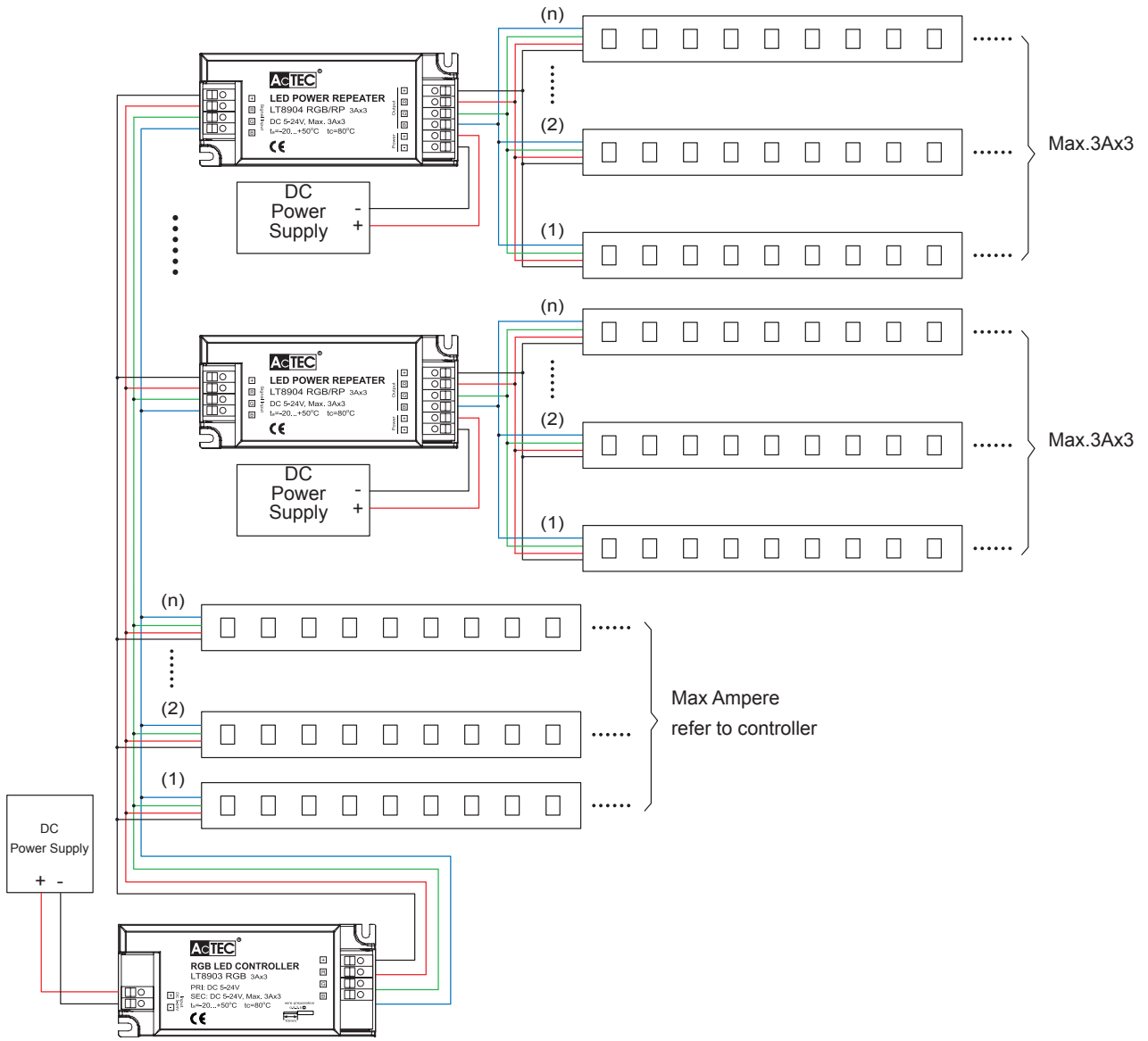

# DIMENSIONS

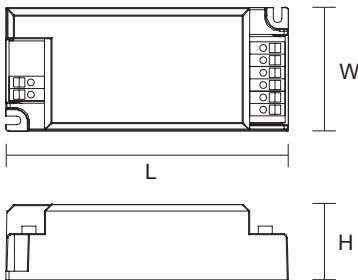

LT8904

# LOW VOLTAGE LED CONTROLLER

## LT8905 DIM

- Design for single colour LED brightness control
- Built-in 3 pre-set mode plus adjustable brightness & speed functions
- Each controller provides 2 output channels
- Each channel has a Max output current of 9A
- 432W Max power output at 24V
- Equipped with key panel IR remote controller
- Key panel is compatible with branded 6 gangs with plate



Model No.	Input / Output Voltage	Max Output Current	Max Output Power at 24V	Work Temperature	Dimensions Controller L x W x H	Dimensions Key Board L x W x H
LT8905 DIM	5 - 24V	9A x 2 channels	216W x 2 channels	-20° ~ +50°C	145 x 80 x 30 mm	72 x 46 x 38 mm

# RGB LED CONTROLLER

## LT8905 RGB

- Design for RGB LED colour brightness control
- Built-in 18 pre-set mode plus adjustable brightness & speed functions
- Adjustable 256 grey scale for fine and smooth change of colours
- Static control of colour and brightness: 16 steps for each RGB channel, i.e. 4096 different colours
- Three RGB independent control channels to create full colour control.
- Each channel has a maximum output current of 6A
- 432W Max power output at 24V
- Equipped with key panel IR remote controller



Model No.	Input / Output Voltage	Max Output Current	Max Output Power at 24V	Work Temperature	Dimensions Controller L x W x H	Dimensions Key Board L x W x H
LT8905 RGB	5 - 24V	6A x 3 channels	144W x 3 channels	-20° ~ +50°C	146 x 80 x 30 mm	72 x 46 x 38 mm



## LT8905 DIM

No.	Style	Remarks
1	Static	Brightness adjustable
2	Single colour strobe	Brightness and speed adjustable
3	Single colour smooth	Brightness and speed adjustable

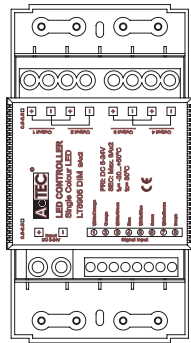

LT8905 DIM/RGB Controller

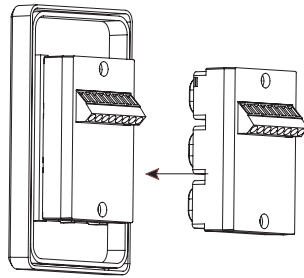

LT8905 DIM/RGB Key Panel Back

## LT8905 RGB

No.	Style	Remarks
1	Static red	Brightness adjustable
2	Static green	Brightness adjustable
3	Static blue	Brightness adjustable
4	Static yellow	Brightness adjustable
5	Static purple	Brightness adjustable
6	Static cyan	Brightness adjustable
7	Static white	Brightness adjustable
8	3-colour skipping (RGB)	Brightness & speed adjustable
9	7-colour skipping	Brightness & speed adjustable
10	White colour strobe	Brightness & speed adjustable
11	3-colour smooth (RGB)	Brightness & speed adjustable
12	Full colour smooth	Brightness & speed adjustable
13	RG colour smooth	Brightness & speed adjustable
14	RB colour smooth	Brightness & speed adjustable
15	GB colour smooth	Brightness & speed adjustable
16	White colour fade & change	Brightness & speed adjustable
17	Great cycle	MODE 8-16
18	RGB static dimming	16 levels of brightness per RGB

RJ45 Pin Number	CAT.5 Wire Colour
1	White/Orange
2	Orange
3	White/Green
4	Blue
5	White/Blue
6	Green
7	White/Brown
8	Brown

## WIRING DIAGRAM

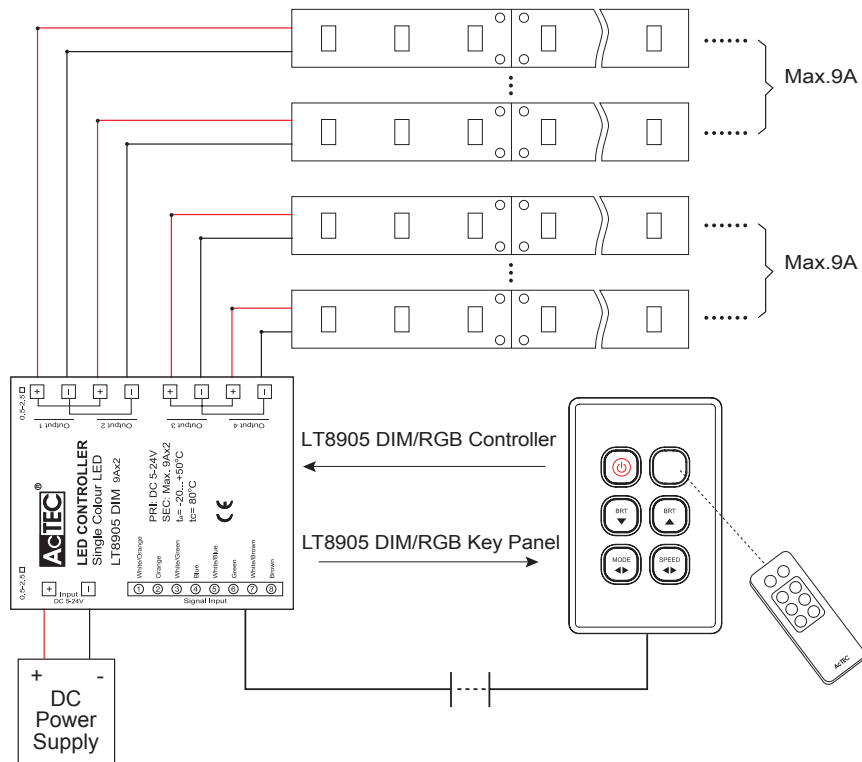



[www.sal.net.au](http://www.sal.net.au)

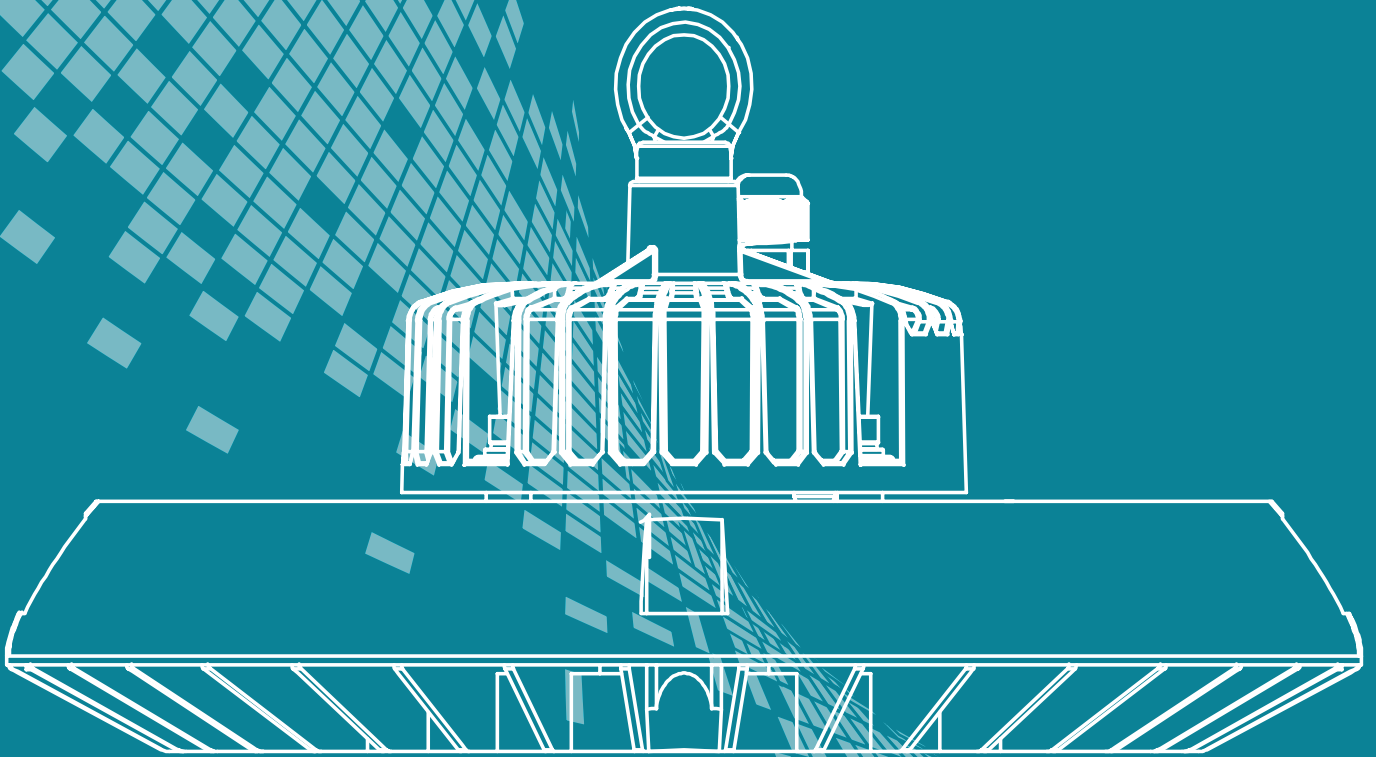

# LED EXTERIOR LIGHTS

## NEW PRODUCTS



# LED FLOOD LIGHT

## SPK1000, SPK2000 STARLIGHT



### DIMENSIONS

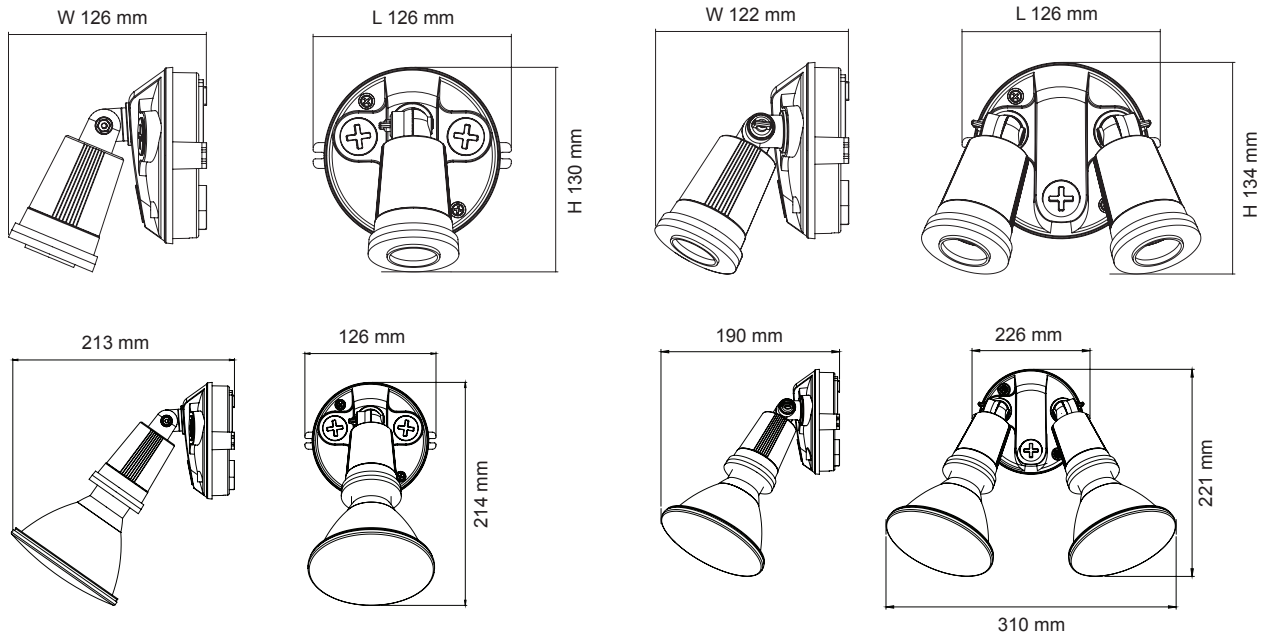

### CONSTRUCTION

- Independently adjustable heads
- UV stabilized plastic body
- E27 lamp base
- PAR38 LED lamp included

### IP RATING

- IP54 weatherproof

Model No.	Input	Power	Lumen	CCT	Beam Angle	CRI	Fitting Colour
SPK1000 DL BK	240V	12W	1050lm	6000K	100°	>80	Black
SPK2000 DL BK	240V	2 x 12W	2 x 1050lm	6000K	100°	>80	Black

# LED FLOOD LIGHT

## SPSK1000, SPSK2000 STARLIGHT WITH SENSOR



### DIMENSIONS

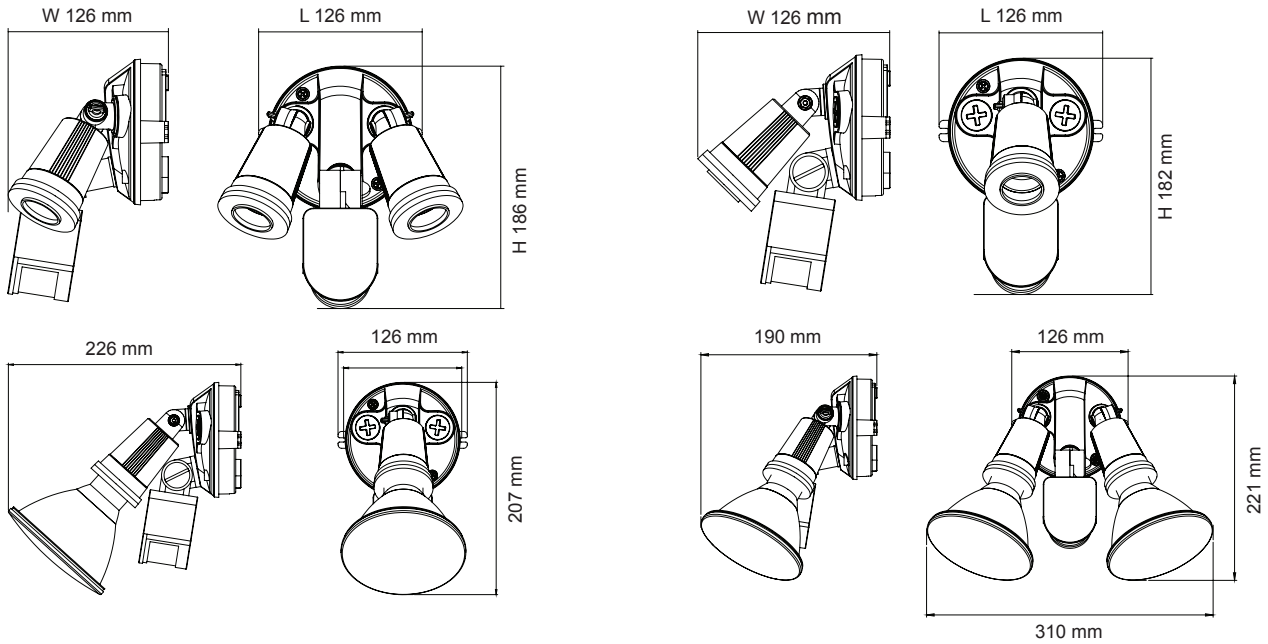

### CONSTRUCTION

- Independently adjustable heads
- UV stabilized plastic body
- E27 lamp base
- PAR38 LED lamp included
- Built-in infrared motion sensor with override function
- Installation height: 1.5-3.5 m

### IP RATING

- IP54 weatherproof

Model No.	Input	Power	Lumen	CCT	Beam Angle	CRI	Fitting Colour
SPSK1000 DL BK	240V	12W	1050lm	6000K	100°	>80	Black
SPSK2000 DL BK	240V	2 x 12W	2 x 1050lm	6000K	100°	>80	Black

### SENSOR SPECIFICATIONS

Power Source	Detection Range	Detection Angle	Working Temperature	Time Setting	Lux Threshold	Power	Detection Motion Speed
240V	12 m @ 2.5 m height	180°	-10°C~+40°C	10sec-4min	10-2000lux	0.45W (Static 0.1W)	0.6-1.5 m/s



# LED FLOOD LIGHT

## SE7080/1, SE7080/2 STARGEM



### DIMENSIONS

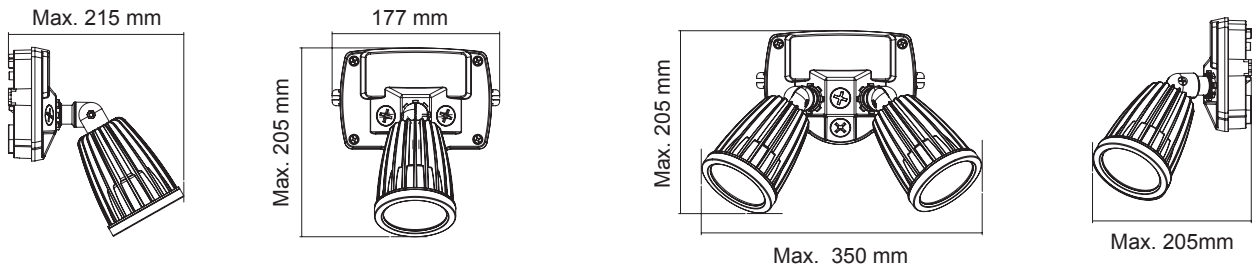

### CONSTRUCTION

- Independently adjustable heads
- Polycarbonate construction base
- Die-cast aluminium heat sink
- Powder coated finish
- Opal polycarbonate lens
- Clear tempered glass cover

- High efficiency SMD LED chips
- High efficiency aluminium reflector
- Built-in constant current non-dimmable LED driver

### IP RATING

- IP54 weatherproof

Model No.	Input	Power	Lumen	CCT	CRI	Fitting Colour
SE7080/1 WW BK	240V	15W	1100lm	3000K	>80	Black
SE7080/1 DL BK	240V	15W	1200lm	6000K	>80	Black

Model No.	Input	Power	Lumen	CCT	CRI	Fitting Colour
SE7080/2 WW SL	240V	2 x 15W	2 x 1100lm	3000K	>80	Silver
SE7080/2 WW BK	240V	2 x 15W	2 x 1100lm	3000K	>80	Black
SE7080/2 DL SL	240V	2 x 15W	2 x 1200lm	6000K	>80	Silver
SE7080/2 DL BK	240V	2 x 15W	2 x 1200lm	6000K	>80	Black



# LED FLOOD LIGHT

## SES7080/1, SES7080/2 STARGEM WITH SENSOR

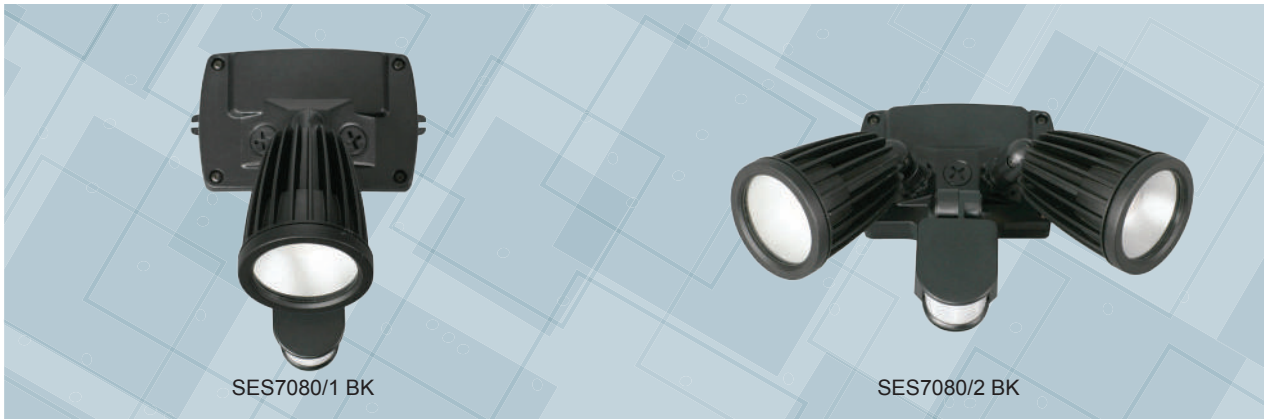

SES7080/1 BK

SES7080/2 BK

### DIMENSIONS

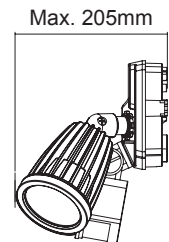
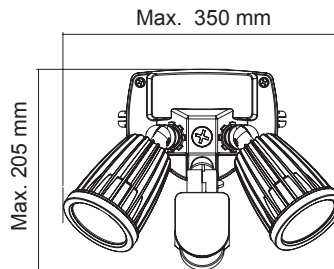
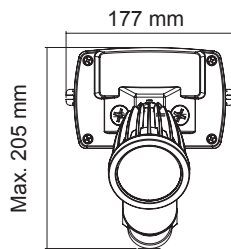
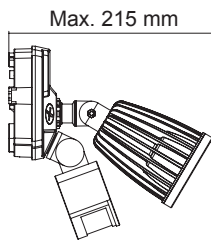

### CONSTRUCTION

- Independently adjustable heads
- Polycarbonate construction base
- Die-cast aluminium heat sink
- Powder coated finish
- Opal polycarbonate lens
- Clear tempered glass cover

- High efficiency SMD LED chips
- High efficiency aluminium reflector
- Built-in constant current non-dimmable LED driver
- Built-in infrared motion sensor with override function
- Installation height: 1.5-3.5 m

### IP RATING

- IP54 weatherproof

Model No.	Input	Power	Lumen	CCT	CRI	Fitting Colour
SES7080/1 WW BK	240V	15W	1100lm	3000K	>80	Black
SES7080/1 DL BK	240V	15W	1200lm	6000K	>80	Black

Model No.	Input	Power	Lumen	CCT	CRI	Fitting Colour
SES7080/2 WW BK	240V	2 x 15W	2 x 1100lm	3000K	>80	Black
SES7080/2 DL BK	240V	2 x 15W	2 x 1200lm	6000K	>80	Black

### SENSOR SPECIFICATIONS

Power Source	Detection Range	Detection Angle	Working Temperature	Time Setting	Lux Threshold	Power	Detection Motion Speed
240V	12 m @ 2.5 m height	180°	-10°C~+40°C	10sec-4min	10-2000lux	0.45W (Static 0.1W)	0.6-1.5 m/s



# LED FLOOD LIGHT

## SE7060, SES7060 STARGEM II



### DIMENSIONS

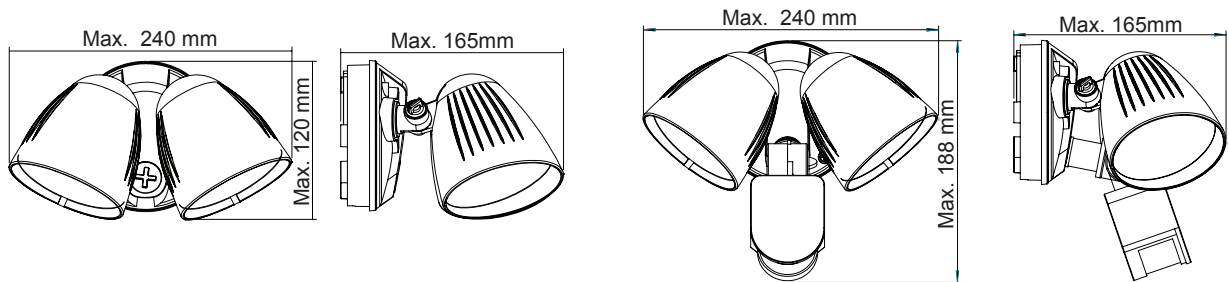

### CONSTRUCTION

- Independently adjustable heads
- Polycarbonate body and base
- Opal polycarbonate diffuser
- High efficiency SMD LED chips
- Built-in constant current non-dimmable LED driver

- Built-in infrared motion sensor with override function (SES7060 only)
- Installation height: 1.5-3.5 m

### IP RATING

- IP54 weatherproof

Model No.	Input	Power	Lumen	CCT	Beam Angle	CRI	Fitting Colour	Sensor
SE7060NDL/BK	240V	2x10W	2x800lm	5000K	100°	>80	Black	No
SES7060NDL/BK	240V	2x10W	2x800lm	5000K	100°	>80	Black	Yes

### SENSOR SPECIFICATIONS

Power Source	Detection Range	Detection Angle	Working Temperature	Time Setting	Lux Threshold	Power	Detection Motion Speed
240V	12 m @ 2.5 m height	180°	-10°C~+40°C	10sec-4min	10-2000lux	0.45W (Static 0.1W)	0.6-1.5 m/s

# LED FLOOD LIGHT

## SES7090/2 BATWING



### DIMENSIONS

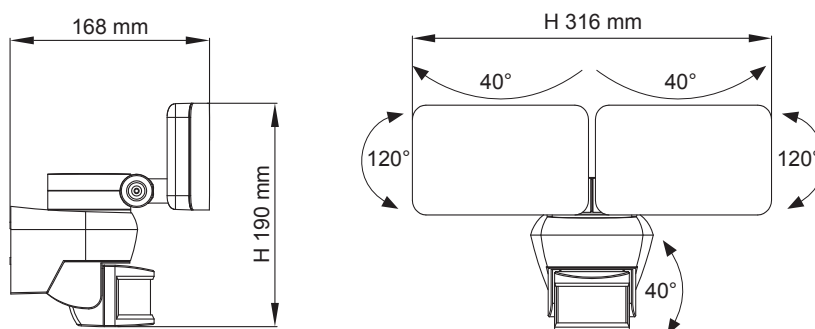

### CONSTRUCTION

- Independently adjustable heads
- Polycarbonate mounting base
- Die-cast aluminium heat sink
- Powder coated finish
- UV stabilised opal polycarbonate diffuser
- High efficiency SMD LED chips

- Built-in constant current non-dimmable LED driver
- Built-in infrared motion sensor with override function
- Installation height: 1.5-3.5 m

### IP RATING

- IP54 weatherproof

Model No.	Input	Power	Lumen	CCT	CRI	Fitting Colour
SES7090/2WW/BK	240V	2 x 20W	2 x 1600lm	3000K	>80	Black
SES7090/2DL/BK	240V	2 x 20W	2 x 1750lm	6000K	>80	Black

### SENSOR SPECIFICATIONS

Power Source	Detection Range	Detection Angle	Working Temperature	Time Setting	Lux Threshold	Power	Detection Motion Speed
240V	18 m @ 2.5 m height	180°	-20°C~+40°C	10sec-8min	5-2000lux	0.45W (Static 0.1W)	0.6-1.5 m/s

# LED FLOOD LIGHT

## SE7071 STARPAD

**IP65**



### DIMENSIONS

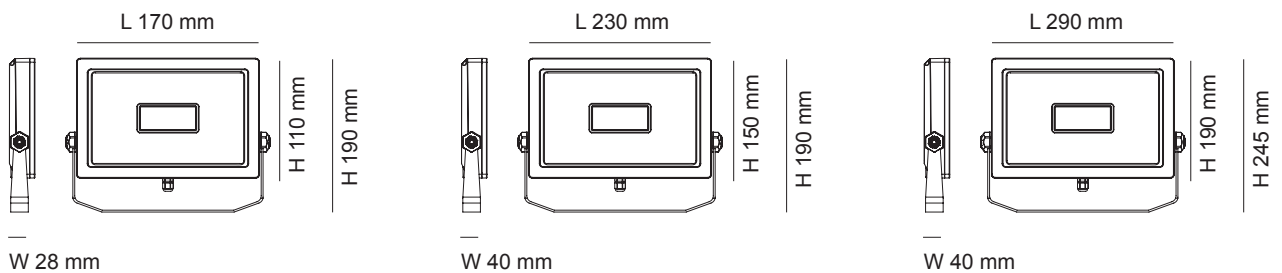

### CONSTRUCTION

- Die-cast aluminium body
- Powder coated finish
- Clear tempered glass front cover
- High efficiency SMD LED chips
- Frost polycarbonate diffuser
- High performance aluminium reflector
- Built-in constant current non-dimmable LED driver
- IP67 nickel plated copper cable gland
- 600 mm 3 core rubber flex

### IP RATING

- IP65 weatherproof

### FITTING COLOUR

- Black
- White
- Silver

### COLOUR TEMPERATURE

- 3000K Warm White
- 5000K Neutral Daylight

Model No.	Input	Power	Lumen	CCT	Beam Angle	CRI	Fitting Colour
SE7071/15WW/WH	240V	15W	1100lm	3000K	110°	>80	White
SE7071/15WW/SL	240V	15W	1100lm	3000K	110°	>80	Silver
SE7071/15WW/BK	240V	15W	1100lm	3000K	110°	>80	Black
SE7071/15DL/WH	240V	15W	1200lm	5000K	110°	>80	White
SE7071/15DL/SL	240V	15W	1200lm	5000K	110°	>80	Silver
SE7071/15DL/BK	240V	15W	1200lm	5000K	110°	>80	Black

Model No.	Input	Power	Lumen	CCT	Beam Angle	CRI	Fitting Colour
SE7071/30WW/WH	240V	30W	2300lm	3000K	110°	>80	White
SE7071/30WW/SL	240V	30W	2300lm	3000K	110°	>80	Silver
SE7071/30WW/BK	240V	30W	2300lm	3000K	110°	>80	Black
SE7071/30DL/WH	240V	30W	2500lm	5000K	110°	>80	White
SE7071/30DL/SL	240V	30W	2500lm	5000K	110°	>80	Silver
SE7071/30DL/BK	240V	30W	2500lm	5000K	110°	>80	Black

Model No.	Input	Power	Lumen	CCT	Beam Angle	CRI	Fitting Colour
SE7071/50WW/WH	240V	50W	3700lm	3000K	110°	>80	White
SE7071/50WW/SL	240V	50W	3700lm	3000K	110°	>80	Silver
SE7071/50WW/BK	240V	50W	3700lm	3000K	110°	>80	Black
SE7071/50DL/WH	240V	50W	3900lm	5000K	110°	>80	White
SE7071/50DL/SL	240V	50W	3900lm	5000K	110°	>80	Silver
SE7071/50DL/BK	240V	50W	3900lm	5000K	110°	>80	Black

**PHOTOMETRIC DATA** Unit: cd C0/C180 \_\_\_\_\_ C90/C270 \_\_\_\_\_

SE7071/30DL/BK

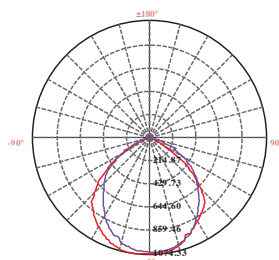

SE7071/50DL/BK

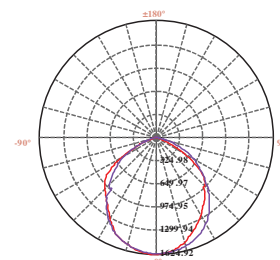

# LED FLOOD LIGHT

## SE7174 NEW STAR

**IP65**



SE7174/10 BK

SE7174/20 BK

SE7174/30 BK

### DIMENSIONS

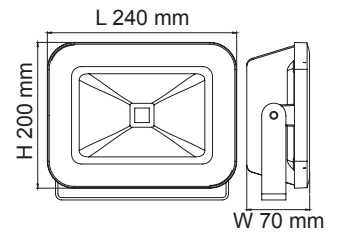
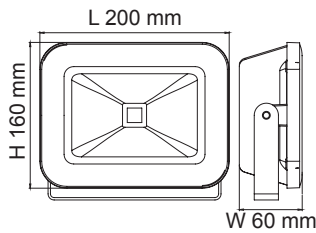
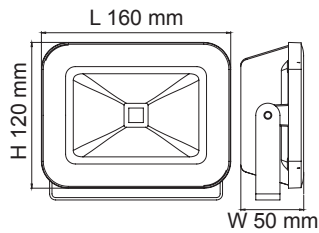

### CONSTRUCTION

- Die-cast aluminium body
- Powder coated finish
- Clear tempered glass front cover
- High output COB LED chip
- High performance aluminium reflector

- Built-in constant current non-dimmable LED driver
- IP67 nickel plated copper cable gland
- 600 mm 3 core rubber flex

### IP RATING

- IP65 weatherproof

Model No.	Input	Power	Lumen	CCT	Beam Angle	CRI	Fitting Colour
SE7174/10WW/SL	240V	10W	700lm	3000K	120°	>80	Silver
SE7174/10WW/BK	240V	10W	700lm	3000K	120°	>80	Black
SE7174/10DL/SL	240V	10W	800lm	5700K	120°	>80	Silver
SE7174/10DL/BK	240V	10W	800lm	5700K	120°	>80	Black
SE7174/20WW/SL	240V	20W	1500lm	3000K	120°	>80	Silver
SE7174/20WW/BK	240V	20W	1500lm	3000K	120°	>80	Black
SE7174/20DL/SL	240V	20W	1700lm	5700K	120°	>80	Silver
SE7174/20DL/BK	240V	20W	1700lm	5700K	120°	>80	Black
SE7174/30WW/SL	240V	30W	2300lm	3000K	120°	>80	Silver
SE7174/30WW/BK	240V	30W	2300lm	3000K	120°	>80	Black
SE7174/30DL/SL	240V	30W	2500lm	5700K	120°	>80	Silver
SE7174/30DL/BK	240V	30W	2500lm	5700K	120°	>80	Black

### PHOTOMETRIC DATA Unit: cd C0/C180 — C90/C270

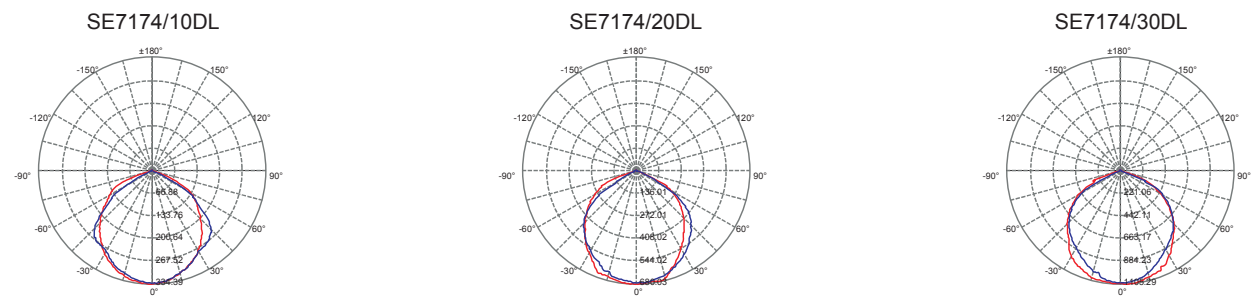





SE7174/50 BK

SE7174/100 BK

### DIMENSIONS

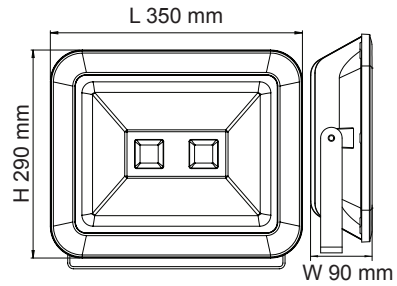
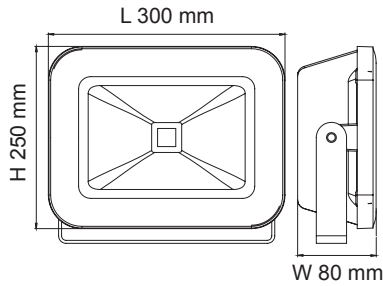

Model No.	Input	Power	Lumen	CCT	Beam Angle	CRI	Fitting Colour
SE7174/50WW/SL	240V	50W	3900lm	3000K	120°	>80	Silver
SE7174/50WW/BK	240V	50W	3900lm	3000K	120°	>80	Black
SE7174/50DL/SL	240V	50W	4200lm	5700K	120°	>80	Silver
SE7174/50DL/BK	240V	50W	4200lm	5700K	120°	>80	Black
SE7174/100WW/SL	240V	100W	8000lm	3000K	120°	>80	Silver
SE7174/100WW/BK	240V	100W	8000lm	3000K	120°	>80	Black
SE7174/100DL/SL	240V	100W	8000lm	5700K	120°	>80	Silver
SE7174/100DL/BK	240V	100W	8000lm	5700K	120°	>80	Black

### PHOTOMETRIC DATA Unit: cd C0/C180 — C90/C270

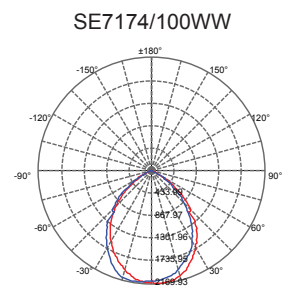
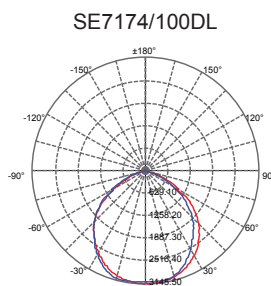
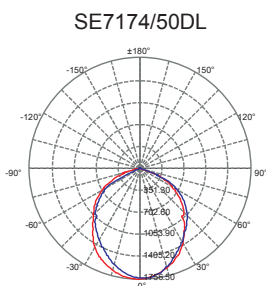

# LED COMMERCIAL FLOOD LIGHT

## SE7099 MAXISTAR



### DIMENSIONS

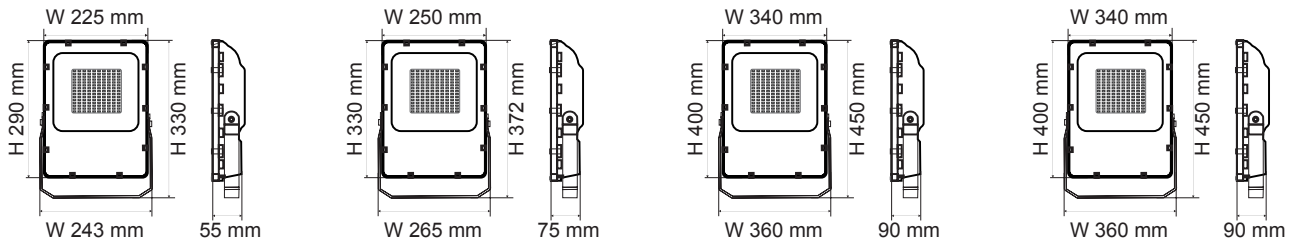

### CONSTRUCTION

- Premium grade aluminium body
- Powder coated finish
- Textured tempered glass cover
- High efficiency SMD LED chips
- Built-in constant current non-dimmable LED driver
- 1.5 m 3 core rubber flex

### IP RATING

- IP66 weatherproof

### FITTING COLOUR

- Black, Silver

### COLOUR TEMPERATURE

- 3000K Warm White
- 5700K Daylight

Model No.	Input	Power	Lumen	CCT	Beam Angle	CRI	Fitting Colour	Net Weight
SE7099/50WW/BK	240V	50W	4500lm	3000K	120°	>80	Black	3.1 kg
SE7099/50WW/SL	240V	50W	4500lm	3000K	120°	>80	Silver	3.1 kg
SE7099/50DL/BK	240V	50W	5000lm	5700K	120°	>80	Black	3.1 kg
SE7099/50DL/SL	240V	50W	5000lm	5700K	120°	>80	Silver	3.1 kg

Model No.	Input	Power	Lumen	CCT	Beam Angle	CRI	Fitting Colour	Net Weight
SE7099/75WW/BK	240V	75W	6500lm	3000K	120°	>80	Black	4.8 kg
SE7099/75WW/SL	240V	75W	6500lm	3000K	120°	>80	Silver	4.8 kg
SE7099/75DL/BK	240V	75W	7500lm	5700K	120°	>80	Black	4.8 kg
SE7099/75DL/SL	240V	75W	7500lm	5700K	120°	>80	Silver	4.8 kg



Model No.	Input	Power	Lumen	CCT	Beam Angle	CRI	Fitting Colour	Net Weight
SE7099/150WW/BK	240V	150W	13000lm	3000K	120°	>80	Black	8.1 kg
SE7099/150WW/SL	240V	150W	13000lm	3000K	120°	>80	Silver	8.1 kg
SE7099/150DL/BK	240V	150W	15000lm	5700K	120°	>80	Black	8.1 kg
SE7099/150DL/SL	240V	150W	15000lm	5700K	120°	>80	Silver	8.1 kg

Model No.	Input	Power	Lumen	CCT	Beam Angle	CRI	Fitting Colour	Net Weight
SE7099/200WW/BK	240V	200W	20000lm	3000K	120°	>80	Black	8.3 kg
SE7099/200WW/SL	240V	200W	20000lm	3000K	120°	>80	Silver	8.3 kg
SE7099/200DL/BK	240V	200W	22000lm	5700K	120°	>80	Black	8.3 kg
SE7099/200DL/SL	240V	200W	22000lm	5700K	120°	>80	Silver	8.3 kg

## ACCESSORIES

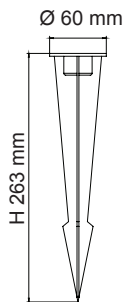

SE7099SPK/BK

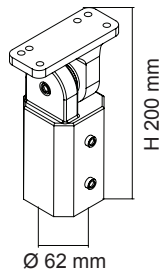

SE7099PMB/BK

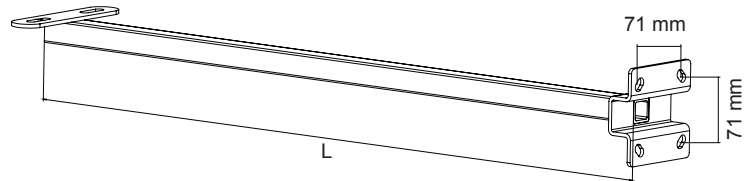

SE7099AMB/BK5, SE7099AMB/BK8, SE7099AMB/BK10

Model No.	Description	Dimensions
SE7099SPK/BK	Spike	Ø 60 mm x H 263 mm
SE7099PMB/BK	Pole mounting bracket (for SE7099/50 & SE7099/75 only)	Ø 62 mm x H 200 mm
SE7099AMB/BK5	Arm mounting bracket	L 500 mm
SE7099AMB/BK8	Arm mounting bracket	L 800 mm
SE7099AMB/BK10	Arm mounting bracket	L 1000 mm

## PHOTOMETRIC DATA Unit: cd C0/C180 — C90/C270 —

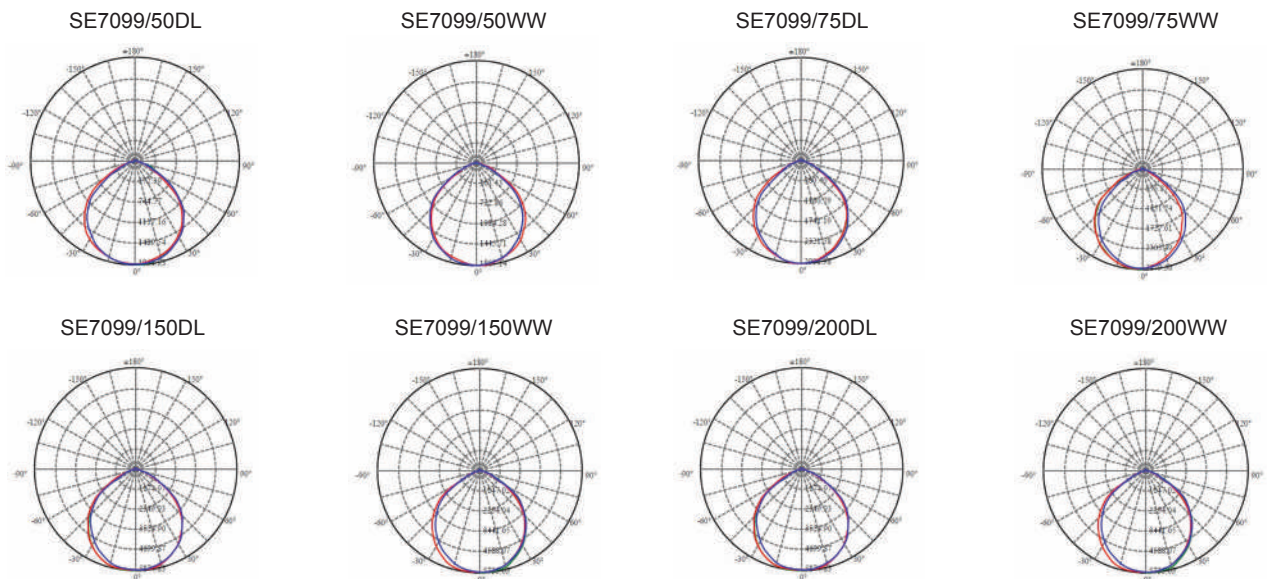

# LED COMMERCIAL FLOOD LIGHT

## SE7199 BRIGHT STAR



### DIMENSIONS

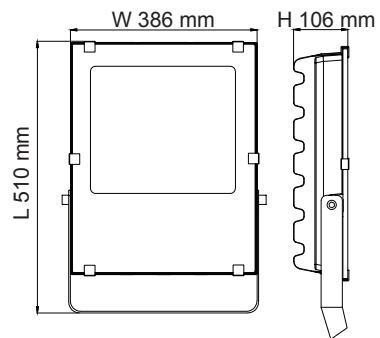
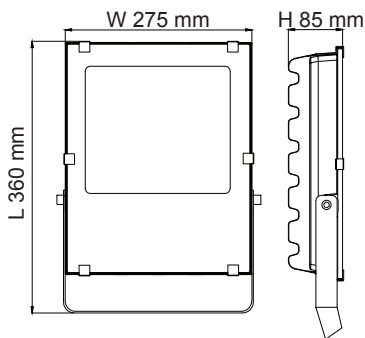

### CONSTRUCTION

- Premium grade aluminium body
- Powder coated finish
- Textured tempered glass cover
- High efficiency SMD LED chips
- Built-in constant current non-dimmable LED driver
- Angled bracket for easy installation
- 1.5 m 3 core rubber flex

### IP RATING

- IP65 weatherproof

### FITTING COLOUR

- Black

### COLOUR TEMPERATURE

- 3000K Warm White
- 5000K Neutral Daylight

Model No.	Input	Power	Lumen	CCT	Beam Angle	CRI	Net Weight
SE7199/100WW/BK	240V	100W	9500lm	3000K	100°	>80	3.9 kg
SE7199/100NDL/BK	240V	100W	9500lm	5000K	100°	>80	3.9 kg
SE7199/200WW/BK	240V	200W	19000lm	3000K	100°	>80	8.1 kg
SE7199/200NDL/BK	240V	200W	19000lm	5000K	100°	>80	8.1 kg
SE7199/250WW/BK	240V	250W	22800lm	3000K	100°	>80	8.2 kg
SE7199/250NDL/BK	240V	250W	22800lm	5000K	100°	>80	8.2 kg

## ACCESSORIES

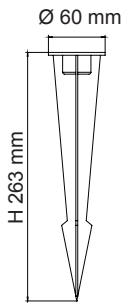

SE7099SPK/BK

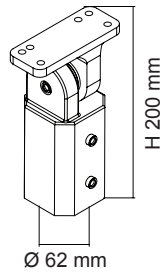

SE7099PMB/BK

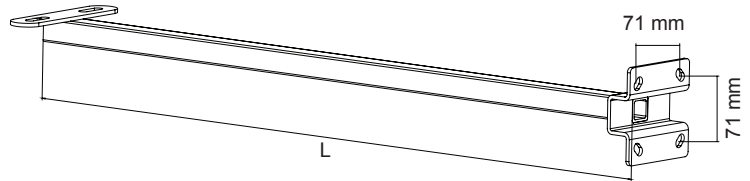

SE7099AMB/BK5, SE7099AMB/BK8, SE7099AMB/BK10

Model No.	Description	Dimensions
SE7099SPK/BK	Spike	Ø 60 mm x H 263 mm
SE7099PMB/BK	Pole mounting bracket (for SE7199/100 only)	Ø 62 mm x H 200 mm
SE7099AMB/BK5	Arm mounting bracket	L 500 mm
SE7099AMB/BK8	Arm mounting bracket	L 800 mm
SE7099AMB/BK10	Arm mounting bracket	L 1000 mm

## PHOTOMETRIC DATA

Unit: cd C0/C180 — C90/C270

SE7199/100NDL

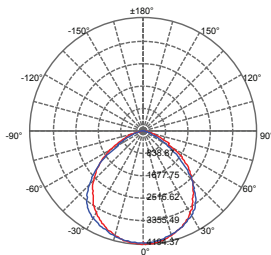

SE7199/200NDL

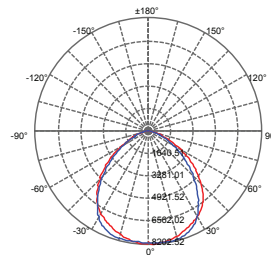

SE7199/250NDL

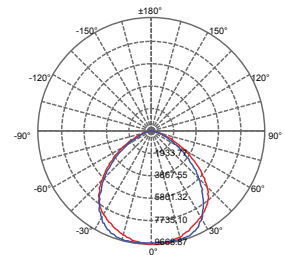

# LED SURFACE FITTING

## SE7250, SE7251, SE7252 M-SERIES



### DIMENSIONS

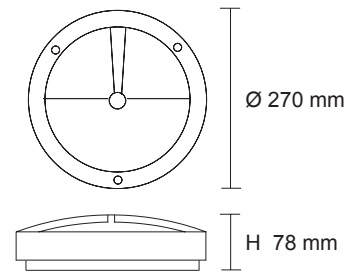
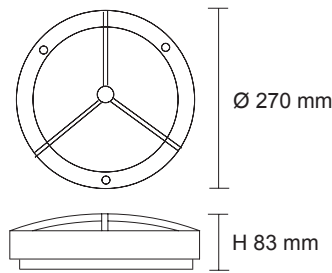
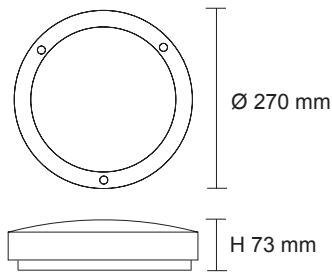

### CONSTRUCTION

- Die-cast aluminium body
- Powder coated finish
- Frosted glass diffuser
- E27 lamp base
- Lamp NOT included

### IP RATING

- IP54 weatherproof

### LAMP OPTIONS

- LT407, LFR35

Model No.	Input	Fitting Colour
SE7250 WH	240V	White
SE7250 SL	240V	Silver
SE7250 BK	240V	Black
SE7251 WH	240V	White
SE7251 SL	240V	Silver
SE7251 BK	240V	Black
SE7252 WH	240V	White
SE7252 SL	240V	Silver
SE7252 BK	240V	Black



# LED SURFACE FITTING

## SE7253, SE7254, SE7255 C-SERIES

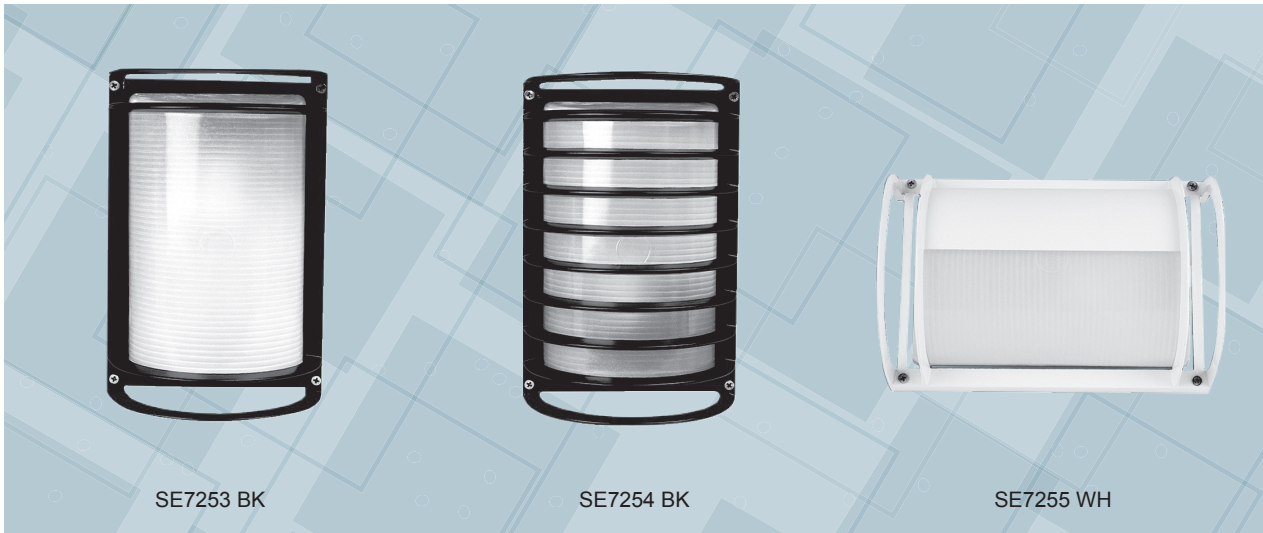

### DIMENSIONS

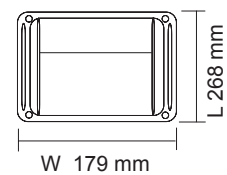
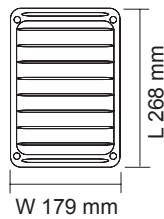
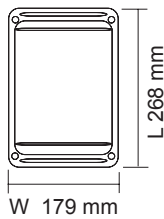

### CONSTRUCTION

- Die-cast aluminium body
- Powder coated finish
- Frosted glass diffuser
- E27 lamp base
- Lamp NOT included

### IP RATING

- IP54 weatherproof

### LAMP OPTIONS

- LG5, LG9
- LGS4, LGS8, LGS10, LGS14D
- LT407, LT409

Model No.	Input	Fitting Colour
SE7253 WH	240V	White
SE7253 SL	240V	Silver
SE7253 BK	240V	Black
SE7254 WH	240V	White
SE7254 SL	240V	Silver
SE7254 BK	240V	Black
SE7255 WH	240V	White
SE7255 SL	240V	Silver
SE7255 BK	240V	Black

## LED SURFACE FITTING

### SE7013 MOD

#### CONSTRUCTION

- Stainless steel face panel
- Powder coated finish (SE7013 BK)
- Opal acrylic diffuser
- E27 lamp base
- Lamp NOT included

#### IP RATING

- IP44 weatherproof

#### LAMP OPTIONS

- LG5, LG9
- LGS4, LGS8, LGS10, LGS14D
- LT407, LT409

Model No.	Input	Fitting Colour	Lamp Base
SE7013 BK	240V	Black	E27
SE7013 SLS	240V	Stainless Steel	E27



#### DIMENSIONS

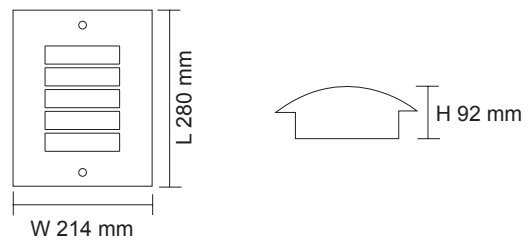

## LED SURFACE FITTING

### SE7273 LUCIA

#### CONSTRUCTION

- UV stabilized shockproof polycarbonate body
- UV stabilised opal polycarbonate diffuser
- Double insulation 
- E27 lamp base
- Lamp NOT included

#### IP RATING

- IP66 weatherproof

#### LAMP OPTIONS

- LG5
- LGS4, LGS8
- LT407

Model No.	Input	Fitting Colour
SE7273 WH	240V	White
SE7273 BK	240V	Black



#### DIMENSIONS

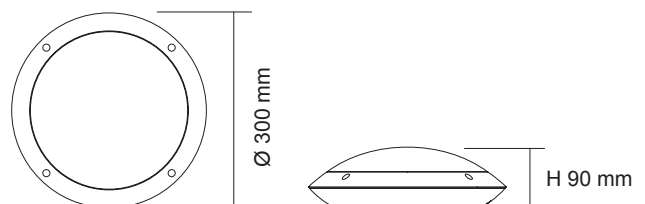

# LED BUNKER LIGHT

## SL7269, SL7270 BUTTON

**IP65**



### DIMENSIONS

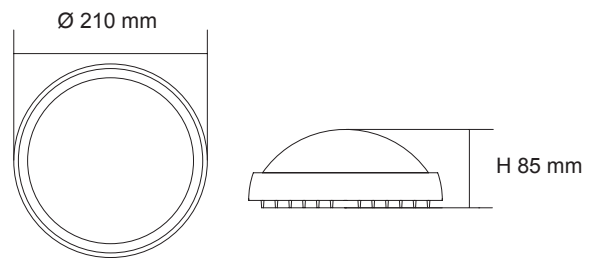
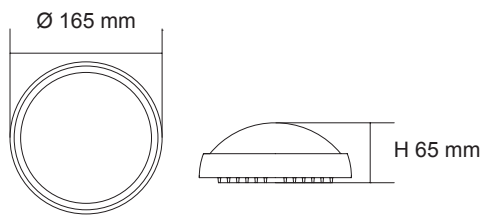

### CONSTRUCTION

- Die-cast aluminium body
- Powder coated finish
- Opal polycarbonate diffuser
- High efficiency SMD LED chips
- Built-in constant current non-dimmable LED driver

### IP RATING

- IP65 weatherproof

### FITTING COLOUR

- White
- Black

Model No.	Input	Power	Lumen	CCT	CRI	Fitting Colour
SL7269DL WH	240V	6W	450lm	5000K	>80	White
SL7269DL BK	240V	6W	450lm	5000K	>80	Black

Model No.	Input	Power	Lumen	CCT	CRI	Fitting Colour
SL7270DL WH	240V	12W	800lm	5000K	>80	White
SL7270DL BK	240V	12W	800lm	5000K	>80	Black

# LED SURFACE LIGHT

## SL9712, SL9712/40 VENICE

**IP64**

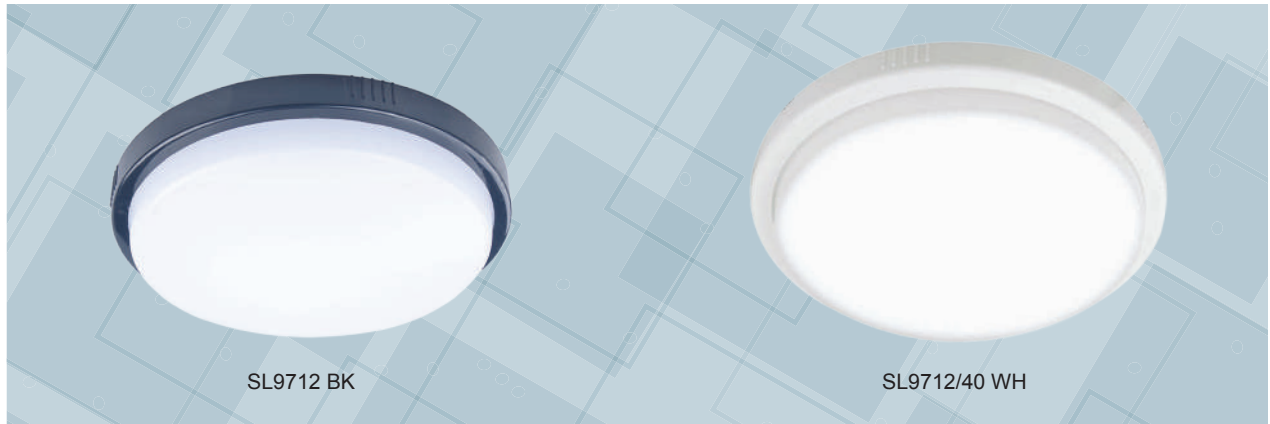

### DIMENSIONS

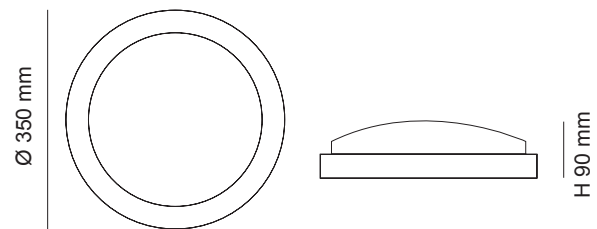
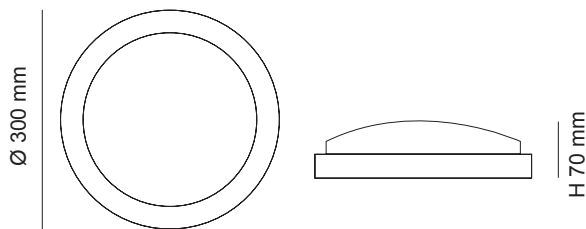

### CONSTRUCTION

- Polycarbonate base and ring
- Double insulation
- Opal polycarbonate diffuser
- High efficiency SMD LED chips
- Constant current non-dimmable LED driver fitted

### IP RATING

- IP64 weatherproof

### DIMMING OPTIONS

- Trailing edge

Model No.	Input	Power	Lumen	CCT	CRI	Fitting Colour
SL9712 WH	240V	13W	900lm	4000K	>85	White
SL9712 CH	240V	13W	900lm	4000K	>85	Chrome
SL9712 SL	240V	13W	900lm	4000K	>85	Silver
SL9712 BL	240V	13W	900lm	4000K	>85	Black

Model No.	Input	Power	Lumen	CCT	CRI	Fitting Colour
SL9712/40 SL	240V	24W	1800lm	4000K	>80	Silver
SL9712/40 WH	240V	24W	1800lm	4000K	>80	White
SL9712/40 BK	240V	24W	1800lm	4000K	>80	Black

### AVAILABLE RING COLOURS



# LED COMMERCIAL SURFACE LIGHT

## SL9719SQ MEMPHIS SQUARE

## SL9719RD MEMPHIS ROUND



### DIMENSIONS

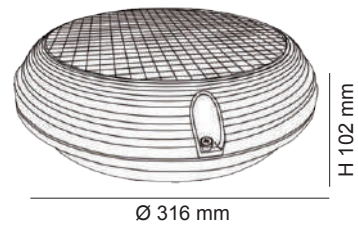
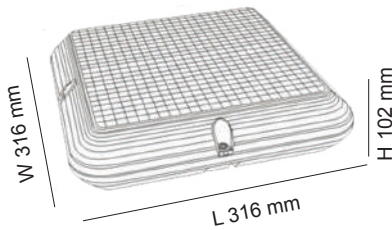

### CONSTRUCTION

- Die-cast aluminium body
- Frosted prismatic polycarbonate diffuser
- Stainless steel allen screws
- Silicone gasket
- High efficiency SMD LED chips
- Constant current non-dimmable LED driver fitted

### IP RATING

- IP65 weatherproof

### DIMMING OPTIONS

- Trailing edge

### SENSOR OPTIONS

- Integrated microwave motion sensor

### EMERGENCY OPTIONS

- Compliant to AS2293
- Emergency classification: D40 (SL9719RD)



Model No.	Input	Power	Lumen	CCT	CRI	Fitting Colour
SL9719SQ	240V	22W	1700lm	4000K	>80	White
SL9719RD	240V	22W	1700lm	4000K	>80	White

# LED COMMERCIAL BUNKER LIGHT

## SE7081L, SE7082L COOPER



### DIMENSIONS

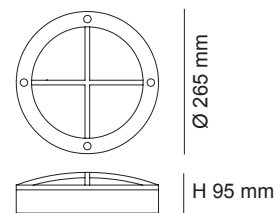
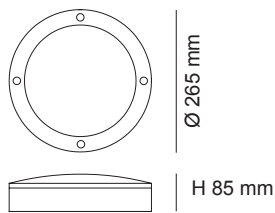

### CONSTRUCTION

- Die-cast aluminium body
- Powder coated finish
- UV stabilised opal polycarbonate diffuser
- Stainless steel allen screws
- Silicon gasket
- High efficiency SMD LED chips
- Constant current non-dimmable LED driver fitted

### IP RATING

- IP65 weatherproof

### SENSOR OPTIONS

- Integrated microwave sensor

### DIMMING OPTIONS

- Trailing edge

### EMERGENCY OPTIONS

- Compliant to AS2293
- Emergency classification:  
D32 (SE7083L/EM)  
D25 (SE7084L/EM)



Model No.	Input	Power	Lumen	CCT	CRI	Fitting Colour
SE7081L SL WW	240V	16W	1100lm	3000K	>80	Silver
SE7081L SL DL	240V	16W	1100lm	6000K	>80	Silver
SE7081L BK WW	240V	16W	1100lm	3000K	>80	Black
SE7081L BK DL	240V	16W	1100lm	6000K	>80	Black
SE7082L SL WW	240V	16W	1000lm	3000K	>80	Silver
SE7082L SL DL	240V	16W	1000lm	6000K	>80	Silver
SE7082L BK WW	240V	16W	1000lm	3000K	>80	Black
SE7082L BK DL	240V	16W	1000lm	6000K	>80	Black

### PHOTOMETRIC DATA Unit: cd C0/C180 — C90/C270

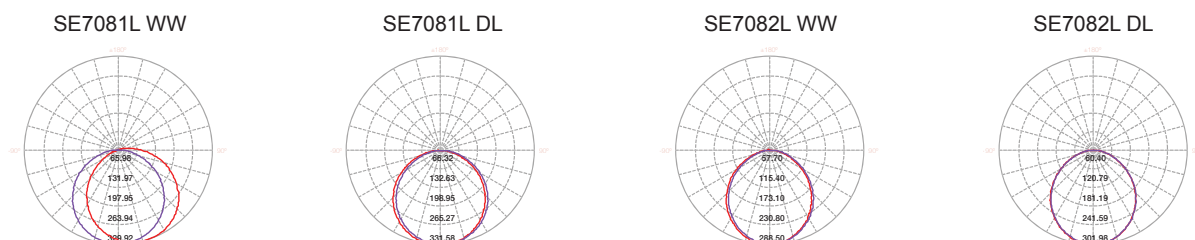



# SE7083L, SE7084L COOPER



## DIMENSIONS

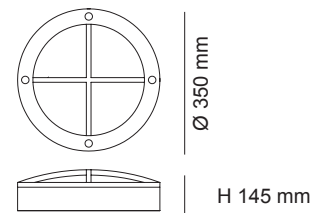
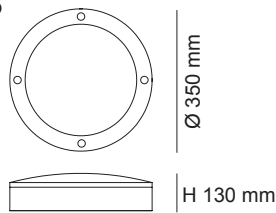

Model No.	Input	Power	Lumen	CCT	CRI	Fitting Colour
SE7083L SL WW	240V	23W	1400lm	3000K	>80	Silver
SE7083L SL DL	240V	23W	1500lm	6000K	>80	Silver
SE7083L BK WW	240V	23W	1400lm	3000K	>80	Black
SE7083L BK DL	240V	23W	1500lm	6000K	>80	Black
SE7084L SL WW	240V	23W	1300lm	3000K	>80	Silver
SE7084L SL DL	240V	23W	1400lm	6000K	>80	Silver
SE7084L BK WW	240V	23W	1300lm	3000K	>80	Black
SE7084L BK DL	240V	23W	1400lm	6000K	>80	Black

## EMERGENCY SPECIFICATION: D32

Model No.	Input	Power	Lumen	CCT	CRI	Fitting Colour
SE7083L/EM/WW/SL	240V	23W/3W	1400lm/250lm	3000K	>80	Silver
SE7083L/EM/DL/SL	240V	23W/3W	1500lm/250lm	6000K	>80	Silver
SE7083L/EM/WW/BK	240V	23W/3W	1400lm/250lm	3000K	>80	Black
SE7083L/EM/DL/BK	240V	23W/3W	1500lm/250lm	6000K	>80	Black

## EMERGENCY SPECIFICATION: D25

Model No.	Input	Power	Lumen	CCT	CRI	Fitting Colour
SE7084L/EM/WW/SL	240V	23W/3W	1300lm/230lm	3000K	>80	Silver
SE7084L/EM/DL/SL	240V	23W/3W	1400lm/230lm	6000K	>80	Silver
SE7084L/EM/WW/BK	240V	23W/3W	1300lm/230lm	3000K	>80	Black
SE7084L/EM/DL/BK	240V	23W/3W	1400lm/230lm	6000K	>80	Black

## PHOTOMETRIC DATA Unit: cd C0/C180 — C90/C270

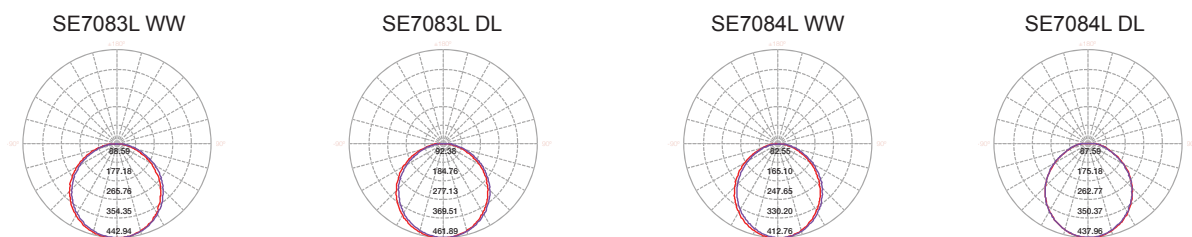

# LED BUNKER LIGHT

## SE7087L REC-BUNKER

### CONSTRUCTION

- Die-cast aluminium body
- Powder coated finish
- Opal polycarbonate diffuser
- Stainless steel screws
- Silicon gasket
- High efficiency SMD LED chips
- Constant current non-dimmable LED driver fitted

### IP RATING

- IP54 weatherproof

### DIMMING OPTIONS

- Trailing edge



### DIMENSIONS

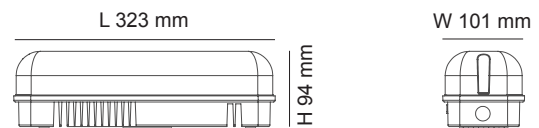

Model No.	Input	Power	Lumen	CCT	Beam Angle	CRI	Fitting Colour
SE7087L	240V	18W	1450lm	4000K	90°	>80	White

# LED WALL LIGHT

## SE7089 BRONX

### CONSTRUCTION

- Die-cast aluminium body
- Powder coated finish
- UV stabilised opal polycarbonate diffuser
- High efficiency COB LED chip
- Polished aluminium reflector
- Built-in constant current non-dimmable LED driver
- IP66 PVC cable gland
- Stainless steel allen screws
- 450 mm 3 core rubber flex

### IP RATING

- IP65 weatherproof

### SENSOR OPTIONS

- Integrated microwave motion sensor



### DIMENSIONS

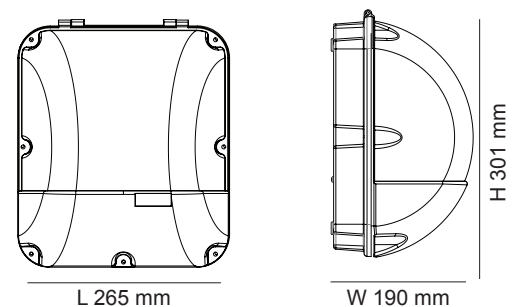

Model No.	Input	Power	Lumen	CCT	CRI	Fitting Colour
SE7089BK	240V	55W	4500lm	5000K	>70	Black

# LED PORTABLE WORK LIGHT

## SE7073 FLEX



### DIMENSIONS

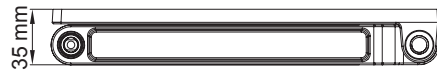
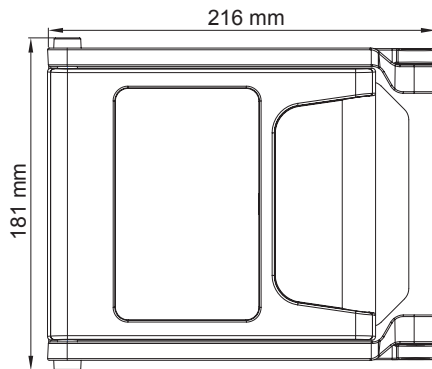

### CONSTRUCTION

- Portable & rechargeable
- Twin output levels: 100% and 50%
- 4 hour battery life at 50% output from full charge (100% output = 2 hours)
- Adjustable free standing frame
- Complete with 240V plug-in charger

### IP RATING

- IP44 weatherproof

### FITTING COLOURS AVAILABLE

- Red
- Yellow

Model No.	Input	Power	Lumen	CCT	Beam Angle	CRI	Fitting Colour	Dimmable
SE7073NDL/RD	9V	10W	600lm	5000K	120°	>80	Red	Stepped
SE7073NDL/YW	9V	10W	600lm	5000K	120°	>80	Yellow	Stepped



ON/OFF, 50%, 100% switches



SE7073 folded



Plug-in charger



# LED RECESSED WALL FITTING

## SL7262, SL7267 NEWPORT



### CONSTRUCTION

- Die-cast aluminium or stainless steel body
- Powder coated finish
- Clear glass cover
- Installation canister included
- GU5.3 lamp base
- Lamp NOT included
- 12V AC or DC transformer required

### IP RATING

- IP65 weatherproof

### LAMP OPTIONS

- MR16 5W
- MR16/7W
- MR16DIM9W

### DIMENSIONS

SL7262

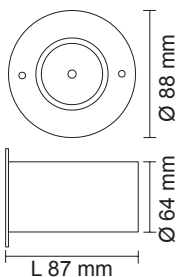

Installation canister

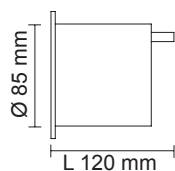

SL7267

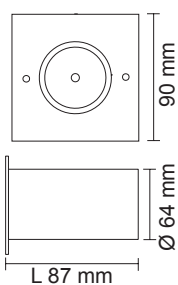

Installation canister

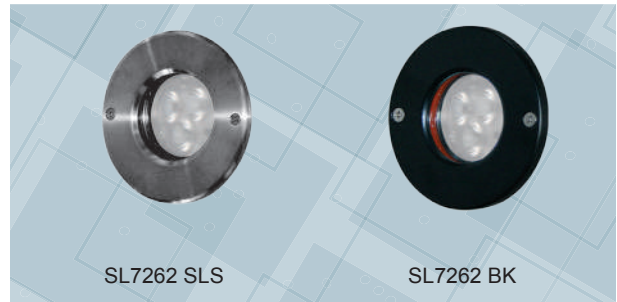
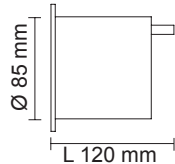

### INSTALLATION CANISTER

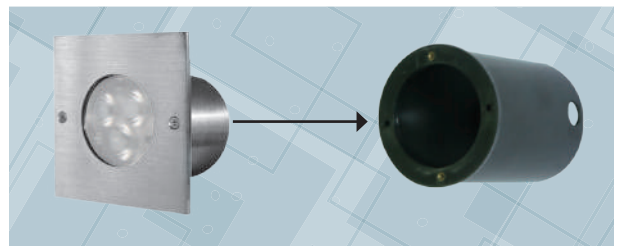

Model No.	Input	Lamp Base	Fitting Colour
SL7262 BK	12V	GU5.3	Black
SL7262 SL	12V	GU5.3	Silver
SL7262 SA	12V	GU5.3	Stainless Steel Cover
SL7262 SLS	12V	GU5.3	Stainless Steel

Model No.	Input	Lamp Base	Fitting Colour
SL7267 BK	12V	GU5.3	Black
SL7267 SL	12V	GU5.3	Silver
SL7267 SA	12V	GU5.3	Stainless Steel Cover
SL7267 SLS	12V	GU5.3	Stainless Steel

# LED RECESSED WALL FITTING

## SL7263, SL7268 NEWPORT



### CONSTRUCTION

- Die-cast aluminium or stainless steel body
- Powder coated finish
- Clear glass cover
- Installation canister included
- GU5.3 lamp base
- Lamp NOT included
- 12V AC or DC transformer required

### IP RATING

- IP65 weatherproof

### LAMP OPTIONS

- MR16 5W
- MR16/7W
- MR16DIM9W

### DIMENSIONS

SL7263

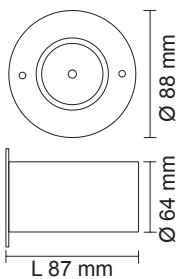

Installation canister

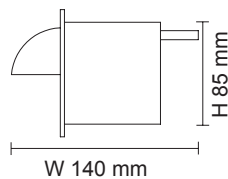

SL7268

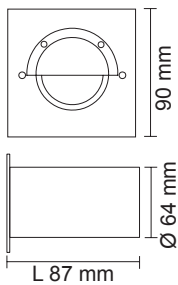

Installation canister

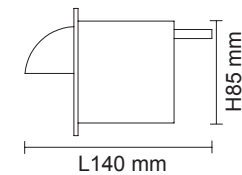

### INSTALLATION CANISTER ATTACHED

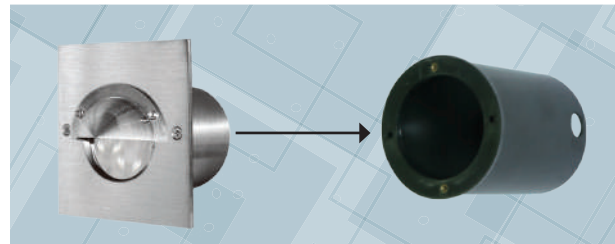

Model No.	Input	Lamp Base	Fitting Colour
SL7263 BK	12V	GU5.3	Black
SL7263 SL	12V	GU5.3	Silver
SL7263 SA	12V	GU5.3	Stainless Steel Cover
SL7263 SLS	12V	GU5.3	Stainless Steel

Model No.	Input	Lamp Base	Fitting Colour
SL7268 BK	12V	GU5.3	Black
SL7268 SL	12V	GU5.3	Silver
SL7268 SA	12V	GU5.3	Stainless Steel Cover
SL7268 SLS	12V	GU5.3	Stainless Steel

# LED BRICK WALL LIGHT

## SE7135 MAXI LOUVERED

## SE7136 MAXI SLOT

## SE7137 MAXI EYELID



### DIMENSIONS

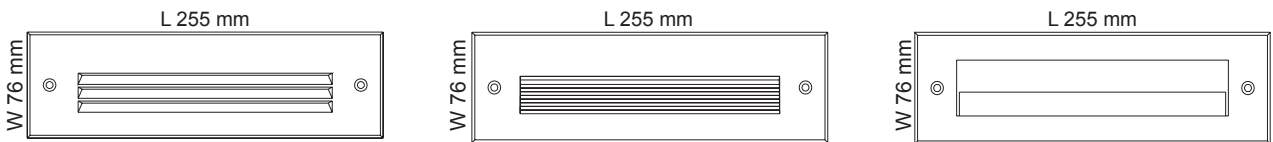

### CONSTRUCTION

- Die-cast aluminium body and powder coated face cover (SE7135, SE7136, SE7137)
- Die-cast aluminium body and stainless steel face cover (SE7138, SE7139)
- Opal polycarbonate diffuser
- High efficiency SMD LED chips
- Built in non-dimmable LED driver
- Silicone gasket
- IP68 PVC cable gland
- Stainless steel allen screws
- ABS installation canister included

### CANISTER INSTALLATION INSTRUCTIONS

- A1 & A2 are the support plates used during the construction installation process to prevent deformation of the installation canister
- Slot in A1 & A2 plates during construction
- Please remove the support plates (A1 & A2) before final installation

Installation canister: L 235 mm x W 65 mm

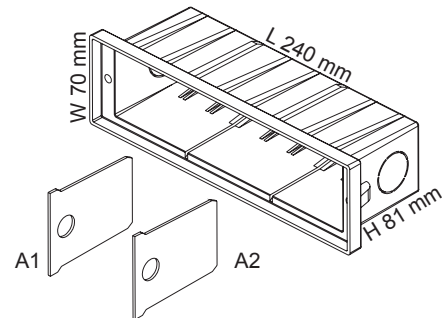

### IP RATING

- IP65 weatherproof

### PHOTOMETRIC DATA Unit: cd C0/C180 — C90/C270

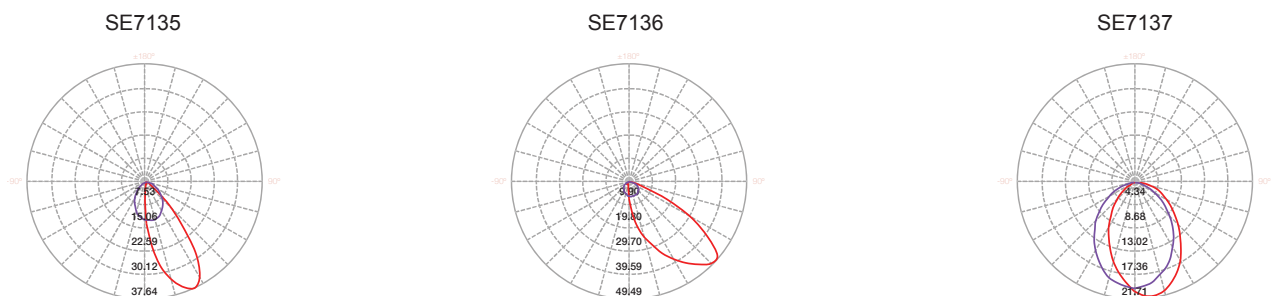



# LED BRICK WALL LIGHT

## SE7138 MAXI GRILLED

## SE7139 MAXI PLAIN

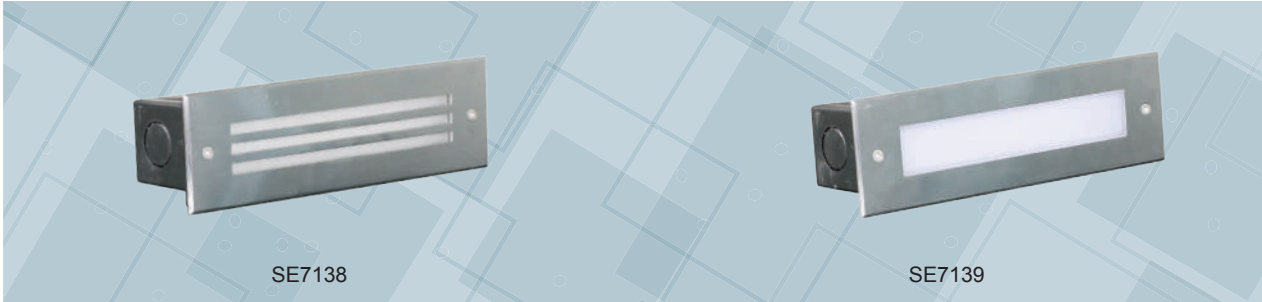

### DIMENSIONS

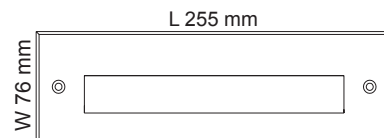
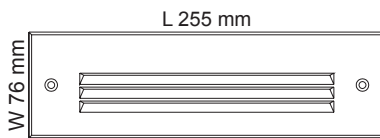

Model No.	Input	Power	Lumen	CCT	CRI	Fitting Colour
SE7135WW/BK	240V	7W	80lm	3000K	>80	Black
SE7135WW/SL	240V	7W	80lm	3000K	>80	Silver
SE7135CW/BK	240V	7W	80lm	4000K	>80	Black
SE7135CW/SL	240V	7W	80lm	4000K	>80	Silver
SE7136WW/BK	240V	7W	60lm	3000K	>80	Black
SE7136WW/SL	240V	7W	60lm	3000K	>80	Silver
SE7136CW/BK	240V	7W	60lm	4000K	>80	Black
SE7136CW/SL	240V	7W	60lm	4000K	>80	Silver
SE7137WW/BK	240V	7W	50lm	3000K	>80	Black
SE7137WW/SL	240V	7W	50lm	3000K	>80	Silver
SE7137CW/BK	240V	7W	50lm	4000K	>80	Black
SE7137CW/SL	240V	7W	50lm	4000K	>80	Silver
SE7138WW	240V	7W	80lm	3000K	>80	Stainless Steel
SE7138CW	240V	7W	80lm	4000K	>80	Stainless Steel
SE7139WW	240V	7W	140lm	3000K	>80	Stainless Steel
SE7139CW	240V	7W	140lm	4000K	>80	Stainless Steel

### PHOTOMETRIC DATA Unit: cd C0/C180 — C90/C270

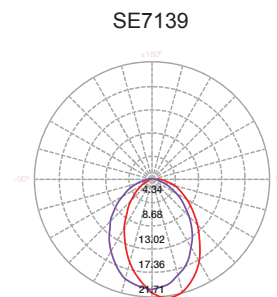
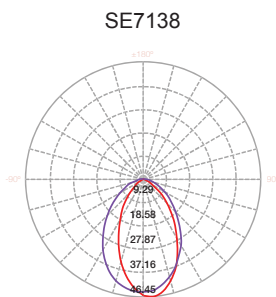

# LED RECESSED WALL LIGHT

## SE7140 LOUVERED

## SE7141 SLOT

## SE7142 PLAIN

**IP65**

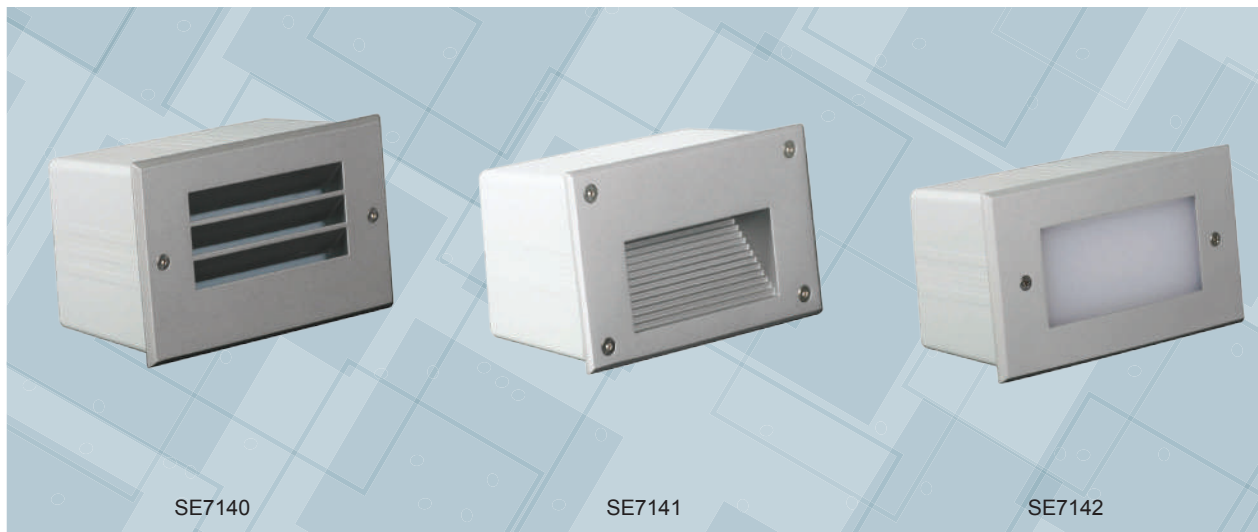

### DIMENSIONS



Installation canister: L 158 mm x W 84 mm

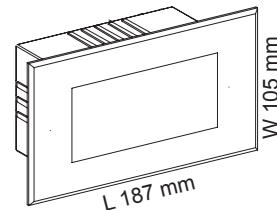
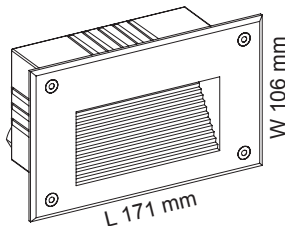
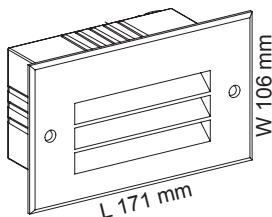
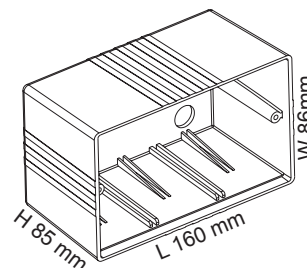
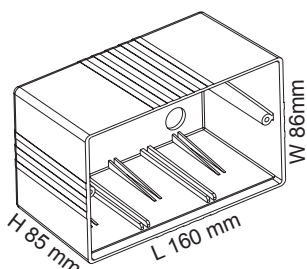
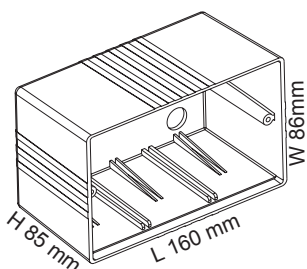

### CONSTRUCTION

- Die-cast aluminium body and face cover
- Powder coated finish
- Opal polycarbonate diffuser
- High efficiency SMD LED chips
- Built in non-dimmable LED driver

- Silicone gasket
- IP67 nickel coated copper cable gland
- Stainless steel allen screws
- PVC installation canister included

### IP RATING

- IP65 weatherproof

## CANISTER INSTALLATION INSTRUCTIONS

- A1 & A2 are the support plates used during the construction installation process to prevent deformation of the installation canister
- Slot in A1 & A2 plates during construction
- Please remove the support plates (A1 & A2) before final installation



Installation canister: L 235 mm x W 65 mm

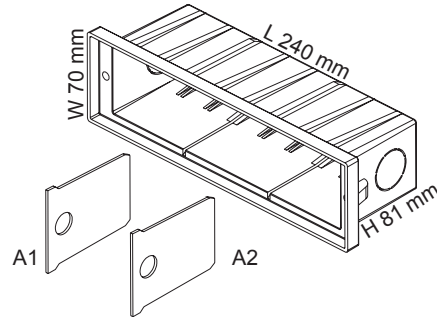

Model No.	Input	Power	Lumen	CCT	CRI	Fitting Colour
SE7140WW/BK	240V	3W	50lm	3000K	>80	Black
SE7140WW/SL	240V	3W	50lm	3000K	>80	Silver
SE7140CW/BK	240V	3W	50lm	4000K	>80	Black
SE7140CW/SL	240V	3W	50lm	4000K	>80	Silver

Model No.	Input	Power	Lumen	CCT	CRI	Fitting Colour
SE7141WW/BK	240V	3W	60lm	3000K	>80	Black
SE7141WW/SL	240V	3W	60lm	3000K	>80	Silver
SE7141CW/BK	240V	3W	60lm	4000K	>80	Black
SE7141CW/SL	240V	3W	60lm	4000K	>80	Silver

Model No.	Input	Power	Lumen	CCT	CRI	Fitting Colour
SE7142WW/BK	240V	3W	80lm	3000K	>80	Black
SE7142WW/SL	240V	3W	80lm	3000K	>80	Silver
SE7142CW/BK	240V	3W	80lm	4000K	>80	Black
SE7142CW/SL	240V	3W	80lm	4000K	>80	Silver

## PHOTOMETRIC DATA Unit: cd C0/C180 — C90/C270

SE7140

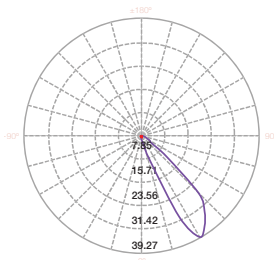

SE7141

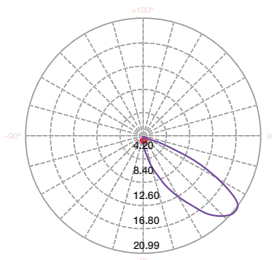

SE7142

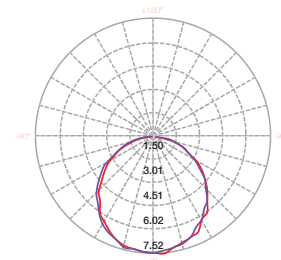

# LED WALL FITTING

## SE7121, SE7122, SE7123 BONDI



### CONSTRUCTION

- Machined 316L stainless steel or cast aluminium body
- Powder coated finish (Black, Silver)
- Clear tempered glass cover
- GU10 lamp base
- GU10L350 Lamp included

### IP RATING

- IP65 weatherproof

### LAMP OPTIONS

- GU10L550
- GU10LR750 (excluding stainless steel fitting)
- GU10LA750 (excluding stainless steel fitting)

See Lamp section for detail

### DIMENSIONS

SE7121/GU10

SE7122/GU10

SE7123/GU10

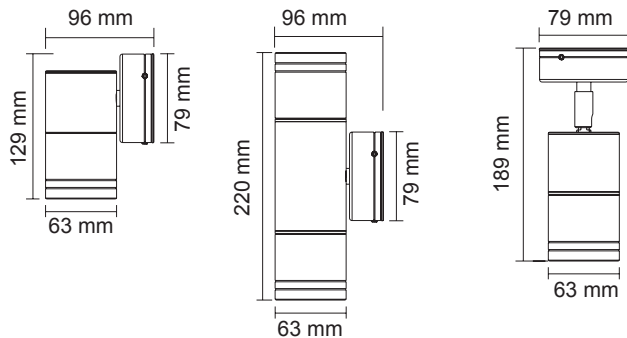

Model No.	Input	Material	Fitting Colour
SE7121SLS GU10	240V	Machined 316L stainless steel	Stainless Steel
SE7121BK GU10	240V	Die cast aluminium	Black
SE7121SL GU10	240V	Die cast aluminium	Silver
SE7122SLS GU10	240V	Machined 316L stainless steel	Stainless Steel
SE7122BK GU10	240V	Die cast aluminium	Black
SE7122SL GU10	240V	Die cast aluminium	Silver
SE7123SLS GU10	240V	Machined 316L stainless steel	Stainless Steel
SE7123BK GU10	240V	Die cast aluminium	Black
SE7123SL GU10	240V	Die cast aluminium	Silver



# LED WALL FITTING

## SE7133, SE7134 ETON

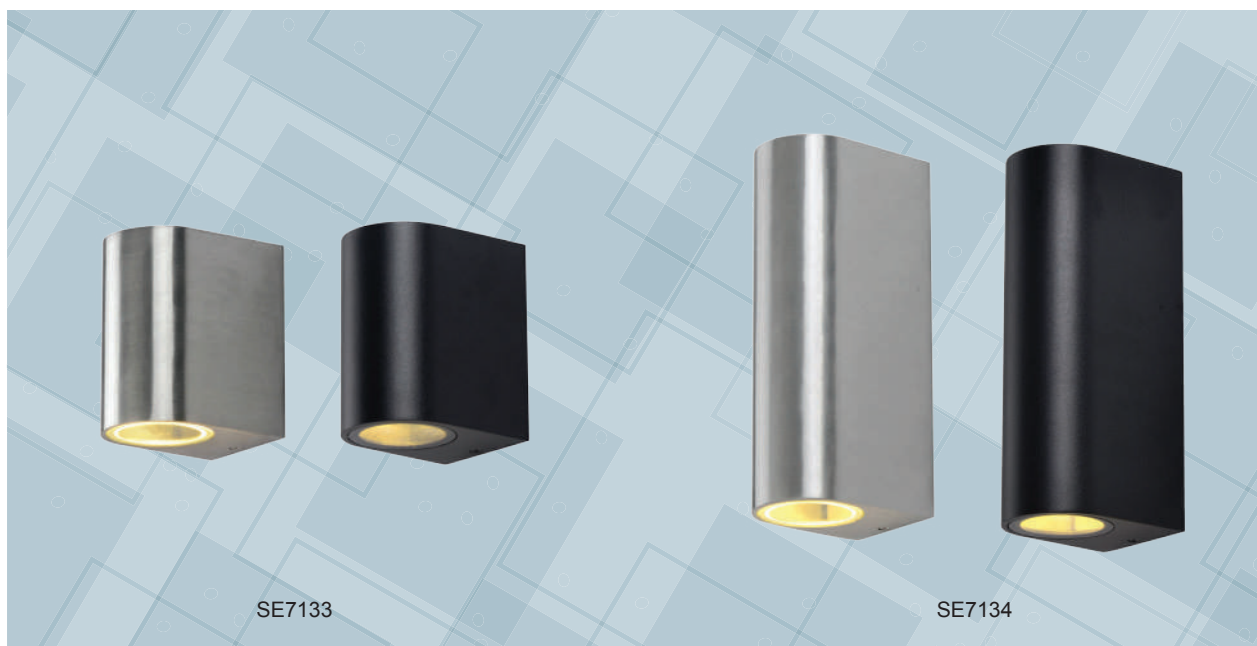

### DIMENSIONS

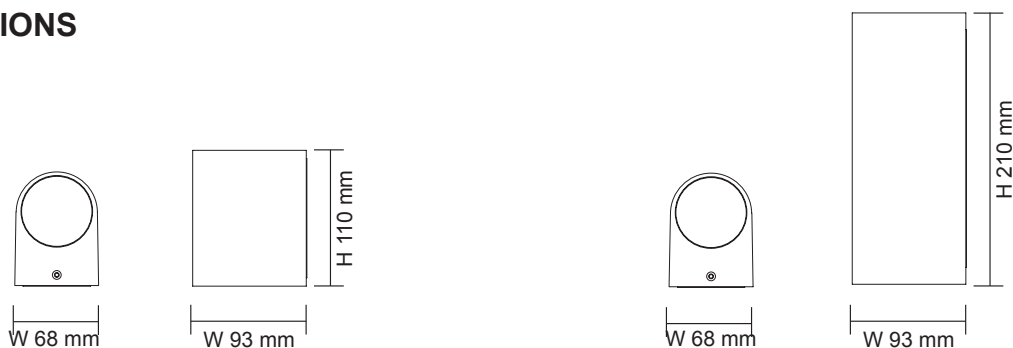

### CONSTRUCTION

- Die-cast aluminium body
- Powder coated finish
- Clear tempered glass cover
- GU10 lamp base
- Lamp NOT included

### LAMP OPTIONS

- GU10L350
- GU10L550
- GU10LR750
- GU10LA750

### IP RATING

- IP54 weatherproof

Model No.	Input	Fitting Colour	Number of Lamps required
SE7133BK GU10	240V	Black	1
SE7133SL GU10	240V	Silver	1
SE7134BK GU10	240V	Black	2
SE7134SL GU10	240V	Silver	2

# LED WALL FITTING

## SE7131, SE7132 NEW FLINDERS WALL



### DIMENSIONS



### CONSTRUCTION

- Premium aluminium body
- Powder coated finish
- Clear tempered glass cover
- GU10 lamp base
- Lamp NOT included

### IP RATING

- IP54 weatherproof

### LAMP OPTIONS

- GU10L350
- GU10L550
- GU10LR750
- GU10LA750

Model No.	Input	Fitting Colour	Number of Lamps required
SE7131BK GU10	240V	Black	1
SE7131CB GU10	240V	Charcoal Black	1
SE7132BK GU10	240V	Black	2
SE7132CB GU10	240V	Charcoal Black	2

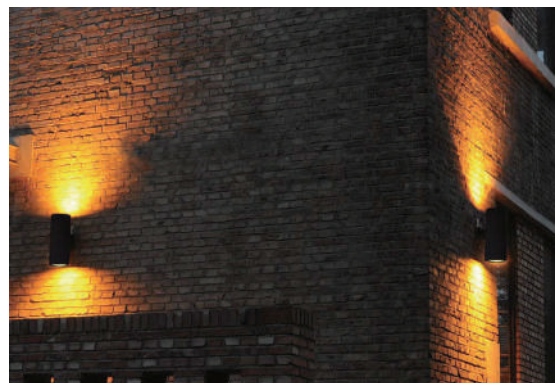



# LED WALL LIGHT

## SL7221, SL7222

### NEW BONDI



#### CONSTRUCTION

- Premium aluminium body
- Powder coated finish
- Clear tempered glass cover
- GU10 lamp base
- Lamp NOT included

#### IP RATING

- IP65 weatherproof

#### LAMP OPTIONS

- GU10L350
- GU10L550
- GU10LR750
- GU10LA750

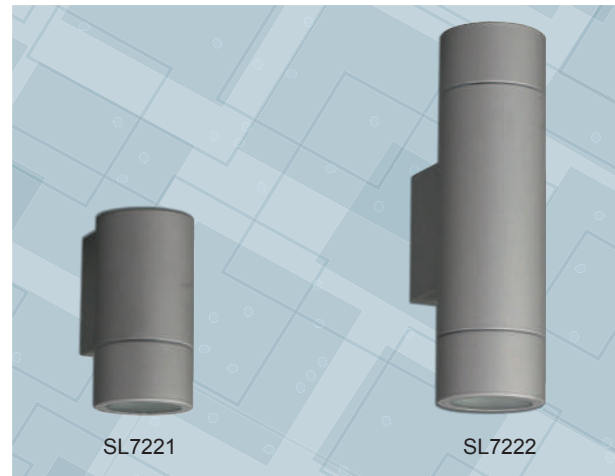

#### DIMENSIONS

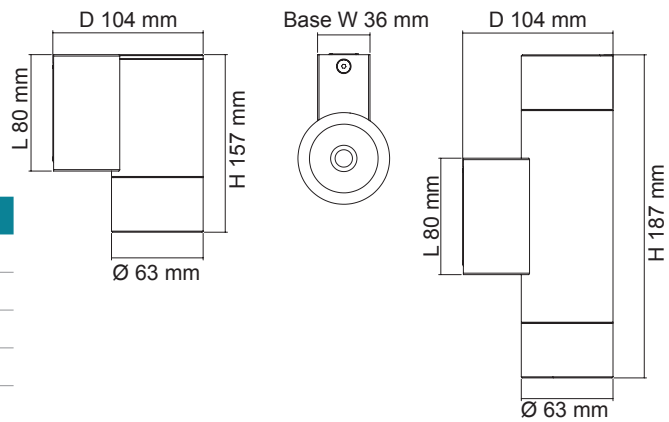

Model No.	Input	Fitting Colour
SL7221GU AS	240V	Anodized Silver
SL7221GU BK	240V	Black
SL7221GU SL	240V	Silver
SL7222GU AS	240V	Anodized Silver
SL7222GU BK	240V	Black
SL7222GU SL	240V	Silver

# LED WALL LIGHT

## SE7062 LACHLAN WALL

#### CONSTRUCTION

- Die-cast aluminium body
- Powder coated finish
- Clear glass diffuser
- High output SMD LED chip
- Built-in constant current non-dimmable LED driver

#### IP RATING

- IP54 weatherproof



#### DIMENSIONS



Model No.	Input	Power	Lumen	CCT	Beam Angle	CRI	Fitting Colour
SE7062 BK	240V	7W	600lm	5000K	120° x 2	>80	Black
SE7062 CB	240V	7W	600lm	5000K	120° x 2	>80	Charcoal Black



# LED WALL LIGHT

## SL7223, SL7224 NEW BONDI II

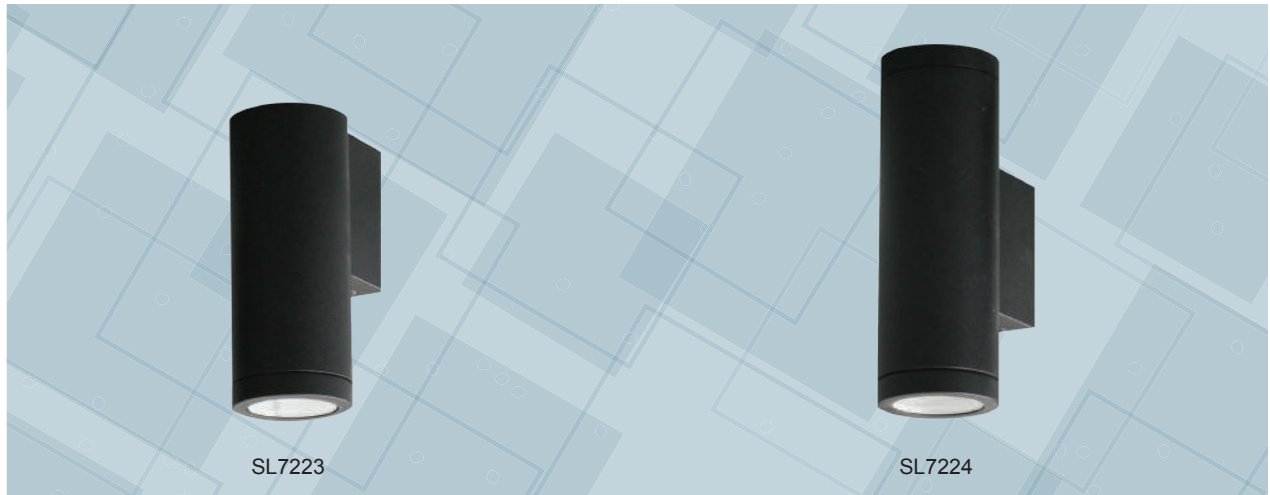

### DIMENSIONS

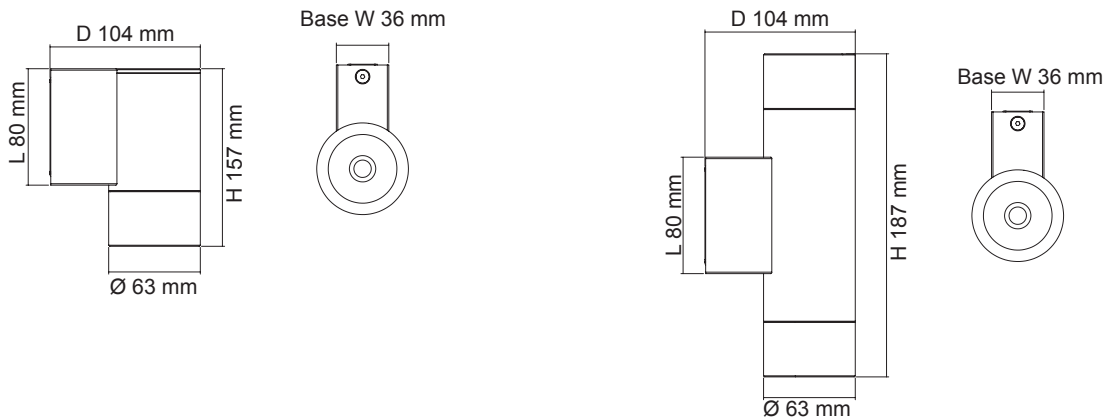

### CONSTRUCTION

- Premium aluminium body
- Powder coated finish
- Clear tempered glass cover
- Polycarbonate optical lens
- High efficiency SMD LED chips
- Built-in constant current non-dimmable LED driver

### IP RATING

- IP65 weatherproof

### COLOUR TEMPERATURE

- 3000K Warm White
- 4000K Cool White
- 6000K Daylight

Model No.	Input	Power	Lumen	CCT	Beam Angle	CRI	Fitting Colour
SL7223WW/BK	240V	6W	400lm	3000K	38°	>80	Black
SL7223WW/SL	240V	6W	400lm	3000K	38°	>80	Silver
SL7224WW/BK	240V	11W	2 x 400lm	3000K	38°	>80	Black
SL7224WW/SL	240V	11W	2 x 400lm	3000K	38°	>80	Silver

### PHOTOMETRIC DATA SL7223WW UNIT: cd C0/C180

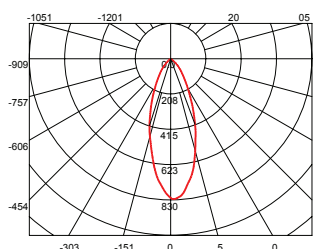

# LED WALL LIGHT

## SE7145 SCOOP



### CONSTRUCTION

- Die-cast aluminium body
- Powder coated finish
- Clear glass cover
- High output COB LED chip
- High performance multi-reflector system
- Stainless steel allen screws
- Built-in constant current non-dimmable LED driver

### IP RATING

- IP65 weatherproof

### BEAM OPTION

- Can be installed upward or downward facing



### DIMENSIONS

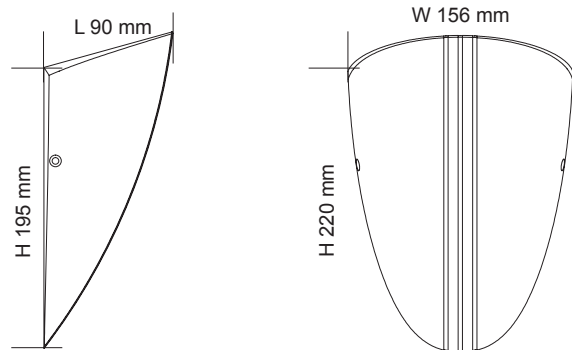

Model No.	Input	Power	Lumen	CCT	Beam Angle	CRI	Fitting Colour
SE7145WW/BK	240V	15W	800lm	3000K	30°	>80	Black
SE7145WW/SL	240V	15W	800lm	3000K	30°	>80	Silver
SE7145CW/BK	240V	15W	900lm	4000K	30°	>80	Black
SE7145CW/SL	240V	15W	900lm	4000K	30°	>80	Silver

### PHOTOMETRIC DATA

Unit: cd C0/C180 — C90/C270

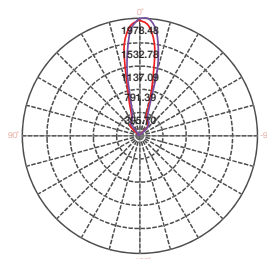

# LED WALL LIGHT

## SE7146 QUARTER

**IP65**

### CONSTRUCTION

- Die-cast aluminium body
- Powder coated finish
- Clear tempered glass cover
- High output COB LED chip
- High performance multi-reflector system
- Stainless steel allen screws
- Built-in constant current non-dimmable LED driver

### IP RATING

- IP65 weatherproof

### BEAM OPTION

- Can be installed downward facing only



### DIMENSIONS

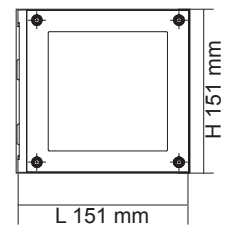
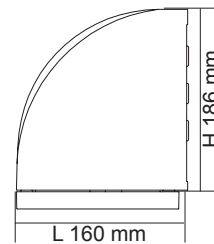

Model No.	Input	Power	Lumen	CCT	Beam Angle	CRI	Fitting Colour
SE7146WW/BK	240V	16W	1150lm	3000K	25°	>80	Black
SE7146WW/CB	240V	16W	1150lm	3000K	25°	>80	Charcoal Black
SE7146CW/BK	240V	16W	1200lm	4000K	25°	>80	Black
SE7146CW/CB	240V	16W	1200lm	4000K	25°	>80	Charcoal Black

### PHOTOMETRIC DATA

Unit: cd C0/C180 \_\_\_\_\_ C90/C270 \_\_\_\_\_

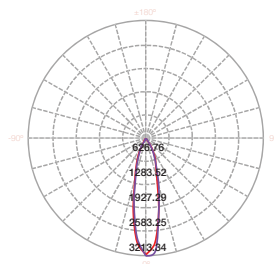

# LED WALL LIGHT

## SE7147 MINI STEIN



### CONSTRUCTION

- Die-cast aluminium body
- Powder coated finish
- Clear tempered glass cover
- High output COB LED chip
- High performance multi-reflector system
- Built-in constant current non-dimmable LED driver
- Stainless steel allen screws

### IP RATING

- IP65 weatherproof

### BEAM STANDARD

- Upward & downward



SE7147 CB

### DIMENSIONS

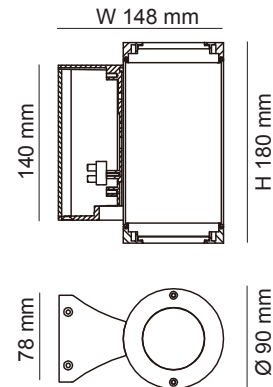

### BEAM OPTION

- Can be installed upward or downward facing



Model No.	Input	Power	Lumen	CCT	Beam Angle	CRI	Fitting Colour
SE7147WW/BK	240V	16W	2 x 400lm	3000K	25°	>80	Black
SE7147WW/CB	240V	16W	2 x 400lm	3000K	25°	>80	Charcoal Black
SE7147CW/BK	240V	16W	2 x 400lm	4000K	25°	>80	Black
SE7147CW/CB	240V	16W	2 x 400lm	4000K	25°	>80	Charcoal Black

### PHOTOMETRIC DATA Unit: cd C0/C180 \_\_\_\_\_ C90/C270 \_\_\_\_\_

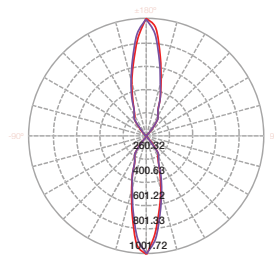

# LED WALL LIGHT

## SE7148 STEIN

### CONSTRUCTION

- Die-cast aluminium body
- Powder coated finish
- Clear tempered glass cover
- High output COB LED chip
- High performance multi-reflector system
- Built-in constant current non-dimmable LED driver
- Stainless steel allen screws

### IP RATING

- IP65 weatherproof

### BEAM STANDARD

- Upward & downward



### BEAM OPTION

- Can be installed upward or downward facing



### DIMENSIONS

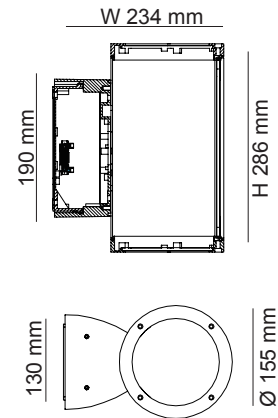

Model No.	Input	Power	Lumen	CCT	Beam Angle	CRI	Fitting Colour
SE7148WW/BK	240V	32W	2 x 800lm	3000K	25°	>80	Black
SE7148WW/CB	240V	32W	2 x 800lm	3000K	25°	>80	Charcoal Black
SE7148CW/BK	240V	32W	2 x 800lm	4000K	25°	>80	Black
SE7148CW/CB	240V	32W	2 x 800lm	4000K	25°	>80	Charcoal Black

Model No.	Input	Power	Lumen	CCT	Beam Angle	CRI	Fitting Colour
SE7148NB/WW BK	240V	32W	800lm/500lm	3000K	25°/Narrow Beam	>80	Black
SE7148NB/WW CB	240V	32W	800lm/500lm	3000K	25°/Narrow Beam	>80	Charcoal Black
SE7148NB/CW BK	240V	32W	800lm/500lm	4000K	25°/Narrow Beam	>80	Black
SE7148NB/CW CB	240V	32W	800lm/500lm	4000K	25°/Narrow Beam	>80	Charcoal Black

### PHOTOMETRIC DATA SE7148WW Unit: cd C0/C180 — C90/C270 —

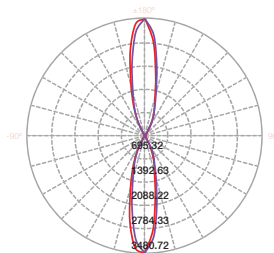



# LED SURFACE LIGHT

## SE7088 ANGLE

### CONSTRUCTION

- Die-cast aluminium body
- Powder coated finish
- Adjustable head 0~90°
- Silicone gasket
- Clear tempered glass cover
- High output COB LED chip
- High performance multi-reflector system
- Built-in constant current non-dimmable LED driver

### IP RATING

- IP65 weatherproof



### DIMENSIONS

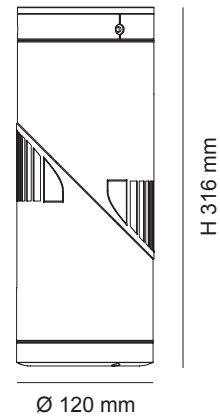

Model No.	Input	Power	Lumen	CCT	Beam Angle	CRI	Fitting Colour
SE7088 BK	240V	18W	1500lm	3000K	40°	>80	Black
SE7088 CB	240V	18W	1500lm	3000K	40°	>80	Charcoal Black

### PHOTOMETRIC DATA

Unit: cd C0/C180 \_\_\_\_\_ C90/C270 \_\_\_\_\_

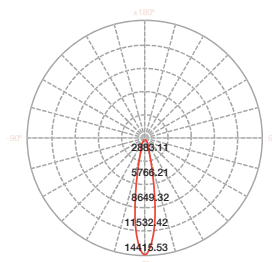

# LED SURFACE LIGHT

## SE7188 PILLAR



### DIMENSIONS

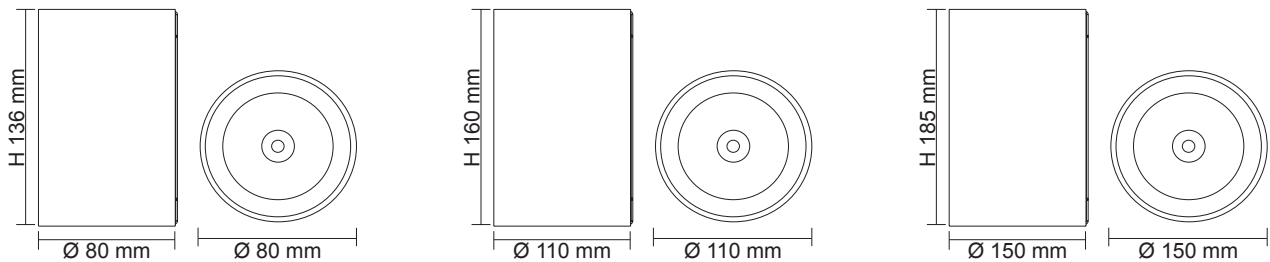

### CONSTRUCTION

- Surface mounted downlight with no-screw outside fitting provides a much cleaner design
- Clear tempered glass cover
- High output COB LED chip
- Changeable high performance multi-reflector system
- Built-in constant current non-dimmable LED driver

### IP RATING

- IP65 weatherproof

### BEAM ANGLE

- 30° (standard)
- S9603/80: 10°, 20°, 40°, 50° (option)
- S9603/110: 10°, 20°, 40°, 70° (option)
- S9603/150: 12°, 20°, 40°, 70° (option)

### COLOUR TEMPERATURE

- 4000K Cool White (standard)
- 3000K Warm White (option)
- 5000K Neutral Daylight (option)



Model No.	Input	Power	Lumen	CCT	Beam Angle	CRI	Fitting Colour	Dimension Ø x H
SE7188/80/20CW	240V	20W	2000lm	4000K	30°	>80	Black	80 x 136 mm
SE7188/110/25CW	240V	20W	2500lm	4000K	30°	>80	Black	110 x 160 mm
SE7188/110/34CW	240V	28W	3400lm	4000K	30°	>80	Black	110 x 160 mm
SE7188/150/42CW	240V	34W	4200lm	4000K	30°	>80	Black	150 x 185 mm
SE7188/150/49CW	240V	38W	4900lm	4000K	30°	>80	Black	150 x 185 mm
SE7188/150/62CW	240V	62W	6200lm	4000K	30°	>80	Black	150 x 185 mm

## PHOTOMETRIC DATA

UNIT: cd C0/C180 — C60/240 — C90/270 —

SE7188/80/20CW (20°)

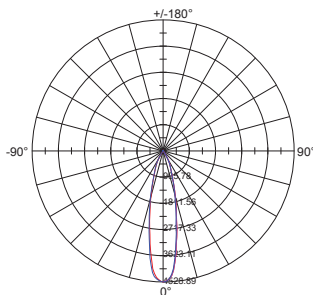

SE7188/110/34CW (30°)

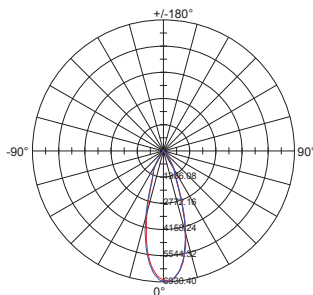

SE7188/150/62CW (70°)

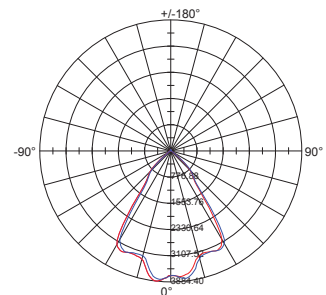

# LED WALL & POST FITTING

## SE7006, SE7016, SE7007, SE7017, SE7008, SE7018, SE7009, SE7019 MURRAY I

### CONSTRUCTION

- Stainless steel body
- Powder coated finish (black)
- Opal acrylic diffuser
- E27 lamp base
- Lamp NOT included

### IP RATING

- IP44 weatherproof

### LAMP OPTIONS

- LG5, LG9
- LGS4, LGS8, LGS10
- LT407, LT409

### DIMENSIONS

SE7016 SE7006

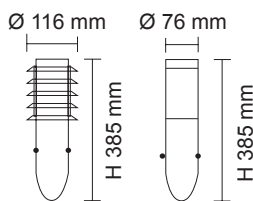

SE7017

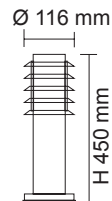

SE7007

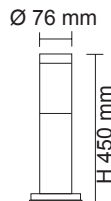

SE7019 SE7009

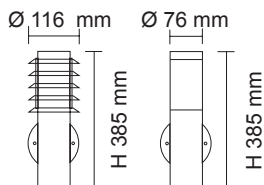

SE7018

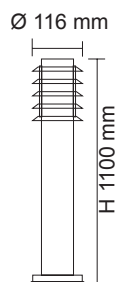

SE7008

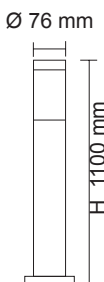

Model No.	Input	Fitting Colour
SE7006 SLS	240V	Stainless Steel
SE7006 BK	240V	Black
SE7016 SLS	240V	Stainless Steel
SE7016 BK	240V	Black
SE7007 SLS	240V	Stainless Steel
SE7007 BK	240V	Black
SE7017 SLS	240V	Stainless Steel
SE7017 BK	240V	Black

Model No.	Input	Fitting Colour
SE7008 SLS	240V	Stainless Steel
SE7008 BK	240V	Black
SE7018 SLS	240V	Stainless Steel
SE7018 BK	240V	Black
SE7009 SLS	240V	Stainless Steel
SE7009 BK	240V	Black
SE7019 SLS	240V	Stainless Steel
SE7019 BK	240V	Black

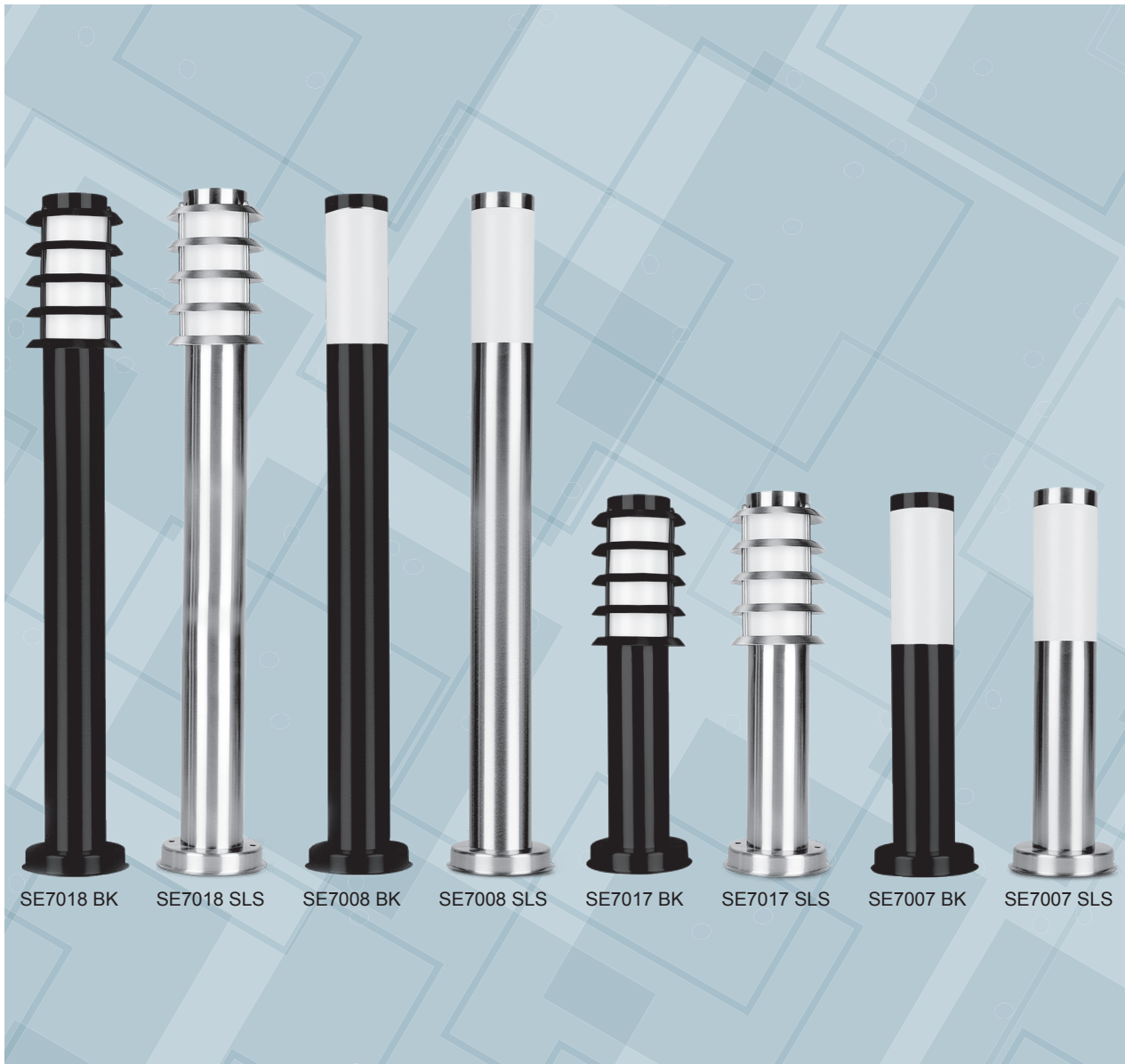

SE7018 BK

SE7018 SLS

SE7008 BK

SE7008 SLS

SE7017 BK

SE7017 SLS

SE7007 BK

SE7007 SLS

# LED SPOT LIGHT

## S9353, S9354 TORCH

**IP65**

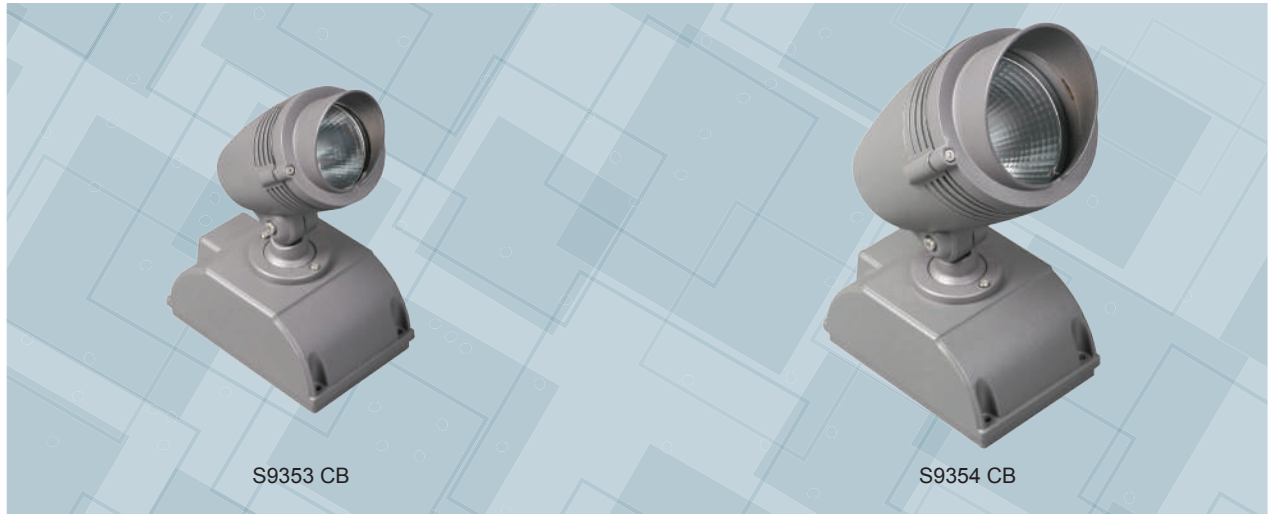

S9353 CB

S9354 CB

### DIMENSIONS

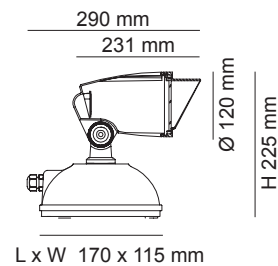
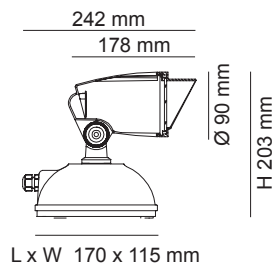

### CONSTRUCTION

- Die-cast aluminium body
- Powder coated finish
- Clear tempered glass diffuser
- High output COB LED chip
- High performance multi-reflector system
- Built-in constant current non-dimmable LED driver

- IP66 PVC cable gland
- Stainless steel allen screws
- 500 mm 3 core PVC flex

### IP RATING

- IP65 weatherproof

Model No.	Input	Power	Lumen	CCT	CRI	Beam Angle	Fitting Colour
S9353WW/BK	240V	16W	1200lm	3000K	>80	25°	Black
S9353CW/BK	240V	16W	1200lm	4000K	>80	25°	Black
S9353WW/CB	240V	16W	1200lm	3000K	>80	25°	Charcoal Black
S9353CW/CB	240V	16W	1200lm	4000K	>80	25°	Charcoal Black

Model No.	Input	Power	Lumen	CCT	CRI	Beam Angle	Fitting Colour
S9354WW/BK	240V	22W	1500lm	3000K	>80	25°	Black
S9354CW/BK	240V	22W	1500lm	4000K	>80	25°	Black
S9354WW/CB	240V	22W	1500lm	3000K	>80	25°	Charcoal Black
S9354CW/CB	240V	22W	1500lm	4000K	>80	25°	Charcoal Black



# LED SPIKE LIGHT

## SL7266 MINI SPIKE

### CONSTRUCTION

- Die-cast aluminium body
- Powder coated finish
- High output COB LED chip with aluminium reflector
- 12V AC or DC driver required
- 1.5 m 2 core rubber flex

### IP RATING

- IP65 weatherproof



### DIMENSIONS

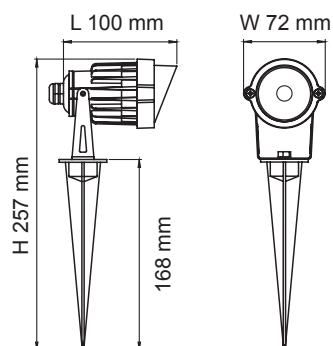

Model No.	Input	Power	Lumen	CCT	CRI	Beam Angle	Fitting Colour
SL7266WW/BK	12V	6W	400lm	3000K	>80	30°	Black

# LED RECESSED WALL LIGHT

## S9337 BREMER

### CONSTRUCTION

- Die-cast aluminium body
- Stainless steel face panel & screws
- ABS installation canister included
- Clear tempered glass cover
- High output SMD LED chip
- Built-in constant current non-dimmable LED driver
- 500 mm 3 core rubber flex

### IP RATING

- IP44 weatherproof



### DIMENSIONS

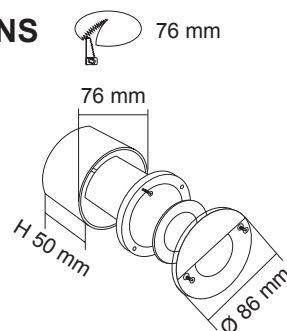

Model No.	Input	Power	Lumen	CCT	CRI	Fitting Colour
S9337	240V	2W	140lm	3000K	>80	Stainless Steel

# LED SPIKE LIGHT

## SL7261, SL7264 NEWPORT SPIKE



### DIMENSIONS

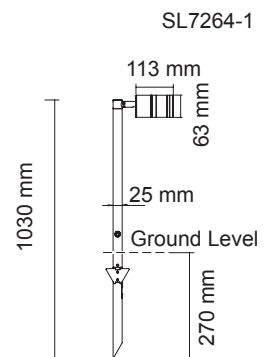
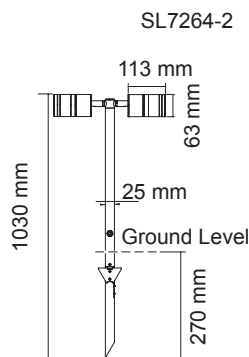
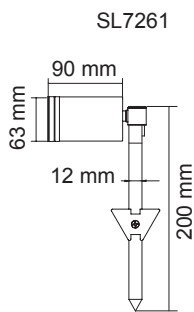

### CONSTRUCTION

- Machined 316L stainless steel or extruded aluminium body
- Clear tempered glass cover
- GU5.3 lamp base
- MR16 5W lamp included
- 600 mm 2 core rubber flex
- 12V AC or DC driver required

### IP RATING

- IP54 weatherproof

### LAMP OPTIONS

- MR16/7W
- MR16DIM9W (excluding Stainless Steel fittings)

Model No.	Input	Lamp Base	Material	Fitting Colour	Type
SL7261 SLS	12V	GU5.3	Machined 316L Stainless Steel	Stainless Steel	Single Head
SL7261 SL	12V	GU5.3	Extruded Aluminium	Silver	Single Head
SL7261 BK	12V	GU5.3	Extruded Aluminium	Black	Single Head
SL7261 AS	12V	GU5.3	Extruded Aluminium	Anodized Silver	Single Head

Model No.	Input	Lamp Base	Material	Fitting Colour	Type
SL7264/40-1 SLS	12V	GU5.3	Machined 316L Stainless Steel	Stainless Steel	Single Head
SL7264/40-1 SL	12V	GU5.3	Extruded Aluminium	Silver	Single Head
SL7264/40-1 BK	12V	GU5.3	Extruded Aluminium	Black	Single Head

Model No.	Input	Lamp Base	Material	Fitting Colour	Type
SL7264/40-2 SLS	12V	GU5.3	Machined 316L Stainless Steel	Stainless Steel	Twin Head
SL7264/40-2 SL	12V	GU5.3	Extruded Aluminium	Silver	Twin Head
SL7264/40-2 BK	12V	GU5.3	Extruded Aluminium	Black	Twin Head

# LED WALL & POST FITTING

## SE7085, SE7086 SWAN

### CONSTRUCTION

- Stainless steel body
- Clear acrylic diffuser
- E27 lamp base
- Lamp NOT included

### IP RATING

- IP44 weatherproof

### LAMP OPTIONS

- LG5, LG9
- LGS4, LGS8, LGS10
- LT407, LT409

Model No.	Input	Fitting Colour
SE7085	240V	Stainless Steel
SE7086/55	240V	Stainless Steel
SE7086/100	240V	Stainless Steel

### DIMENSIONS

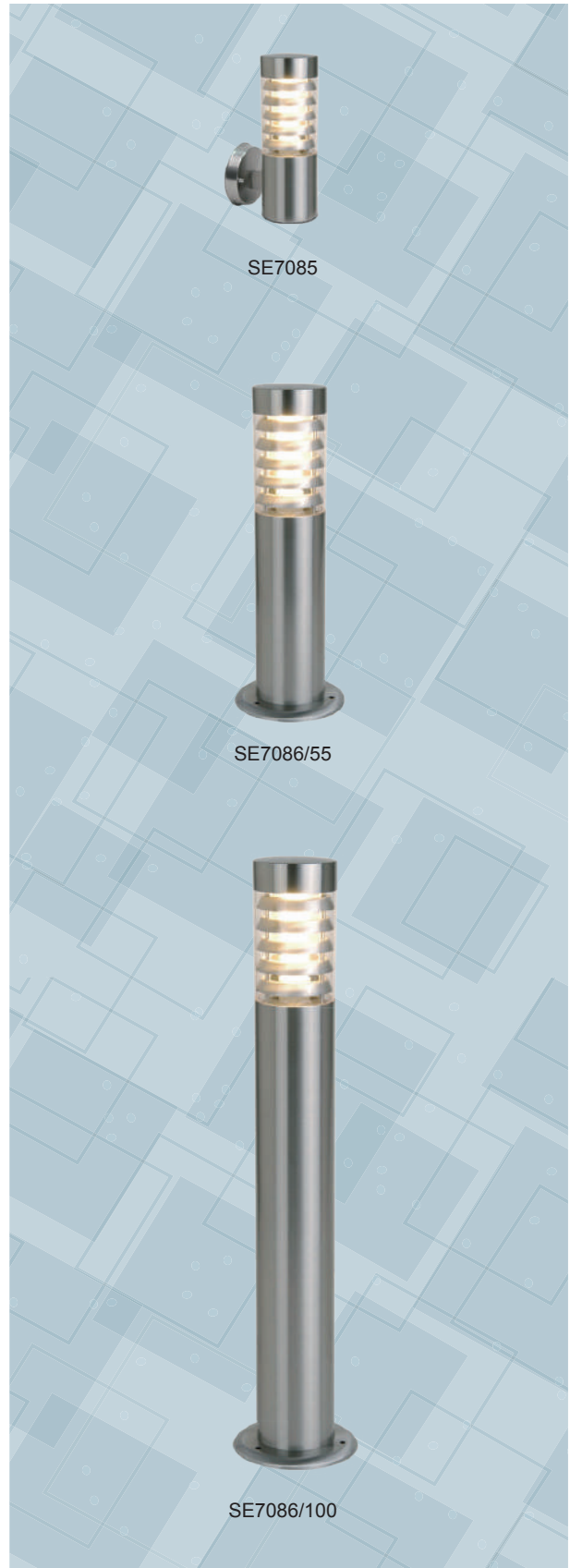
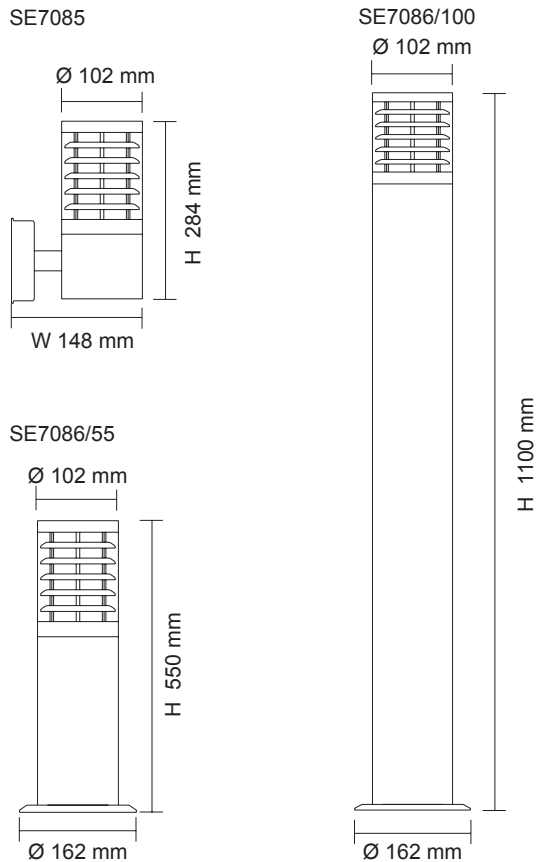

# LED POST LIGHT

## SE7061 NEW FLINDERS POST

### CONSTRUCTION

- Extruded aluminium body
- Powder coated finish
- Opal polycarbonate diffuser
- GX53 LED lamp included or built-in low voltage SMD LED chips (12V AC or DC driver required)

### IP RATING

- IP54 weatherproof

### DIMENSIONS

SE7061/500

SE7061/800

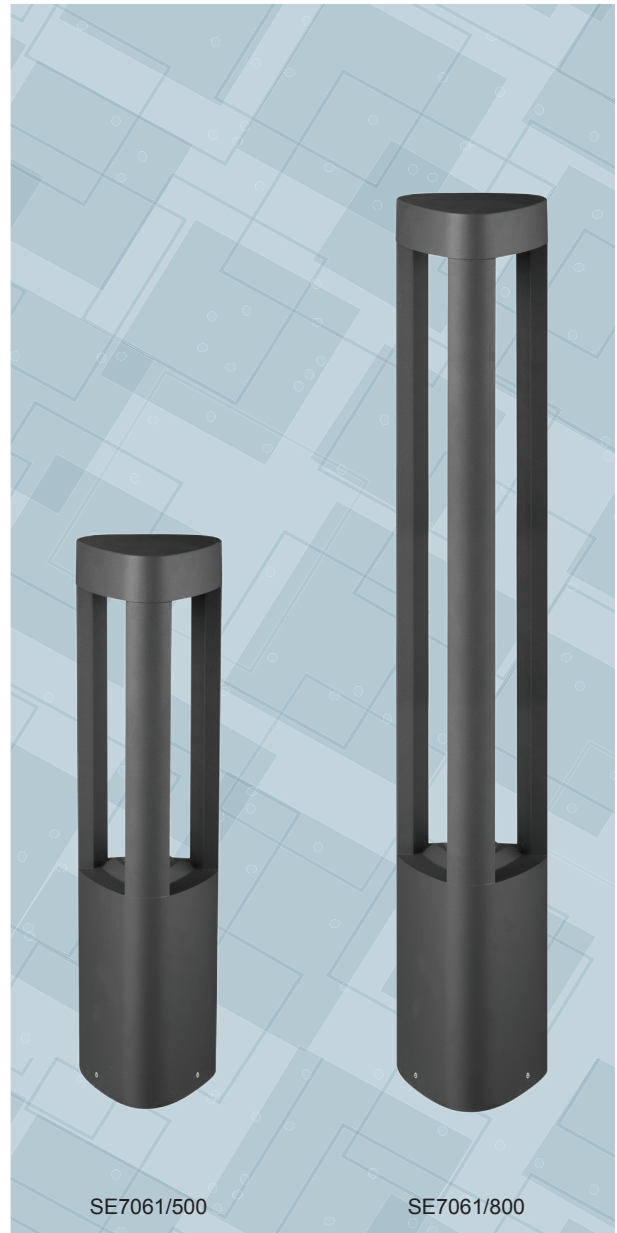
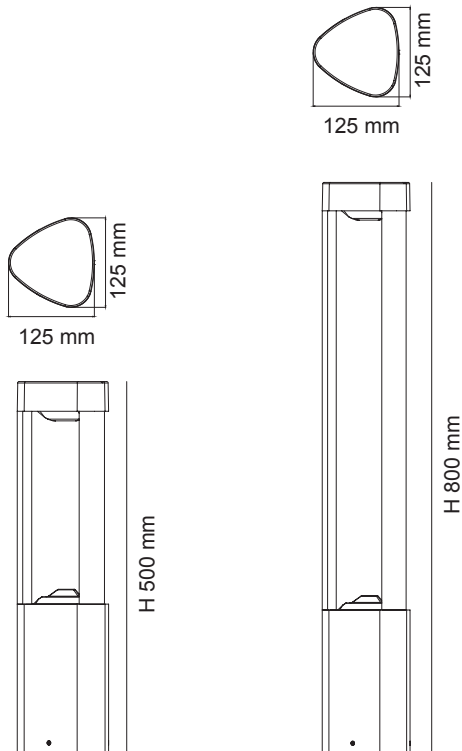

Model No.	Input	Power	Lumen	CCT	Lamp Base	Fitting Colour
SE7061/500 BK	240V	3W	450lm	6000K	GX53	Black
SE7061/500 LV BK	12V	6W	500lm	6000K	N/A	Black
SE7061/800 BK	240V	5W	450lm	6000K	GX53	Black
SE7061/800 LV BK	12V	6W	500lm	6000K	N/A	Black

# LED POST LIGHT

## SLA7102, SE7102/LGLS BOLLARD

### CONSTRUCTION

- Die-cast aluminium body
- Powder coated finish
- Clear polycarbonate diffuser

### SLA7102 BOLLARD

- Matt aluminium reflector
- High efficiency SMD LED chips
- Built-in constant current non-dimmable LED driver

### SE7102/LGLS BOLLARD

- Stainless steel reflector
- E27 lamp base
- LED lamp NOT included

### IP RATING

- IP54 weatherproof

### LAMP OPTIONS (SE7102/LGLS)

- LG5, LG9
- LGS4, LGS8, LGS10
- LT407, LT409

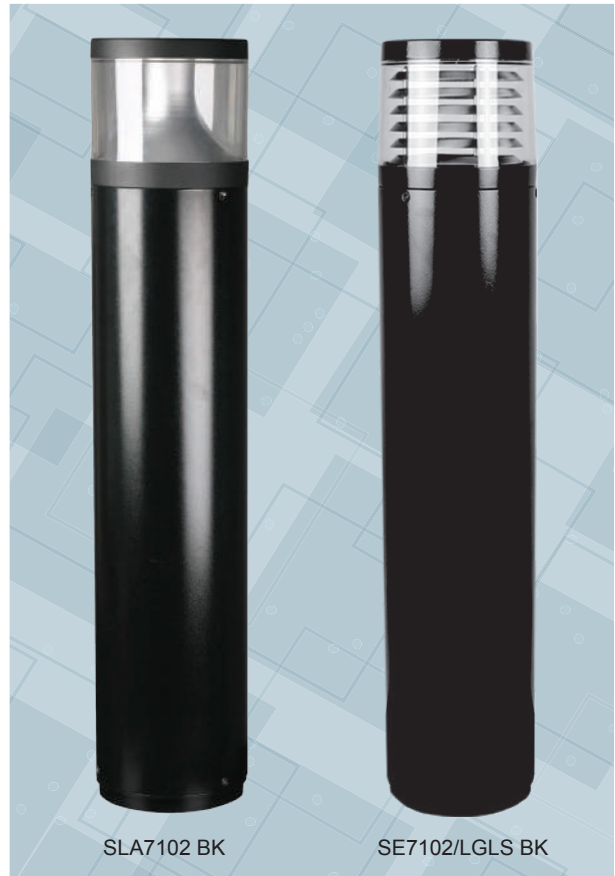

### DIMENSIONS

Ø 203 mm

Ø 203 mm

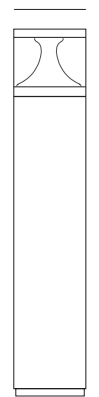

H 1000 mm



H 1000 mm

### PHOTOMETRIC DATA

Unit: cd

SLA7102

C0/C180

C90/C270

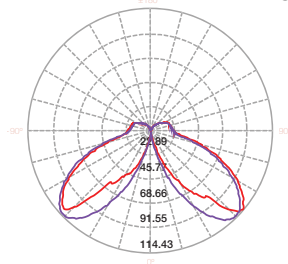

Model No.	Input	Power	Lumen	CCT	CRI	Colour
SLA7102BK	240V	18W	1200lm	6000K	>75	Black
SLA7102SL	240V	18W	1200lm	6000K	>75	Silver

Model No.	Input	Power	Lumen	CCT	Beam Angle	CRI	Colour
SE7102 BK/LGLS							Black
SE7102 SL/LGLS							Silver

Refer to the Lamp, Drivers & Accessories Section of this catalogue

# LED POST FITTING

## SE7103, SE7104, SE7105, SE7106 BOLLARD



### DIMENSIONS

Ø 160 mm



### CONSTRUCTION

- Die-cast aluminium body
- Opal acrylic diffuser
- Matt aluminium reflector (SE7105BK, SE7106BK)
- Powder coated finish
- E27 lamp base
- Lamp NOT included

### IP RATING

- IP54 weatherproof

### SUITABLE LAMP TYPES

- LG5, LG9
- LGS4, LGS8, LGS10
- LT407, LT409

Model No.	Input	Power	Lumen	CCT	Beam Angle	CRI	Light Source	Colour
SE7103BK/LGLS	240V							Black
SE7104BK/LGLS	240V							Black

Refer to the Lamp, Drivers & Accessories Section of this catalogue

Model No.	Input	Power	Lumen	CCT	Beam Angle	CRI	Light Source	Colour
SE7105BK/LGLS	240V							Black
SE7106BK/LGLS	240V							Black

Refer to the Lamp, Drivers & Accessories Section of this catalogue



# LED DECK LIGHT KITS

## SE8001, SE8002, SE8003RGB HAMPTONS



### FEATURES

- IP67 deck lights with IP65 driver
- 10VA 12V DC driver with 2 m rubber flex & 2 pin plug
- High efficiency SMD LED
- Quick connect system
- Ideal for DIY
- Can be extended up to 10 deck lights

## SE8001 HAMPTONS



SE8001 LED deck light kit

SE8001P LED deck light extension kit

### DIMENSIONS

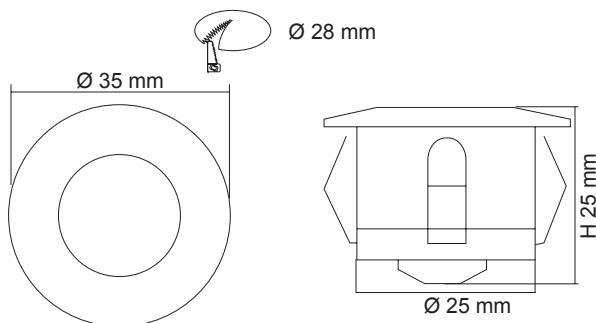

### CONSTRUCTION

- Durable 316L stainless steel face & body
- Clear tempered glass
- Ø35 mm x H25 mm round deck lights
- 6 x 0.6W deck light heads with 3.5 m PVC flex & 2 pin quick connect plug
- 6 m rubber flex with 6 x 2 pin quick connect sockets
- 1 x IP65 10VA driver

### SE8001P

### LED DECK LIGHT EXTENSION KIT

### CONTENTS

- 1 x Ø35 x H25 mm, 316 stainless steel face & body round deck light
- 1 x 3.5 m PVC flex with 2 pin quick connect plug
- 1 x 1.1 m extension cable

Model No.	Power	CCT	CRI	Dimmable
SE8001WW	6 x 0.6W	3000K	>80	No
SE8001NDL	6 x 0.6W	5000K	>80	No

Model No.	Power	CCT	CRI	Dimmable
SE8001P/WW	1 x 0.6W	3000K	>80	No
SE8001P/NDL	1 x 0.6W	5000K	>80	No



# LED DECK LIGHT KITS

## SE8002 HAMPTONS



SE8002 LED deck light kit

SE8002P LED deck light extension kit

### DIMENSIONS

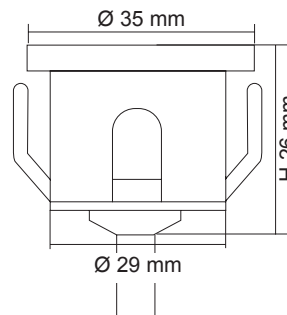
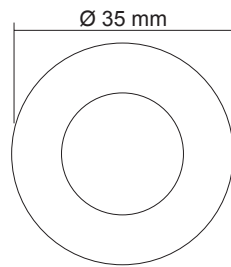
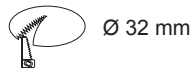

### CONSTRUCTION

- Durable 316 stainless steel face
- Aluminium body
- Frosted polycarbonate diffuser
- Ø35 mm x H26 mm round deck lights
- 6 x 0.6W deck light head with 3.5 m PVC flex & 2 pin quick connect plug
- 6 m rubber flex with 6 x 2 pin quick connect sockets
- 1 x IP65 10VA driver

### SE8002P

### LED DECK LIGHT EXTENSION KIT

### CONTENTS

- 1 x Ø35 x H26 mm, 316 stainless steel face round deck light
- 1 x 3.5 m PVC flex with 2 pin quick connect plug
- 1 x 1.1 m extension cable

Model No.	Power	CCT	CRI	Dimmable
SE8002WW	6 x 0.6W	3000K	>80	No
SE8002NDL	6 x 0.6W	5000K	>80	No

Model No.	Power	CCT	CRI	Dimmable
SE8002P/WW	1 x 0.6W	3000K	>80	No
SE8002P/NDL	1 x 0.6W	5000K	>80	No

# LED DECK LIGHT KITS

## SE8003RGB HAMPTONS

**IP67**



SE8003RGB LED deck light kit

SE8003RGB/P LED deck light extension kit

### DIMENSIONS

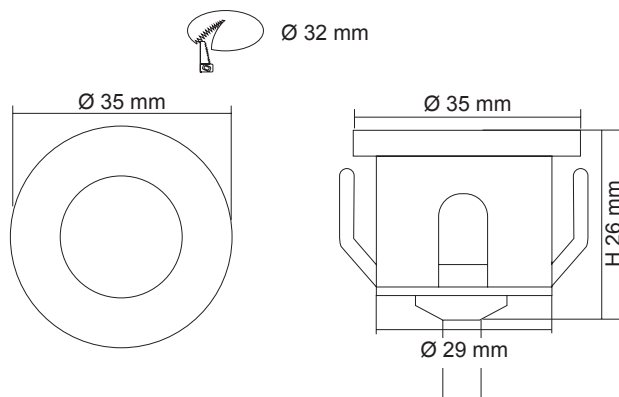

### CONSTRUCTION

- Durable 316 stainless steel face
- Aluminium body
- Frosted polycarbonate diffuser
- Ø35 mm x H26 mm round deck lights
- 6 x 0.2W deck light head with 0.5 m PVC flex & 4 pin quick connect plug
- 10 m rubber flex with 6 x 4 pin quick connect sockets
- 1 x IP65 10VA driver
- Multi-function remote controller included

### SE8003RGB/P LED DECK LIGHT EXTENSION KIT

#### CONTENTS

- 1 x Ø35 x H26 mm, 316 stainless steel face round deck light
- 1 x 0.5 m PVC flex with 4 pin quick connect plug
- 1 x 1.6 m extension cable

Model No.	Power	Dimmable	IP Rating
SE8003RGB	6 x 0.2W	Yes	IP67

Model No.	Power	Dimmable	IP Rating
SE8003RGB/P	1 x 0.2W	Yes	IP67

# LED INGROUND LIGHT

## SL7362 GLOW

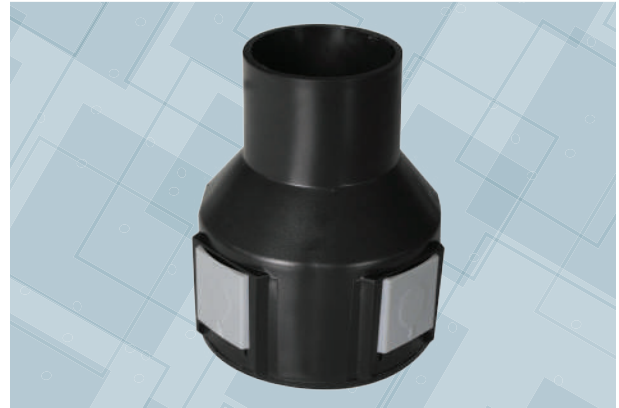
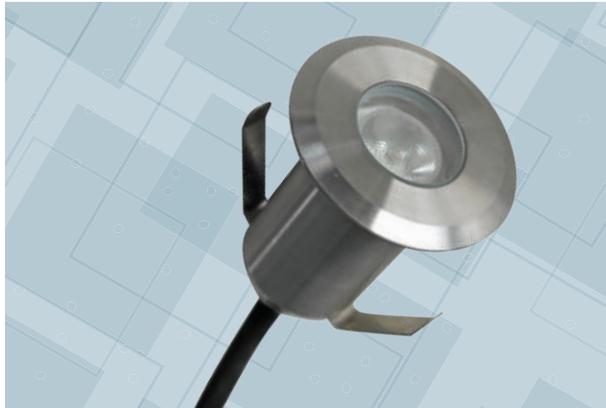

### DIMENSIONS

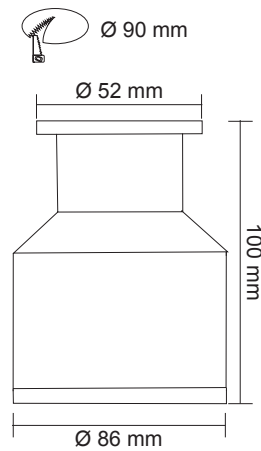
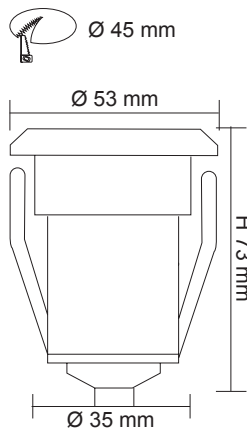

### CONSTRUCTION

- Durable stainless steel body
- Clear tempered glass diffuser
- Frosted optical LED lens
- High output LED chips
- 1 m 2 core rubber flex
- IP67 nickel plated copper cable gland
- Silicon gasket
- PVC installation cannister included
- 12V DC constant voltage driver required

### SUITABLE LED DRIVERS

- PLUTO 30/12V
- PLUTO 100/12V
- PLUTO 200/12V

Model No.	Power	Lumen	CCT	Beam Angle	CRI	Dimmable
SL7362WW/SLS	3W	300lm	6000K	15°	>80	No

# LED INGROUND LIGHT

## S9338 GROUND

**IP67**

### CONSTRUCTION

- Die-cast aluminium body
- Stainless steel face panel & screws
- Clear tempered glass diffuser
- High output LED chip
- 24V AC/DC driver required
- Beam angle 30°
- Lighting direction adjustable between 50°~60°
- PC installation canister included
- 600 mm 2 core rubber flex

### IP RATING

- IP67 weatherproof

### SUITABLE LED DRIVERS

- PLUTO 30/24V
- PLUTO 100/24V
- PLUTO 200/24V

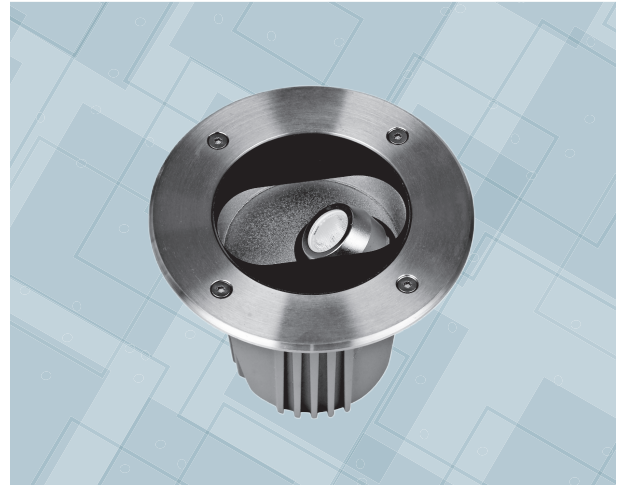

### DIMENSIONS

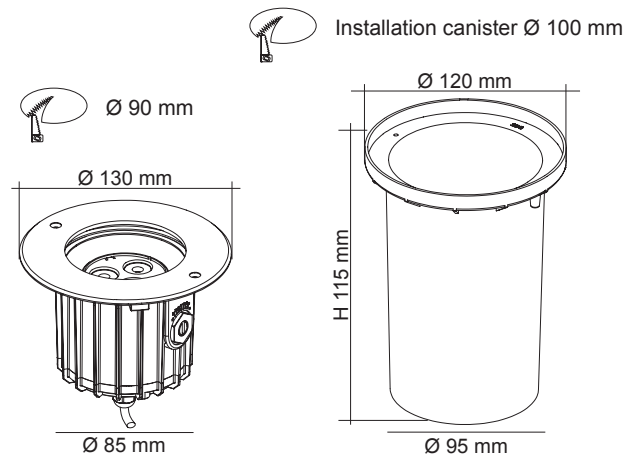

Model No.	Input	Power	Lumen	CCT	Beam Angle	CRI	Fitting Colour
S9338/3W/30 WW	24V	3W	150lm	3000K	30°	>70	Stainless Steel
S9338/3W/30 DL	24V	3W	200lm	6000K	30°	>70	Stainless Steel

### LIGHTING DIRECTION

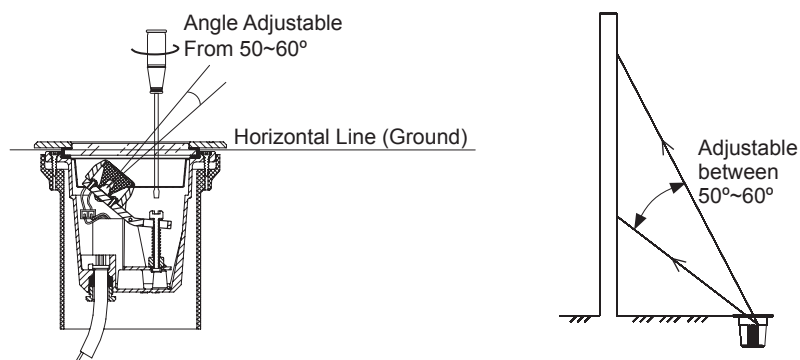



# LED INGROUND LIGHT

## S9341 GROUND MKII

**IP67**

### CONSTRUCTION

- 316L stainless steel face cover
- Die-cast aluminium body
- Clear tempered glass diffuser
- High efficiency SMD LED chips with optical lens
- Built-in constant current non-dimmable LED driver
- Silicon gasket
- IP68 PG9 PVC cable gland
- Stainless steel allen screws
- PVC installation canister included
- 450 mm 3 core rubber flex

### IP RATING

- IP67 weatherproof

### LOAD PRESSURE CAPACITY

- Maximum 2000 kg



### DIMENSIONS

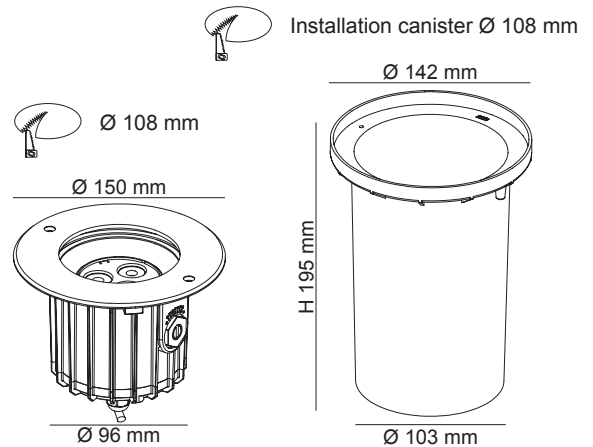
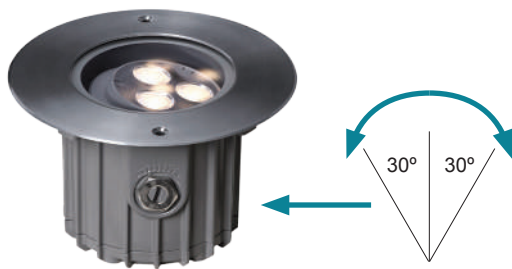

Model No.	Input	Power	Lumen	CCT	Beam Angle	CRI	Fitting Colour	Load Pressure Capacity
S9341WW	240V	8W	350lm	3000K	30°	>80	Stainless Steel	2000 kg
S9341CW	240V	8W	400lm	4000K	30°	>80	Stainless Steel	2000 kg





# LED INGROUND LIGHT

## S9342, S9343, S9344, S9345 GEO



### DIMENSIONS

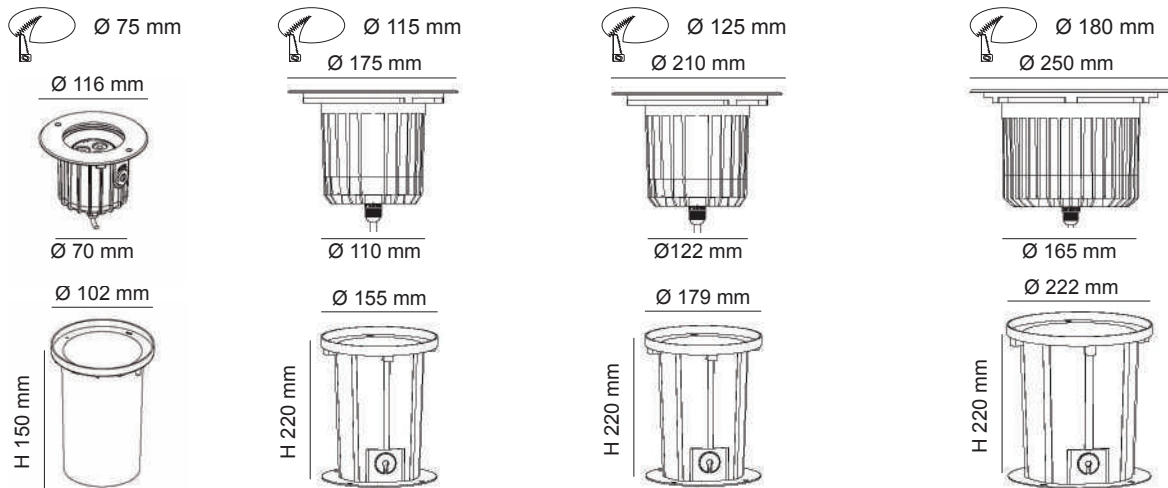

### CONSTRUCTION

- 316L stainless steel face cover
- Die-cast aluminium body
- Clear tempered glass diffuser
- High output COB LED chip
- High performance multi-reflector system
- Built-in constant current non-dimmable LED driver

- Silicon gasket
- IP68 PG11 PVC cable gland
- Stainless steel allen screws
- PVC installation canister included
- 450 mm 3 core rubber flex

### IP RATING

- IP67 weatherproof

Model No.	Input	Power	Lumen	CCT	Beam Angle	CRI	Fitting Colour	Load Pressure Capacity
S9342WW	240V	8W	400lm	3000K	24°	>80	Stainless Steel	3000 kg
S9342CW	240V	8W	450lm	4000K	24°	>80	Stainless Steel	3000 kg
S9343WW	240V	13W	600lm	3000K	24°	>80	Stainless Steel	4400 kg
S9343CW	240V	13W	700lm	4000K	24°	>80	Stainless Steel	4400 kg
S9344WW	240V	20W	1200lm	3000K	24°	>80	Stainless Steel	4900 kg
S9344CW	240V	20W	1400lm	4000K	24°	>80	Stainless Steel	4900 kg
S9345WW	240V	32W	2000lm	3000K	24°	>80	Stainless Steel	5000 kg
S9345CW	240V	32W	2200lm	4000K	24°	>80	Stainless Steel	5000 kg

# LED INGROUND LIGHT

## FOUR WAY **S9346, S9347** PATHWAY

## TWO WAY **S9348, S9349** PATHWAY



### DIMENSIONS

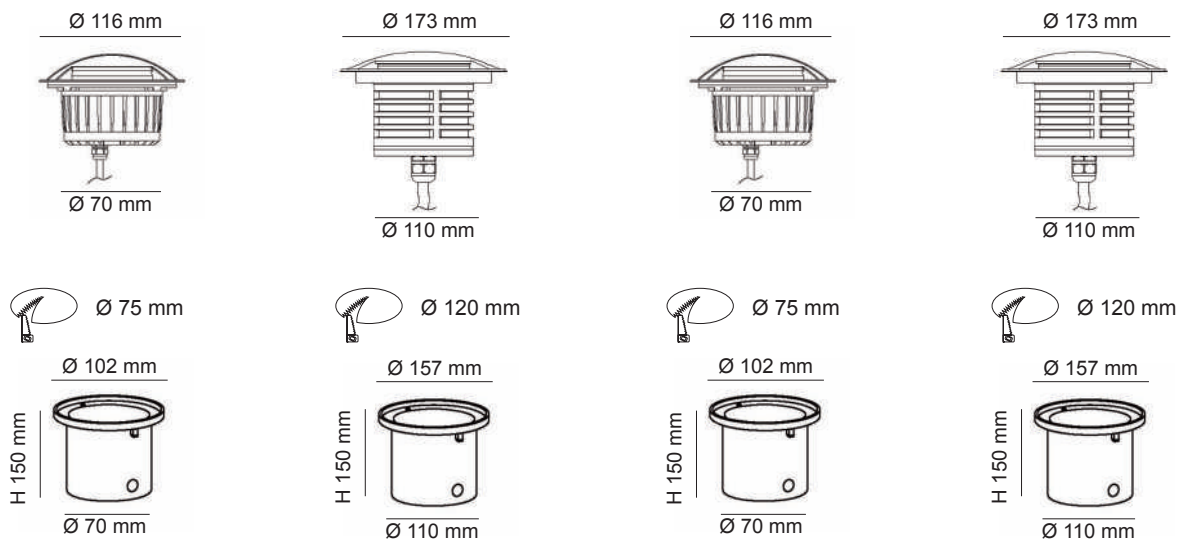

### CONSTRUCTION

- 316L stainless steel face cover
- Die-cast aluminium body
- Clear tempered glass diffuser
- High efficiency SMD LED chips with optical lens
- Built-in constant current non-dimmable LED driver
- Silicon gasket
- IP68 PG9 PVC cable gland
- Stainless steel allen screws
- PVC installation canister included
- 450 mm 3 core rubber flex

### IP RATING

- IP67 weatherproof

### LOAD PRESSURE CAPACITY

- Maximum 2000 kg

# LED INGROUND LIGHT

## ONE WAY S9351, S9352 PATHWAY

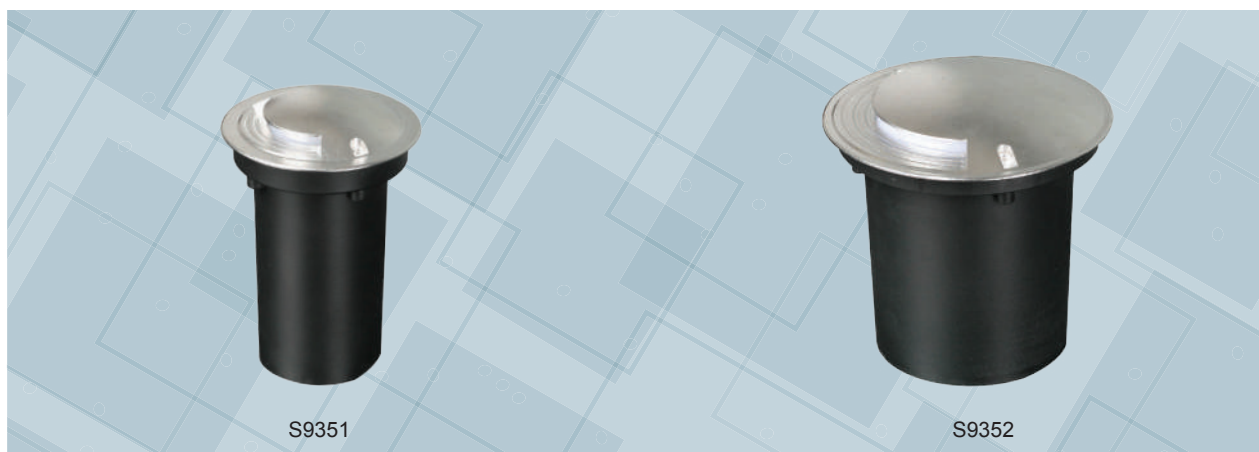

### DIMENSIONS

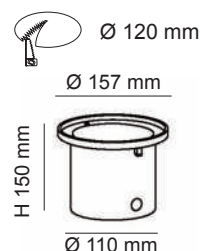
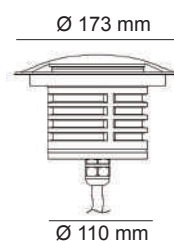
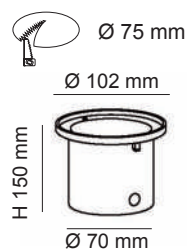
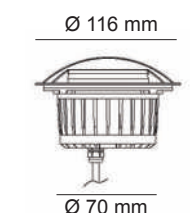

Model No.	Input	Power	Lumen	CCT	CRI	Fitting Colour	Load Pressure Capacity
S9346WW	240V	4W	160lm	3000K	>80	Stainless Steel	2000 kg
S9346CW	240V	4W	160lm	4000K	>80	Stainless Steel	2000 kg
S9347WW	240V	4W	160lm	3000K	>80	Stainless Steel	2000 kg
S9347CW	240V	4W	160lm	4000K	>80	Stainless Steel	2000 kg

Model No.	Input	Power	Lumen	CCT	CRI	Fitting Colour	Load Pressure Capacity
S9348WW	240V	4W	80lm	3000K	>80	Stainless Steel	2000 kg
S9348CW	240V	4W	80lm	4000K	>80	Stainless Steel	2000 kg
S9349WW	240V	4W	80lm	3000K	>80	Stainless Steel	2000 kg
S9349CW	240V	4W	80lm	4000K	>80	Stainless Steel	2000 kg

Model No.	Input	Power	Lumen	CCT	CRI	Fitting Colour	Load Pressure Capacity
S9351WW	240V	4W	40lm	3000K	>80	Stainless Steel	2000 kg
S9351CW	240V	4W	40lm	4000K	>80	Stainless Steel	2000 kg
S9352WW	240V	4W	40lm	3000K	>80	Stainless Steel	2000 kg
S9352CW	240V	4W	40lm	4000K	>80	Stainless Steel	2000 kg

# IP65 LED WEATHERPROOF BATTEN

## SL9721 KEW



### DIMENSIONS

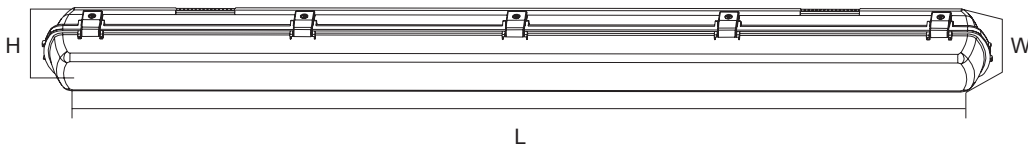

### CONSTRUCTION

- Rounded shape vandal proof design
- Polycarbonate body & diffuser
- Stainless steel clips & screws
- High efficiency SMD LED chips
- Constant current non-dimmable LED driver fitted
- Variable wattage DIP switch
- 100%, 75% or 50% setting available

### IP RATING

- IP65 weatherproof

### DIMMING OPTION

- Trailing edge dimming
- 1-10V dimming
- Digital dimming (DSI, DALI)

### SENSOR OPTIONS

- Integrated microwave motion sensor
- Integrated microwave motion sensor with standBY function



### EMERGENCY OPTIONS

- Compliant to AS2293
- Emergency classification:  
D32@C0, D20@C90 (SL 9721/35EM)  
D50@C0, D25@C90 (SL9721/20EM)



### ACCESSORIES INCLUDED

- Allen key & screws
- PVC cable glands
- Suspension brackets

### INSTALLATION TYPE

- Surface mounted
- Suspended (Suspension kit is required)

### SURFACE/SUSPENDED MOUNTING CLIPS TO MAINTAIN IP RATING

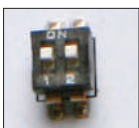

Variable wattage DIP switch



Stainless steel clips can be fastened with extra locking screws for security



Surface mounting bracket



Suspension bracket





Model No.	Input	Power	Lumen	CCT	Beam Angle	CRI	Dimensions L x W x H
SL9721/20W WW	240V	10/15/20W	900/1350/1800lm	3000K	100°	>80	610 x 115 x 75
SL9721/20W DL	240V	10/15/20W	900/1350/1800lm	5000K	100°	>80	610 x 115 x 75
SL9721/35W WW	240V	18/27/35W	1800/2700/3600lm	3000K	100°	>80	1210 x 115 x 75
SL9721/35W DL	240V	18/27/35W	1800/2700/3600lm	5000K	100°	>80	1210 x 115 x 75

## PHOTOMETRIC DATA

UNIT: cd C0/C180 — C60/240 — C90/270

SL9721/20W WW

SL9721/20W DL

SL9721/35W WW

SL9721/35W DL

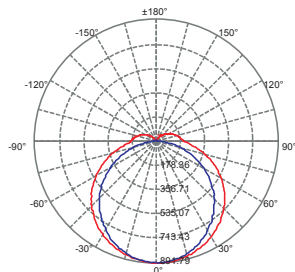
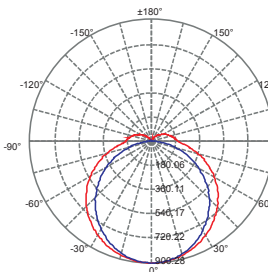
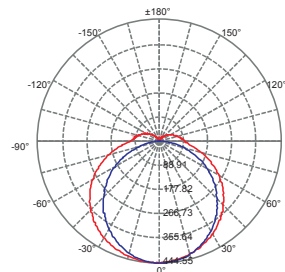
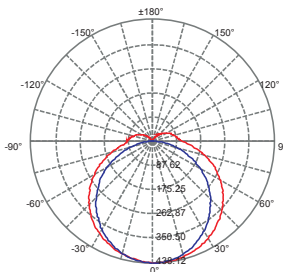

# LED WEATHERPROOF BATTEN

## SL9726 TC SOL



### DIMENSIONS

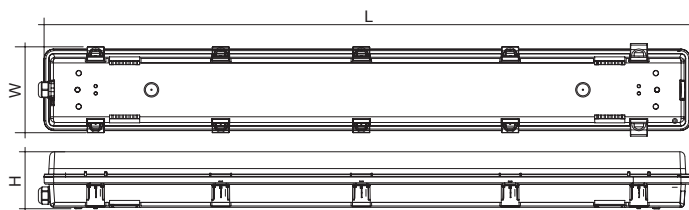

### CONSTRUCTION

- Colour temperature selectable by DIP switch
- Rounded shape vandal proof design
- Polycarbonate body & diffuser
- Stainless steel clips & screws
- High efficiency SMD LED chips
- Constant current non-dimmable LED driver fitted

### IP RATING

- IP65 weatherproof

### DIMMING OPTION

- Trailing edge dimming (SL9726/20TC only)
- 1-10V dimming
- Digital dimming (DSI, DALI)

### SENSOR OPTIONS

- Integrated microwave motion sensor
- Integrated microwave motion sensor with standBY function



### EMERGENCY OPTIONS

- Compliant to AS2293



### ACCESSORIES INCLUDED

- PVC cable glands
- Suspension brackets

### INSTALLATION TYPE

- Surface mounted
- Suspended (Suspension kit is required)

### SURFACE/SUSPENDED MOUNTING CLIPS TO MAINTAIN IP RATING



Surface mounting bracket



Suspension bracket

Model No.	Input	Power	Lumen	CCT	Beam Angle	CRI	Dimensions L x W x H
SL9726/20TC	240V	20W	1700lm/1800lm/1800lm	3000K/4000K/6000K	120°	>80	642 x 118 x 77
SL9726/40TC	240V	40W	3400lm/3600lm/3600lm	3000K/4000K/6000K	120°	>80	1251 x 118 x 77



# LED HIGH BAY

## SHB22, SHB22-D EAGLE



SHB22/140, SHB22/140D

SHB22/240, SHB22/240D

### DIMENSIONS

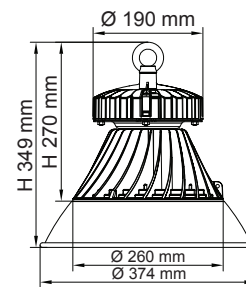
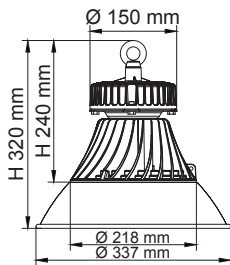

### CONSTRUCTION

- Die-cast aluminium body
- Powder coated finish
- High efficiency SMD LED chips
- Clear tempered glass diffuser
- Aluminium reflector
- Standard beam angle 90°

- Built-in constant current 1-10V dimmable LED driver (excluding **SHB22/140DL**, **SHB22/240DL**)
- IP66 PVC cable gland
- 1 m rubber flex & 3 pin plug fitted

### IP RATING

- IP65 weatherproof

Model No.	Input	Power	Lumen	CCT	Beam Angle	CRI	Colour	Dimmable	Net Weight
<b>SHB22/140DL</b>	240V	150W	15000lm	5000K	90°	>75	Black	No	5.8kg
<b>SHB22/140D/DL</b>	240V	150W	15000lm	5000K	90°	>75	Black	Yes*	5.8kg
<b>SHB22/240DL</b>	240V	240W	26000lm	5000K	90°	>75	Black	No	6.6kg
<b>SHB22/240D/DL</b>	240V	240W	26000lm	5000K	90°	>75	Black	Yes*	6.6kg

\*1-10V dimming

### PHOTOMETRIC DATA

Unit: cd C0/C180 — C90/C270 —

SHB22/140DL

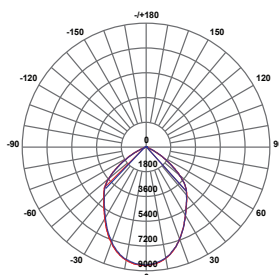

SHB22/240DL

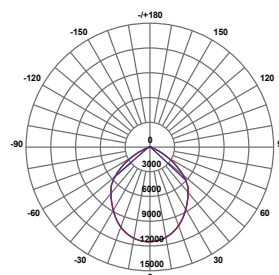

# LED UFO LIGHT

## SHB23, SLB23, SFD23 UFO



SHB23 High Bay

### DIMENSIONS

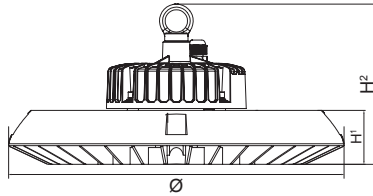

### CONSTRUCTION

- Die-cast aluminium body
- Powder coated finish
- High efficiency SMD LED chips
- Clear tempered glass diffuser
- Built-in constant current 1-10V dimmable LED driver
- IP66 PVC cable gland
- 2 m rubber flex & 3 pin plug fitted

### IP RATING

- IP65 weatherproof

### BEAM ANGLE

- 120° lens (standard)
- **SHB23/150D**: 45° or 90° lens (option)
- **SHB23/230D**: 60° or 90° lens (option)

### ACCESSORY OPTIONS

- **SHB23/150PCP, SHB23/230PCP**  
Clear polycarbonate diffuser
- **SHB23/150PFP, SHB23/230PFP**  
Frost polycarbonate diffuser
- **SHB23/150PPR**  
Prismatic reflector
- **SHB23/150PMR, SHB23/230PMR**  
Aluminium reflector
- **SHB23/150PWG, SHB23/230PWG**  
Wire guard

All model numbers in the following table include an appropriate mounting ring or bracket.

Model No.	Input	Power	Lumen	CCT	Beam Angle	CRI	Colour	Dimensions Ø x H1 x H2	Net Weight
<b>SHB23/150D</b>	240V	150W	18000lm	5700K	120°	>80	Black	330 mm x 53 x 175 mm	4.9 kg
<b>SLB23/150D</b>	240V	150W	18000lm	5700K	120°	>80	Black	330 mm x 53 x 146 mm	4.9 kg
<b>SFD23/150D</b>	240V	150W	18000lm	5700K	120°	>80	Black	330 mm x 53 x 228 mm	4.9 kg
<b>SHB23/230D</b>	240V	230W	28000lm	5700K	120°	>80	Black	400 mm x 60 x 195 mm	7.4 kg
<b>SLB23/230D</b>	240V	230W	28000lm	5700K	120°	>80	Black	400 mm x 60 x 181 mm	7.4 kg
<b>SFD23/230D</b>	240V	230W	28000lm	5700K	120°	>80	Black	400 mm x 60 x 270mm	7.4 kg

Please Note: The following brackets are only required when converting a High Bay to a Low Bay or a Flood Light.

#### BRACKETS (SHB23/150)

- SHB23/150PFD** To convert SHB23/150 High Bay to SFD23/150 Flood Light  
**SHB23/150PLB** To convert SHB23/150 High Bay to SLB23/150 Low Bay

#### BRACKETS (SHB23/230)

- SHB23/230PFD** To convert SHB23/230 High Bay to SFD23/230 Flood Light  
**SHB23/230PLB** To convert SHB23/230 High Bay to SLB23/230 Low Bay



www.sal.net.au

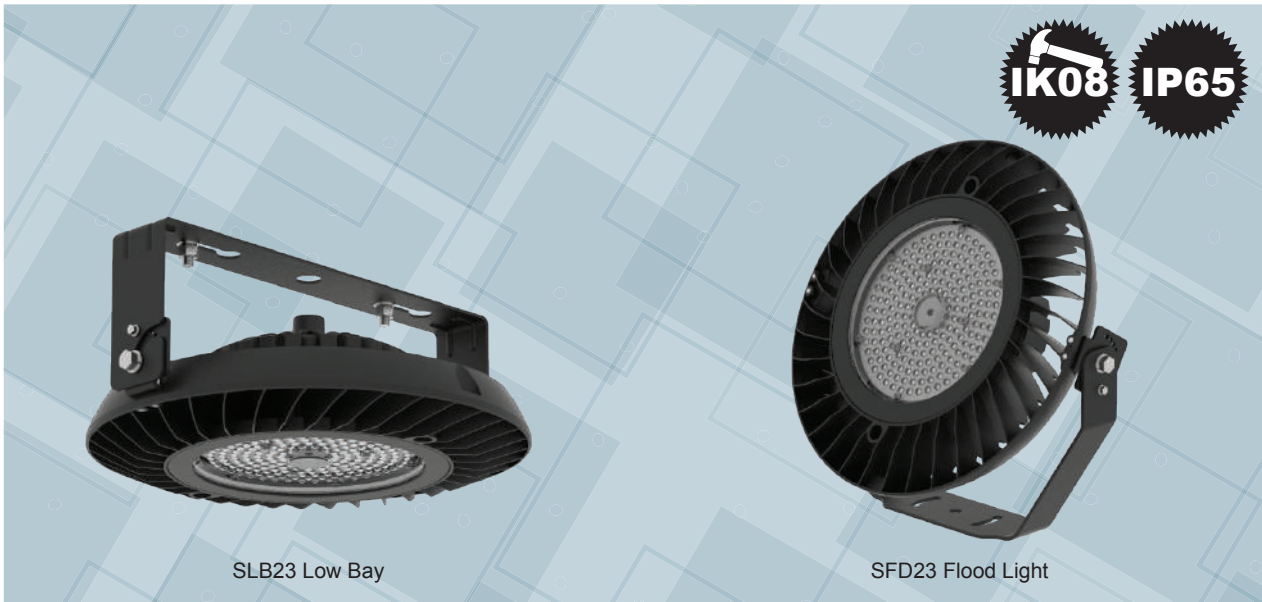

SLB23 Low Bay

SFD23 Flood Light

## DIMENSIONS

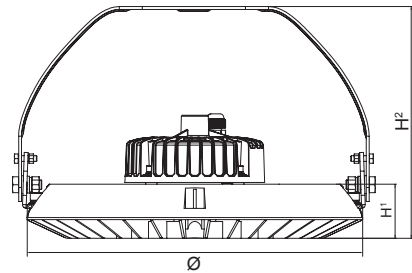
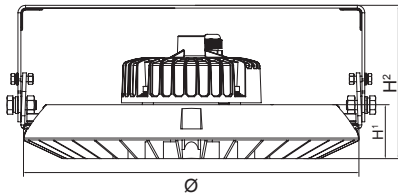

## ACCESSORIES



Lens for Beam angle options



Bracket for Flood Light  
SHB23/150PFD, SHB23/230PFD



Bracket for Low Bay  
SHB23/150PLB, SHB23/230PLB



Clear polycarbonate diffuser  
SHB23/150PCP, SHB23/230PCP



Frost polycarbonate diffuser  
SHB23/150PFP, SHB23/230PFP



Metal reflector  
SHB23/150PMR, SHB23/230PMR

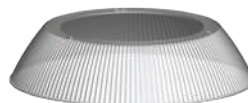

Prismatic reflector  
SHB23/150PPR



Wire guard  
SHB23/150PWG, SHB23/230PWG

## PHOTOMETRIC DATA

Unit: cd C0/C180 — C90/C270 —

SHB23/150D, SLB23/150D, SFD23/150D

SHB23/230D, SLB23/230D, SFD23/230D

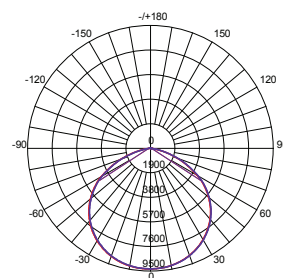
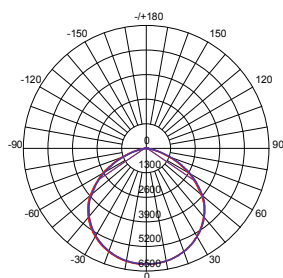

www.sal.net.au

# LED CANOPY LIGHT

## SHP205 CANOPY

**IP66**



### DIMENSIONS

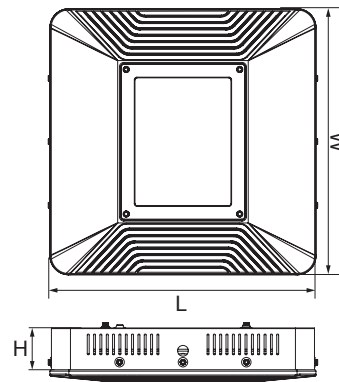
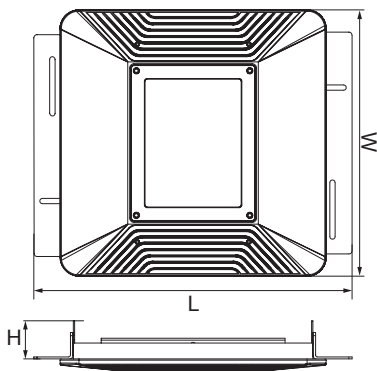

### CONSTRUCTION

- Die-cast aluminium body
- Powder coated finish
- Clear tempered glass diffuser
- High efficiency SMD LED chips
- Built-in constant current non-dimmable LED driver
- High efficiency heat dissipation, light weight heatsink
- 120° beam angle

- Suits most traditional Canopy size (SHP205 RC)
- Symmetrical light distribution
- 300 mm 3 core rubber flex

### IP RATING

- IP66 weatherproof

### FITTING COLOUR

- White

Model No.	Input	Power	Lumen	CCT	Beam Angle	CRI	Cut Out	Dimensions L x W x H	Net Weight
<b>SHP205/75RCS</b>	240V	75W	9750lm	5000K	120°	>75	380 x 380 mm	502 x 420 x 60	7.5 kg
<b>SHP205/75SM</b>	240V	75W	9750lm	5000K	120°	>75	–	420 x 420 x 66	7.5 kg
<b>SHP205/110RCS</b>	240V	110W	14300lm	5000K	120°	>75	380 x 380 mm	502 x 420 x 60	7.5 kg
<b>SHP205/110SM</b>	240V	110W	14300lm	5000K	120°	>75	–	420 x 420 x 66	7.5 kg
<b>SHP205/150RCS</b>	240V	150W	19500lm	5000K	120°	>75	380 x 380 mm	502 x 420 x 60	7.5 kg
<b>SHP205/150SM</b>	240V	150W	19500lm	5000K	120°	>75	–	420 x 420 x 66	7.5 kg

**IP66**

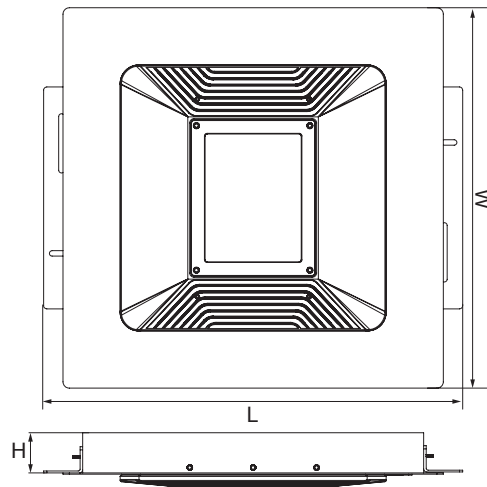

Model No.	Input	Power	Lumen	CCT	Beam Angle	CRI	Cut Out	Dimensions L x W x H	Net Weight
<b>SHP205/75RC</b>	240V	75W	9750lm	5000K	120°	>75	422 x 540 mm	600 x 600 x 66	12 kg
<b>SHP205/110RC</b>	240V	110W	14300lm	5000K	120°	>75	422 x 540 mm	600 x 600 x 66	12 kg
<b>SHP205/150RC</b>	240V	150W	19500lm	5000K	120°	>75	422 x 540 mm	600 x 600 x 66	12 kg

**PHOTOMETRIC DATA** Unit: cd C0/C180 — C90/C270 —

SHP205/75

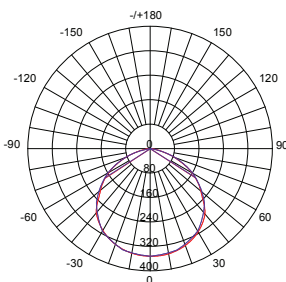

SHP205/110

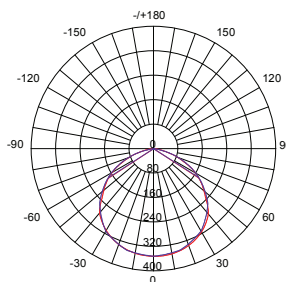

SHP205/150

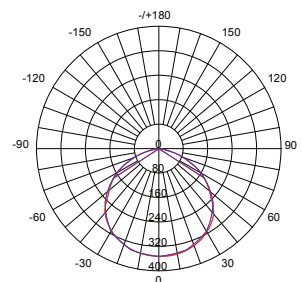



# LED AREA LIGHT

## SHP200/120, SHP200/240 PARK



### DIMENSIONS

SHP200/120

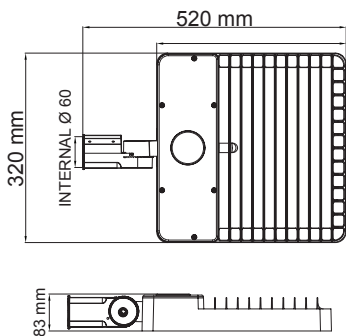

SHP200/240

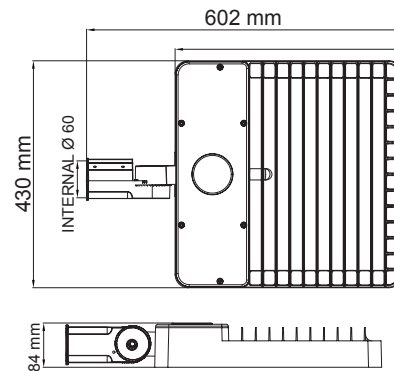

### CONSTRUCTION

- Die-cast aluminium body
- Powder coated finish
- Clear tempered glass diffuser
- High efficiency SMD LED chips
- Built-in constant current non-dimmable LED driver
- High efficiency heat dissipation, light weight heatsink
- Pole mounting angle adjustable from 0° to 90°
- Symmetric light distribution (TYPE V) fitted
- Asymmetric light distribution (TYPE III) option

- Ø 60 mm pole mounting bracket
- 450 mm 3 core rubber flex

### IP RATING

- IP65 weatherproof

### COLOUR TEMPERATURE

- 5000K Neutral Daylight (standard)
- 3000K Warm White (option)
- 4000K Cool White (option)

Model No.	Input	Power	Lumen	CCT	CRI	Fitting Colour	Net Weight
SHP200/120NDL/CB	240V	120W	12000lm	5000K	>75	Charcoal Black	6.8 kg
SHP200/120NDL/BK	240V	120W	12000lm	5000K	>75	Black	6.8 kg
SHP200/240NDL/CB	240V	240W	24000lm	5000K	>75	Charcoal Black	10.5 kg
SHP200/240NDL/BK	240V	240W	24000lm	5000K	>75	Black	10.5 kg







## STANDARD INSTALLATION

- STANDARD pole diameter: Ø 60 mm

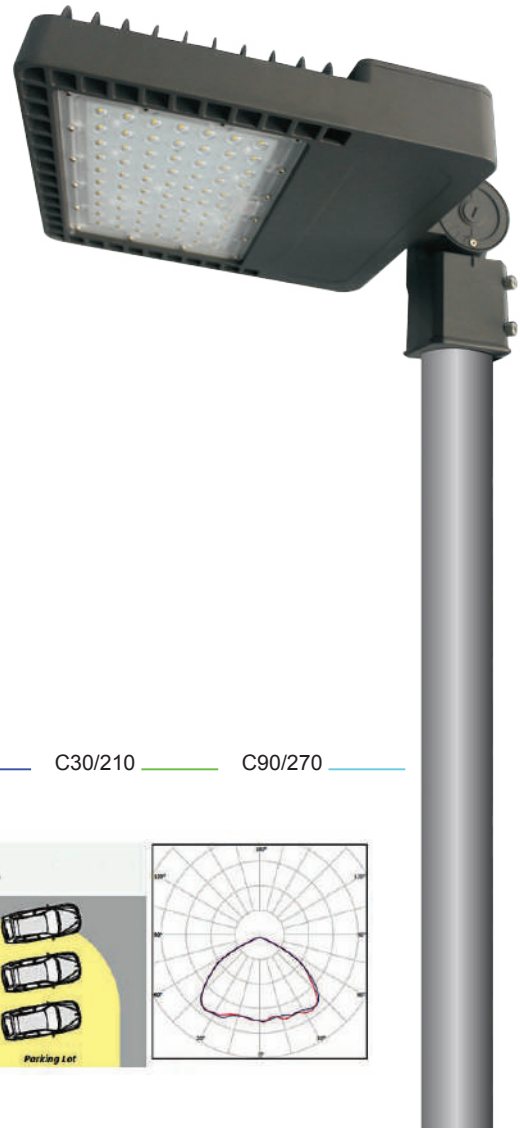
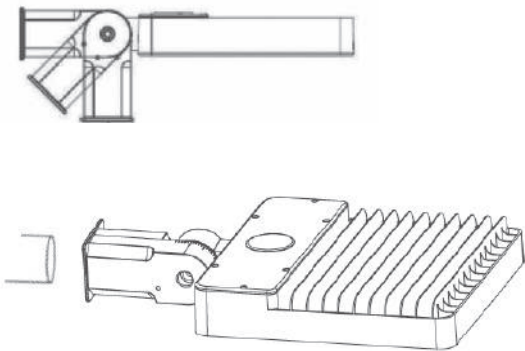

**PHOTOMETRIC DATA** UNIT: cd C0/C180 — C60/240 — C30/210 — C90/270 —

TYPE III

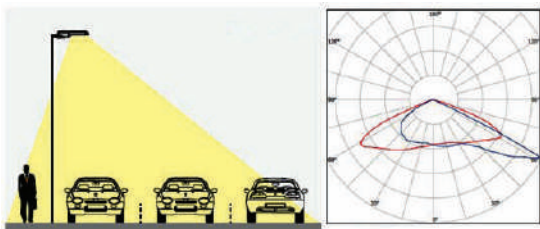

TYPE V

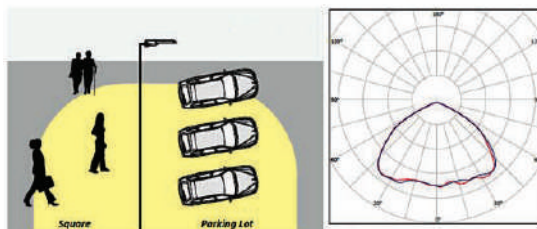

# LED AREA LIGHT

## SE7100/600, SE7100/900 POWERSTAR



### DIMENSIONS

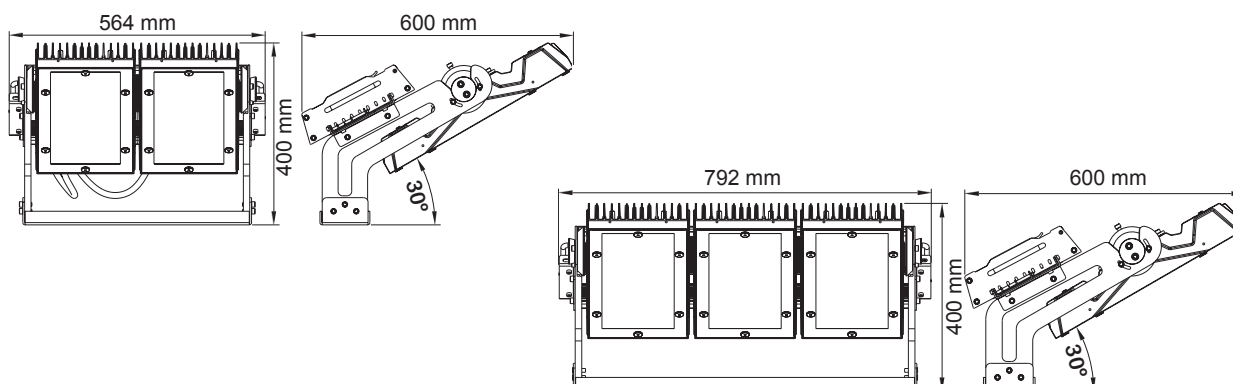

### CONSTRUCTION

- Die-cast aluminium body
- Powder coated finish
- Clear tempered glass diffuser
- Built-in surge protection device (10KV) for extra safety operation
- High efficiency SMD LED chips
- Built-in constant current non-dimmable LED driver
- High efficiency heat dissipation, light weight heatsink
- 40° module frame adjustable
- 70° individual module adjustable
- 1.1 m 3 core rubber flex

### IP RATING

- IP66 weatherproof

### FITTING COLOUR

- Black

### COLOUR TEMPERATURE

- 5000K Neutral Daylight (standard)
- 3000K Warm White (option)
- 4000K Cool White (option)

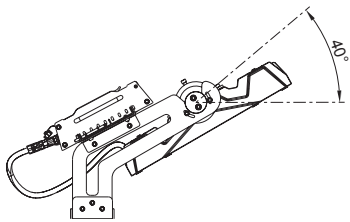
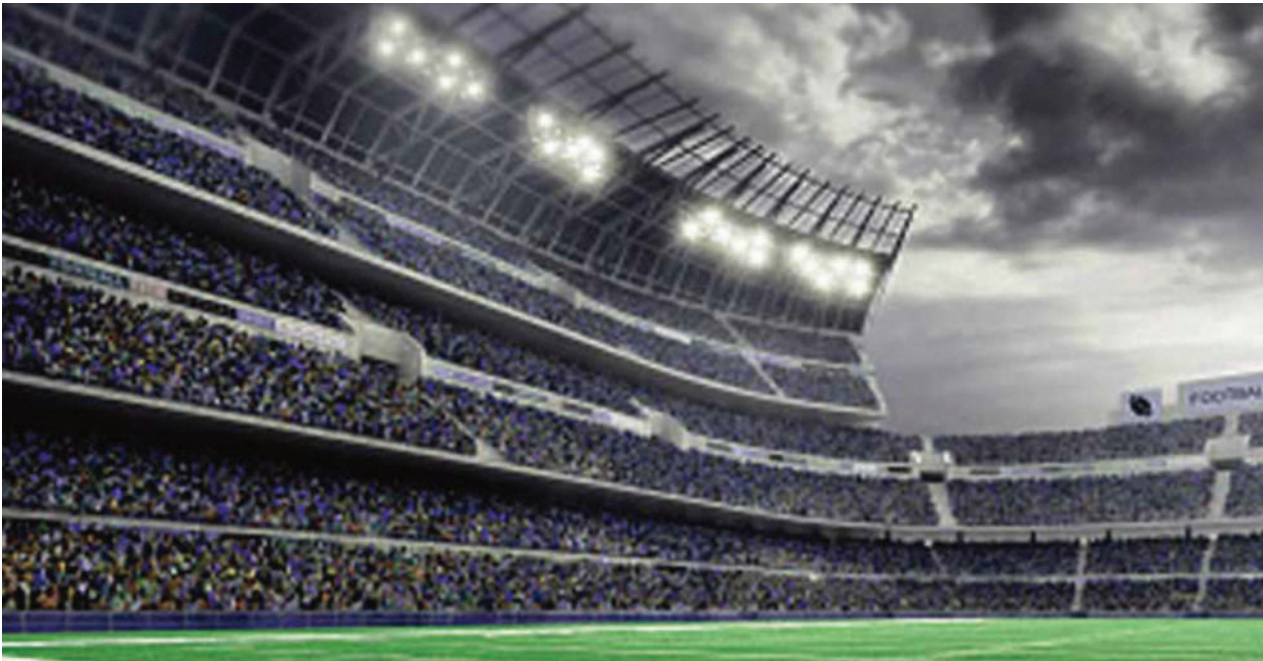

Module frame

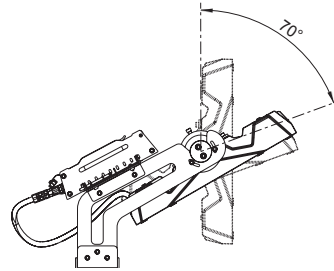

Individual module

Model No.	Input	Power	Lumen	CCT	Beam Angle	Beam Type	CRI	Net Weight
SE7100/6018	240V	600W	66,000lm	5000K	18°	Symmetrical	>80	28 kg
SE7100/6030	240V	600W	66,000lm	5000K	30°	Symmetrical	>80	28 kg
SE7100/6055	240V	600W	66,000lm	5000K	55°	Asymmetrical	>80	28 kg
SE7100/6155	240V	600W	66,000lm	5000K	155°	Asymmetrical	>80	28 kg
SE7100/9018	240V	900W	99,000lm	5000K	18°	Symmetrical	>80	40 kg
SE7100/9030	240V	900W	99,000lm	5000K	30°	Symmetrical	>80	40 kg
SE7100/9055	240V	900W	99,000lm	5000K	55°	Asymmetrical	>80	40 kg
SE7100/9155	240V	900W	99,000lm	5000K	155°	Asymmetrical	>80	40 kg

**PHOTOMETRIC DATA** UNIT: CD; C0/C180 ——— C90/C270 ———

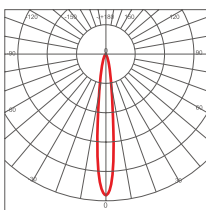

SE7100/6018  
SE7100/9018

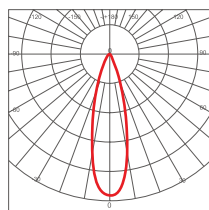

SE7100/6030  
SE7100/9030

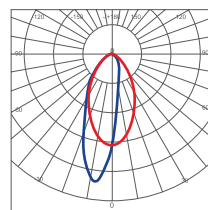

SE7100/6055  
SE7100/9055

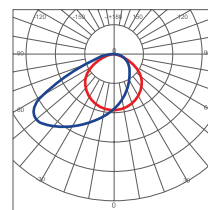

SE7100/6155  
SE7100/9155



# LED STREET LIGHT

## SHP305, SHP306 DRIVE



### DIMENSIONS

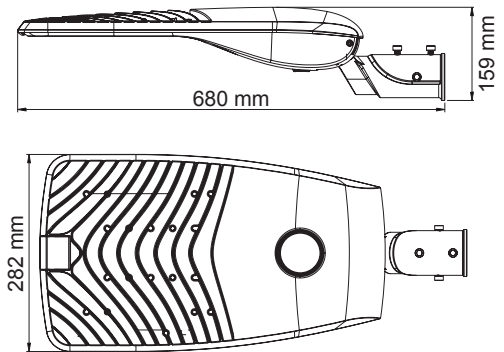
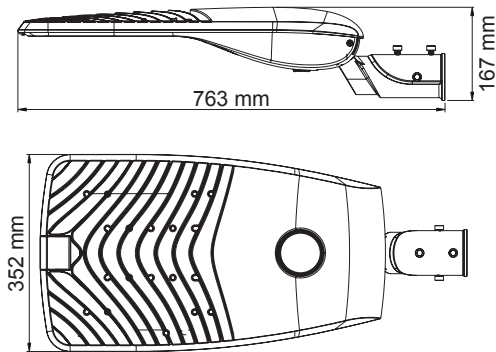

### CONSTRUCTION

- Die-cast aluminium body
- Powder coated finish
- Clear tempered glass diffuser
- Built-in surge protection device (10KV) for extra safety operation
- High efficiency SMD LED chips
- Built-in 3-in-1 dimming function LED driver fitted (1-10VDC, PWM signal & resistance)
- High efficiency heat dissipation, light weight heatsink
- Asymmetrical light distribution (TYPE II) fitted
- 0% upward light ratio
- Standard 3G.ANSI C.136.31-2010 Ø 60 pole mounting bracket
- 800 mm 3 core rubber flex

### IP RATING

- IP66 weatherproof

### COLOUR TEMPERATURE

- 4000K Cool White (standard)
- 3000K Warm White (option)
- 6000K Daylight (option)

### DIMMING OPTIONS

- SMART timer dimming

### LENS OPTIONS (Refer to Photometric data below)

- SHP305A75/P (standard)
- SHP305A45/P (option)
- SHP306A45/P (standard)
- SHP306A75/P (option)

### ACCESSORIES OPTION

- Photocell sensor

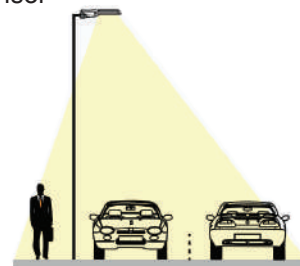

TYPE II



Model No.	Input	Power	Lumen	CCT	CRI	Fitting Colour	Net Weight
SHP305/70CW/BK	240V	70W	120lm/W	4000K	>70	Black	9.2 kg
SHP305/90CW/BK	240V	90W	120lm/W	4000K	>70	Black	9.2 kg
SHP305/120CW/BK	240V	120W	120lm/W	4000K	>70	Black	9.2 kg
SHP305/150CW/BK	240V	150W	120lm/W	4000K	>70	Black	9.2 kg
SHP305/180CW/BK	240V	180W	120lm/W	4000K	>70	Black	9.2 kg
SHP306/30CW/BK	240V	30W	120lm/W	4000K	>70	Black	6.8 kg
SHP306/50CW/BK	240V	50W	120lm/W	4000K	>70	Black	6.8 kg
SHP306/70CW/BK	240V	70W	120lm/W	4000K	>70	Black	6.8 kg
SHP306/90CW/BK	240V	90W	120lm/W	4000K	>70	Black	6.8 kg

**PHOTOMETRIC DATA** UNIT: cd, C0/C180 — C90/270

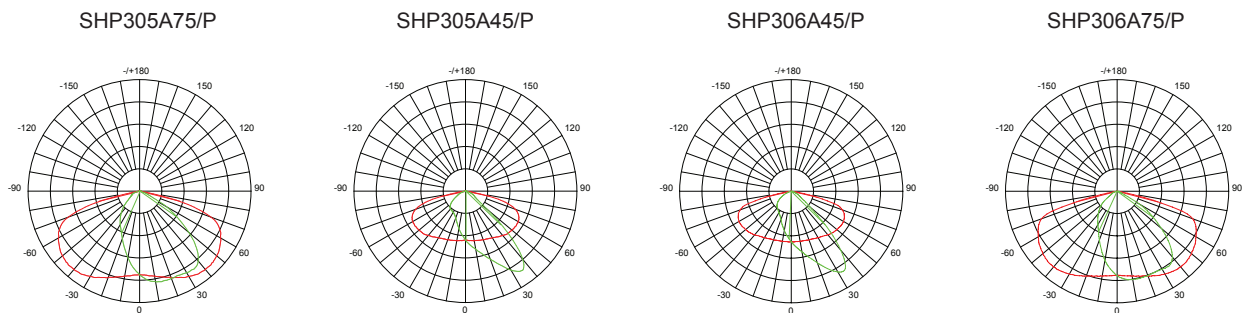



[www.sal.net.au](http://www.sal.net.au)

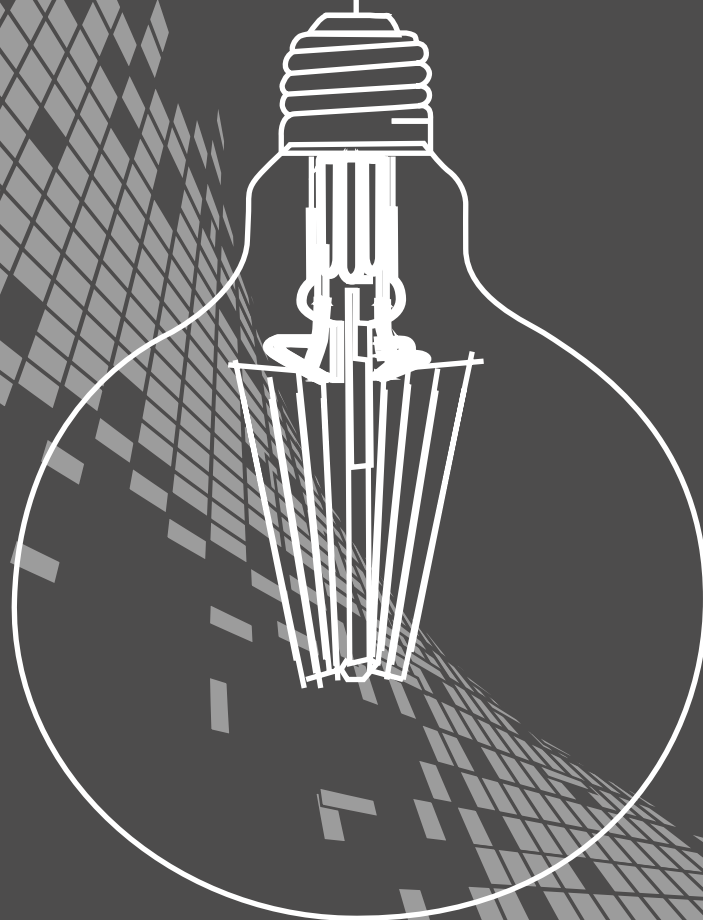



# LED LAMPS, DRIVERS & ACCESSORIES

## NEW PRODUCTS



p258  
LG5, LG9 CLEAR



p259  
LG5, LG9 OPAL



p260  
LCA CLEAR



p261  
LCA OPAL



p262  
LFR CLEAR



p263  
LFR OPAL



p281  
LCT21TC, LCT30TC



p291  
SHL008



p300  
SMS731 SENSOR

# LED FILAMENT GLS STYLE LAMP

## LG5, LG9 CLEAR



### DIMENSIONS

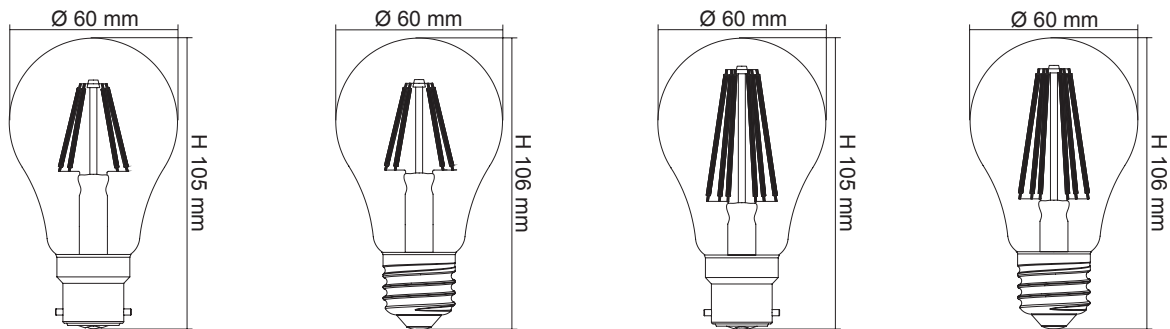

### CONSTRUCTION

- Clear glass diffuser
- High efficiency LED filament
- High colour rendering
- Built-in trailing edge dimmable LED driver
- 360° beam angle
- Double insulation

### COLOUR TEMPERATURE

- 2700K Warm White
- 5000K Neutral Daylight

### LAMP BASE

- B22
- E27

### FEATURES

- 1:1 size to traditional GLS lamp
- Dimmable
- Suits most GLS lamp fittings

Model No.	Input	Power	Lumen	CCT	Beam Angle	CRI	Dimmable	Lamp Base	Approximately equivalent to incandescent
LG5/27B22D/C	240V	4W	500lm	2700K	360°	>80	Yes*	B22	
LG5/27E27D/C	240V	4W	500lm	2700K	360°	>80	Yes*	E27	
LG5/50B22D/C	240V	4W	550lm	5000K	360°	>80	Yes*	B22	
LG5/50E27D/C	240V	4W	550lm	5000K	360°	>80	Yes*	E27	
LG9/27B22D/C	240V	8W	950lm	2700K	360°	>80	Yes*	B22	
LG9/27E27D/C	240V	8W	950lm	2700K	360°	>80	Yes*	E27	
LG9/50B22D/C	240V	8W	1000lm	5000K	360°	>80	Yes*	B22	
LG9/50E27D/C	240V	8W	1000lm	5000K	360°	>80	Yes*	E27	

\*Trailing edge dimming

# LED FILAMENT GLS STYLE LAMP

## LG5, LG9 OPAL



LG5 B22, LG9 B22

LG5 E27, LG9 E27

### DIMENSIONS

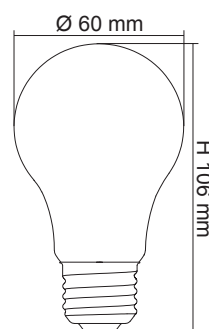
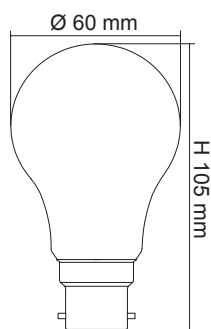

### CONSTRUCTION

- Opal glass diffuser
- High efficiency LED filament
- High colour rendering
- Built-in trailing edge dimmable LED driver
- 360° beam angle
- Double insulation

### COLOUR TEMPERATURE

- 2700K Warm White
- 5000K Neutral Daylight

### LAMP BASE

- B22
- E27

### FEATURES

- 1:1 size to traditional GLS lamp
- Dimmable
- Suits most GLS lamp fittings

Model No.	Input	Power	Lumen	CCT	Beam Angle	CRI	Dimmable	Lamp Base	Approximately equivalent to incandescent
LG5/27B22D	240V	4W	450lm	2700K	360°	>80	Yes*	B22	
LG5/27E27D	240V	4W	450lm	2700K	360°	>80	Yes*	E27	
LG5/50B22D	240V	4W	500lm	5000K	360°	>80	Yes*	B22	
LG5/50E27D	240V	4W	500lm	5000K	360°	>80	Yes*	E27	
LG9/27B22D	240V	8W	900lm	2700K	360°	>80	Yes*	B22	
LG9/27E27D	240V	8W	900lm	2700K	360°	>80	Yes*	E27	
LG9/50B22D	240V	8W	950lm	5000K	360°	>80	Yes*	B22	
LG9/50E27D	240V	8W	950lm	5000K	360°	>80	Yes*	E27	

\*Trailing edge dimming



# LED FILAMENT CANDLE LAMP

## LCA CLEAR



### DIMENSIONS

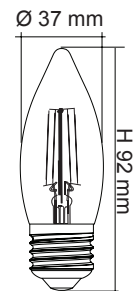
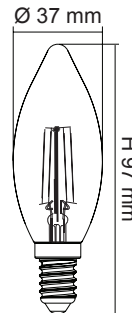
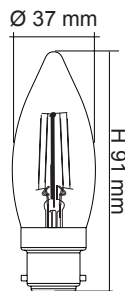
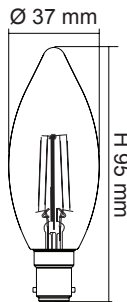

### CONSTRUCTION

- Clear glass diffuser
- High efficiency LED filament
- High colour rendering
- Built-in trailing edge dimmable LED driver
- 360° beam angle
- Double insulation

### COLOUR TEMPERATURE

- 2700K Warm White
- 5000K Neutral Daylight

### LAMP BASE

- B15
- B22
- E14
- E27

### FEATURES

- 1:1 size to traditional candle lamp
- Dimmable
- Suits most candle lamp fittings

Model No.	Input	Power	Lumen	CCT	Beam Angle	CRI	Dimmable	Lamp Base	Approximately equivalent to incandescent
LCA27B15D/C	240V	4W	450lm	2700K	360°	>80	Yes*	B15	
LCA27B22D/C	240V	4W	450lm	2700K	360°	>80	Yes*	B22	
LCA27E14D/C	240V	4W	450lm	2700K	360°	>80	Yes*	E14	
LCA27E27D/C	240V	4W	450lm	2700K	360°	>80	Yes*	E27	
LCA50B15D/C	240V	4W	450lm	5000K	360°	>80	Yes*	B15	
LCA50B22D/C	240V	4W	450lm	5000K	360°	>80	Yes*	B22	
LCA50E14D/C	240V	4W	450lm	5000K	360°	>80	Yes*	E14	
LCA50E27D/C	240V	4W	450lm	5000K	360°	>80	Yes*	E27	



\*Trailing edge dimming



# LED FILAMENT CANDLE LAMP

## LCA OPAL



### DIMENSIONS

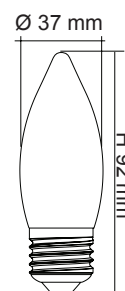
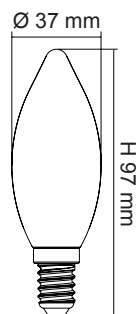
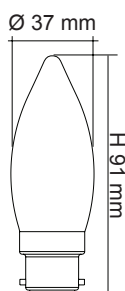
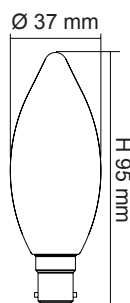

### CONSTRUCTION

- Opal glass diffuser
- High efficiency LED filament
- High colour rendering
- Built-in trailing edge dimmable LED driver
- 360° beam angle
- Double insulation

### COLOUR TEMPERATURE

- 2700K Warm White
- 5000K Neutral Daylight

### LAMP BASE

- B15
- B22
- E14
- E27

### FEATURES

- 1:1 size to traditional candle lamp
- Dimmable
- Suits most candle lamp fittings

Model No.	Input	Power	Lumen	CCT	Beam Angle	CRI	Dimmable	Lamp Base	Approximately equivalent to incandescent
LCA27B15D	240V	4W	400lm	2700K	360°	>80	Yes*	B15	
LCA27B22D	240V	4W	400lm	2700K	360°	>80	Yes*	B22	
LCA27E14D	240V	4W	400lm	2700K	360°	>80	Yes*	E14	
LCA27E27D	240V	4W	400lm	2700K	360°	>80	Yes*	E27	
LCA50B15D	240V	4W	400lm	5000K	360°	>80	Yes*	B15	
LCA50B22D	240V	4W	400lm	5000K	360°	>80	Yes*	B22	
LCA50E14D	240V	4W	400lm	5000K	360°	>80	Yes*	E14	
LCA50E27D	240V	4W	400lm	5000K	360°	>80	Yes*	E27	



\*Trailing edge dimming



# LED FILAMENT FANCY ROUND LAMP

## LFR CLEAR



### DIMENSIONS

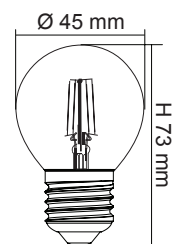
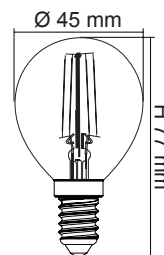
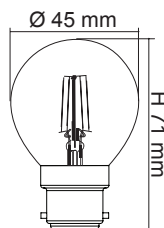
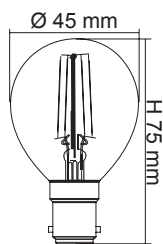

### CONSTRUCTION

- Clear glass diffuser
- High efficiency LED filament
- High colour rendering
- Built-in trailing edge dimmable LED driver
- 360° beam angle
- Double insulation

### COLOUR TEMPERATURE

- 2700K Warm White
- 5000K Neutral Daylight

### LAMP BASE

- B15
- B22
- E14
- E27

### FEATURES

- 1:1 size to traditional fancy round lamp
- Dimmable
- Suits most fancy round lamp fittings

Model No.	Input	Power	Lumen	CCT	Beam Angle	CRI	Dimmable	Lamp Base	Approximately equivalent to incandescent
LFR27B15D/C	240V	4W	450lm	2700K	360°	>80	Yes*	B15	
LFR27B22D/C	240V	4W	450lm	2700K	360°	>80	Yes*	B22	
LFR27E14D/C	240V	4W	450lm	2700K	360°	>80	Yes*	E14	
LFR27E27D/C	240V	4W	450lm	2700K	360°	>80	Yes*	E27	
LFR50B15D/C	240V	4W	450lm	5000K	360°	>80	Yes*	B15	
LFR50B22D/C	240V	4W	450lm	5000K	360°	>80	Yes*	B22	
LFR50E14D/C	240V	4W	450lm	5000K	360°	>80	Yes*	E14	
LFR50E27D/C	240V	4W	450lm	5000K	360°	>80	Yes*	E27	



\*Trailing edge dimming



# LED FILAMENT FANCY ROUND LAMP

## LFR OPAL



### DIMENSIONS

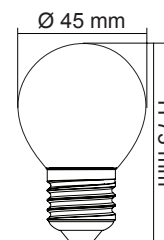
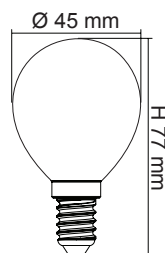
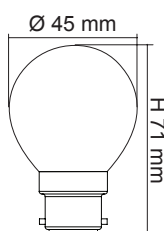
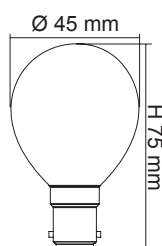

### CONSTRUCTION

- Opal glass diffuser
- High efficiency LED filament
- High colour rendering
- Built-in trailing edge dimmable LED driver
- 360° beam angle
- Double insulation

### FEATURES

- 1:1 size to traditional fancy round lamp
- Dimmable
- Suits most fancy round lamp fittings

### COLOUR TEMPERATURE

- 2700K Warm White
- 5000K Neutral Daylight

### LAMP BASE

- B15
- B22
- E14
- E27

Model No.	Input	Power	Lumen	CCT	Beam Angle	CRI	Dimmable	Lamp Base	Approximately equivalent to incandescent
LFR27B15D	240V	4W	400lm	2700K	360°	>80	Yes*	B15	
LFR27B22D	240V	4W	400lm	2700K	360°	>80	Yes*	B22	
LFR27E14D	240V	4W	400lm	2700K	360°	>80	Yes*	E14	
LFR27E27D	240V	4W	400lm	2700K	360°	>80	Yes*	E27	
LFR50B15D	240V	4W	400lm	5000K	360°	>80	Yes*	B15	
LFR50B22D	240V	4W	400lm	5000K	360°	>80	Yes*	B22	
LFR50E14D	240V	4W	400lm	5000K	360°	>80	Yes*	E14	
LFR50E27D	240V	4W	400lm	5000K	360°	>80	Yes*	E27	



\*Trailing edge dimming



# LED FILAMENT TUBULAR LAMP

## LT25 CLEAR

# LED FILAMENT PILOT LAMP

## LP25 CLEAR



### DIMENSIONS

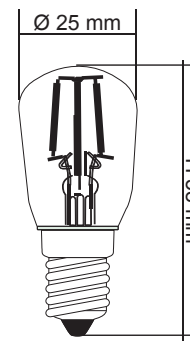
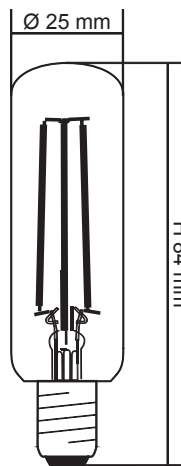

### CONSTRUCTION

- Clear glass diffuser
- High efficiency LED filament
- High colour rendering
- Built-in non-dimmable LED driver
- 360° beam angle
- Double insulation

### FEATURE

- Suitable to replace equivalent incandescent tubular lamp or pilot lamp

### COLOUR TEMPERATURE

- 3000K Warm White

### LAMP BASE

- E14

Model No.	Input	Power	Lumen	Beam Angle	CCT	CRI	Dimmable	Lamp Base
LT25F830E14	240V	2W	200lm	360°	3000K	>80	No	E14
LP25F830E14	240V	1.5W	150lm	360°	3000K	>80	No	E14

# LED FILAMENT VINTAGE DECO LAMP

## LST21FD

# LED FILAMENT SPHERICAL DECO LAMP

## LG125FD



## DIMENSIONS

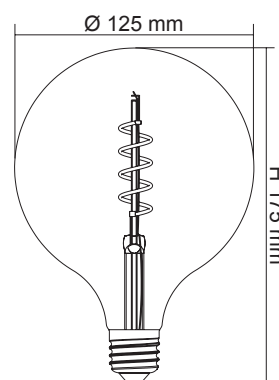
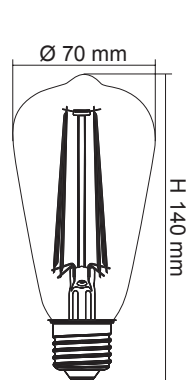

## CONSTRUCTION

- Champagne coloured glass diffuser for decorative applications
- High efficiency LED filament
- Built-in non-dimmable LED driver
- 360° beam angle
- Double insulation 

## COLOUR TEMPERATURE

- 2200K Warm White

## LAMP BASE

- E27

Model No.	Input	Power	Lumen	Beam Angle	CCT	CRI	Dimmable	Lamp Base
LST21FD822E27	240V	1W	100lm	360°	2200K	>80	No	E27
LG125FD822E27	240V	1W	100lm	360°	2200K	>80	No	E27

# LED FILAMENT SPHERICAL LAMP

## LG95, LG125



### DIMENSIONS

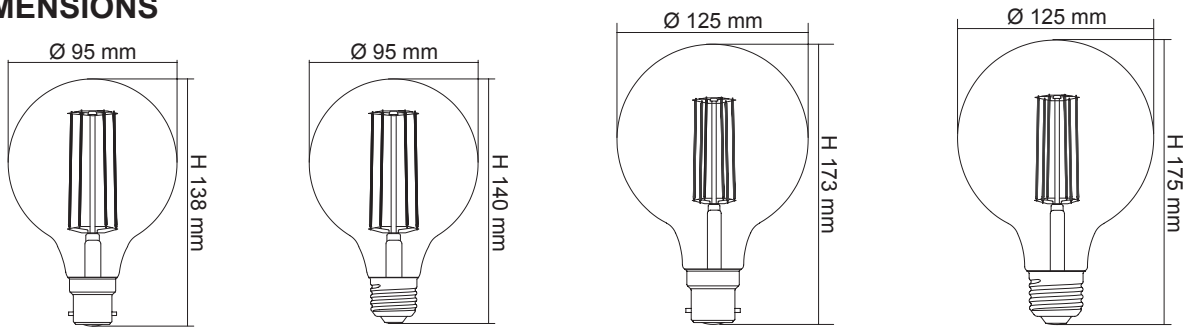

### CONSTRUCTION

- Clear glass diffuser
- High efficiency LED filament
- High colour rendering
- Built-in trailing edge dimmable LED driver
- 360° beam angle
- Double insulation

### COLOUR TEMPERATURE

- 2700K Warm White
- 5000K Neutral Daylight

### LAMP BASE

- B22
- E27

### FEATURES

- 1:1 size to traditional spherical lamp
- Trailing edge dimmable
- Suits most spherical lamp fittings

Model No.	Input	Power	Lumen	Beam Angle	CCT	CRI	Dimmable	Lamp Base	Approximately equivalent to incandescent
LG95/27B22D/C	240V	6W	750lm	360°	2700K	>80	Yes*	B22	
LG95/27E27D/C	240V	6W	750lm	360°	2700K	>80	Yes*	E27	
LG95/50B22D/C	240V	6W	800lm	360°	5000K	>80	Yes*	B22	
LG95/50E27D/C	240V	6W	800lm	360°	5000K	>80	Yes*	E27	
Model No.	Input	Power	Lumen	Beam Angle	CCT	CRI	Dimmable	Lamp Base	Approximately equivalent to incandescent
LG125/27B22D/C	240V	8W	950lm	360°	2700K	>80	Yes*	B22	
LG125/27E27D/C	240V	8W	950lm	360°	2700K	>80	Yes*	E27	
LG125/50B22D/C	240V	8W	1000lm	360°	5000K	>80	Yes*	B22	
LG125/50E27D/C	240V	8W	1000lm	360°	5000K	>80	Yes*	E27	

\*Trailing edge dimming

# LED SMD SPHERICAL LAMP

## LG95, LG125 OPAL



### DIMENSIONS

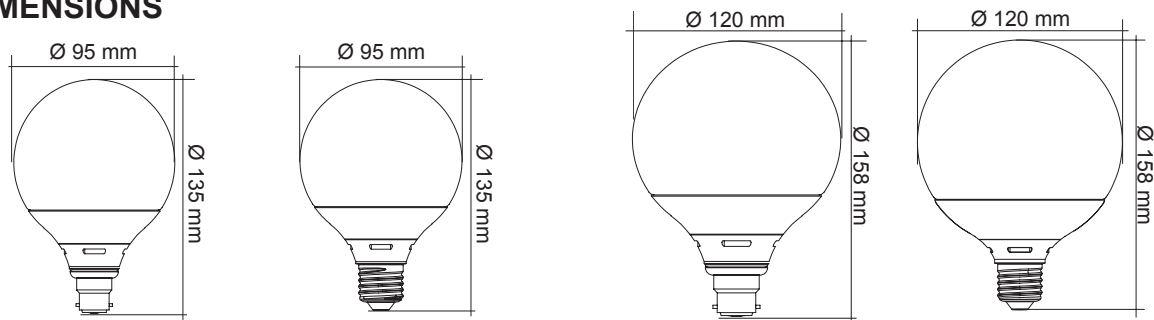

### CONSTRUCTION

- Opal polycarbonate diffuser
- Poly covered aluminium body
- High efficiency SMD LED chips
- Built-in trailing edge dimmable LED driver
- Wide beam angle
- Double insulation

### COLOUR TEMPERATURE

- 3000K Warm White
- 6000K Neutral Daylight

### LAMP BASE

- B22
- E27

### FEATURES

- 1:1 size to traditional spherical lamp
- Suits most spherical lamp fittings

Model No.	Input	Power	Lumen	CCT	Beam Angle	CRI	Dimmable	Lamp Base	Approximately equivalent to incandescent
LG95/830B22	240V	10W	900lm	3000K	270°	>80	Yes*	B22	
LG95/860B22	240V	10W	950lm	6000K	270°	>80	Yes*	B22	
LG95/830E27	240V	10W	900lm	3000K	270°	>80	Yes*	E27	
LG95/860E27	240V	10W	950lm	6000K	270°	>80	Yes*	E27	

Model No.	Input	Power	Lumen	CCT	Beam Angle	CRI	Dimmable	Lamp Base	Approximately equivalent to incandescent
LG125/830B22	240V	13W	1100lm	3000K	270°	>80	Yes*	B22	
LG125/860B22	240V	13W	1200lm	6000K	270°	>80	Yes*	B22	
LG125/830E27	240V	13W	1100lm	3000K	270°	>80	Yes*	E27	
LG125/860E27	240V	13W	1200lm	6000K	270°	>80	Yes*	E27	

\*Trailing edge dimming



# LED SMD GLS STYLE LAMP

## LGS4, LGS8, LGS10 OPAL



### DIMENSIONS

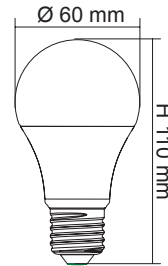
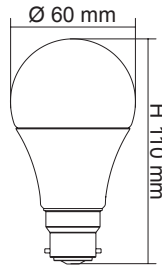

### CONSTRUCTION

- Opal polycarbonate diffuser
- Poly covered aluminium body
- High efficiency SMD LED chips
- Built-in non-dimmable LED driver
- Wide beam angle
- Double insulation 

### FEATURES

- 1:1 size to traditional GLS lamp
- Suits most GLS lamp fittings

### COLOUR TEMPERATURE

- 3000K Warm White
- 4000K Cool White
- 6000K Daylight

### LAMP BASE

- B22
- E27

Model No.	Input	Power	Lumen	CCT	Beam Angle	CRI	Dimmable	Lamp Base	Approximately equivalent to incandescent
LGS4/830B22	240V	4W	350lm	3000K	270°	>80	No	B22	
LGS4/840B22	240V	4W	400lm	4000K	270°	>80	No	B22	
LGS4/860B22	240V	4W	480lm	6000K	270°	>80	No	B22	
LGS4/830E27	240V	4W	350lm	3000K	270°	>80	No	E27	
LGS4/840E27	240V	4W	400lm	4000K	270°	>80	No	E27	
LGS4/860E27	240V	4W	480lm	6000K	270°	>80	No	E27	

Model No.	Input	Power	Lumen	CCT	Beam Angle	CRI	Dimmable	Lamp Base	Approximately equivalent to incandescent
LGS8/830B22	240V	8W	700lm	3000K	270°	>80	No	B22	
LGS8/840B22	240V	8W	750lm	4000K	270°	>80	No	B22	
LGS8/860B22	240V	8W	800lm	6000K	270°	>80	No	B22	
LGS8/830E27	240V	8W	700lm	3000K	270°	>80	No	E27	
LGS8/840E27	240V	8W	750lm	4000K	270°	>80	No	E27	
LGS8/860E27	240V	8W	800lm	6000K	270°	>80	No	E27	

Model No.	Input	Power	Lumen	CCT	Beam Angle	CRI	Dimmable	Lamp Base	Approximately equivalent to incandescent
LGS10/830B22	240V	10W	950lm	3000K	270°	>80	No	B22	
LGS10/840B22	240V	10W	1000lm	4000K	270°	>80	No	B22	
LGS10/860B22	240V	10W	1050lm	6000K	270°	>80	No	B22	
LGS10/830E27	240V	10W	950lm	3000K	270°	>80	No	E27	
LGS10/840E27	240V	10W	1000lm	4000K	270°	>80	No	E27	
LGS10/860E27	240V	10W	1050lm	6000K	270°	>80	No	E27	



www.sal.net.au



# LED SMD GLS STYLE LAMP

## LGS14D OPAL



### DIMENSIONS

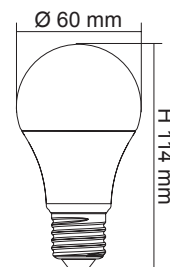
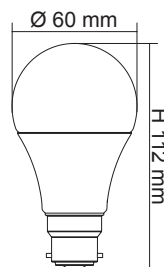

### CONSTRUCTION

- Opal polycarbonate diffuser
- Poly covered aluminium body
- High efficiency SMD LED chips
- Built-in trailing edge dimmable LED driver
- Wide beam angle
- Double insulation

### FEATURES

- 1:1 size to traditional GLS lamp
- Suits most GLS lamp fittings

### COLOUR TEMPERATURE

- 3000K Warm White
- 4000K Cool White
- 6000K Daylight

### LAMP BASE

- B22
- E27

Model No.	Input	Power	Lumen	CCT	Beam Angle	CRI	Dimmable	Lamp Base	Approximately equivalent to incandescent
LGS14/830B22D	240V	14W	1250lm	3000K	270°	>80	Yes*	B22	
LGS14/840B22D	240V	14W	1300lm	4000K	270°	>80	Yes*	B22	
LGS14/860B22D	240V	14W	1350lm	6000K	270°	>80	Yes*	B22	
LGS14/830E27D	240V	14W	1250lm	3000K	270°	>80	Yes*	E27	
LGS14/840E27D	240V	14W	1300lm	4000K	270°	>80	Yes*	E27	
LGS14/860E27D	240V	14W	1350lm	6000K	270°	>80	Yes*	E27	



\*Trailing edge dimming

# LED SMD TUBULAR LAMP

## LT407



### DIMENSIONS

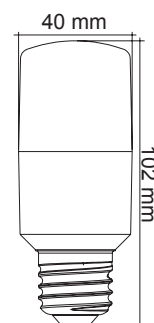
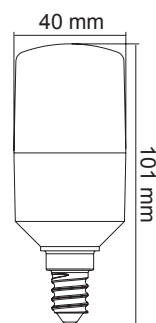
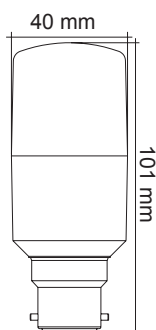
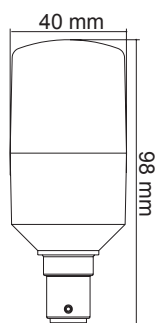

### CONSTRUCTION

- Opal polycarbonate diffuser
- Poly covered aluminium body
- High efficiency SMD LED chips
- Built-in non-dimmable LED driver
- Wide beam angle
- Double insulation 

### FEATURE

- Suits most CFL lamp fittings

### COLOUR TEMPERATURE

- 3000K Warm White
- 4000K Cool White
- 6000K Daylight

### LAMP BASE

- B15
- B22
- E14
- E27

Model No.	Input	Power	Lumen	CCT	Beam Angle	CRI	Dimmable	Lamp Base	Approximately equivalent to incandescent
LT407/27B15	240V	7W	650lm	3000K	270°	>80	No	B15	
LT407/40B15	240V	7W	700lm	4000K	270°	>80	No	B15	
LT407/65B15	240V	7W	750lm	6000K	270°	>80	No	B15	
LT407/27B22	240V	7W	650lm	3000K	270°	>80	No	B22	
LT407/40B22	240V	7W	700lm	4000K	270°	>80	No	B22	
LT407/65B22	240V	7W	750lm	6000K	270°	>80	No	B22	
LT407/27E14	240V	7W	650lm	3000K	270°	>80	No	E14	
LT407/40E14	240V	7W	700lm	4000K	270°	>80	No	E14	
LT407/65E14	240V	7W	750lm	6000K	270°	>80	No	E14	
LT407/27E27	240V	7W	650lm	3000K	270°	>80	No	E27	
LT407/40E27	240V	7W	700lm	4000K	270°	>80	No	E27	
LT407/65E27	240V	7W	750lm	6000K	270°	>80	No	E27	

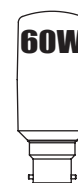

# LED SMD TUBULAR LAMP

## LT409, LT409D



### DIMENSIONS

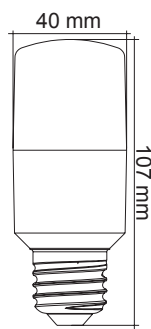
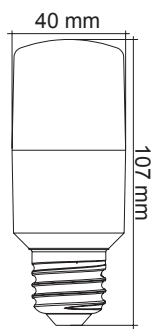
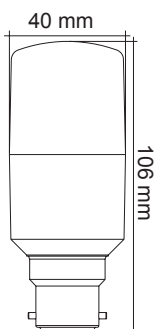
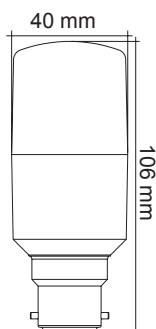

### CONSTRUCTION

- Opal polycarbonate diffuser
- Poly covered aluminium body
- High efficiency SMD LED chips
- Built-in non-dimmable LED driver
- Trailing edge dimmable models available
- Wide beam angle
- Double insulation 

### FEATURE

- Suits most CFL lamp fittings

### COLOUR TEMPERATURE

- 3000K Warm White
- 4000K Cool White
- 6000K Daylight

### LAMP BASE

- B22
- E27

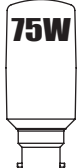
Model No.	Input	Power	Lumen	CCT	Beam Angle	CRI	Dimmable	Lamp Base	Approximately equivalent to incandescent
LT409/27B22	240V	9W	850lm	3000K	270°	>80	No	B22	
LT409/40B22	240V	9W	900lm	4000K	270°	>80	No	B22	
LT409/65B22	240V	9W	950lm	6000K	270°	>80	No	B22	
LT409/27E27	240V	9W	850lm	3000K	270°	>80	No	E27	
LT409/40E27	240V	9W	900lm	4000K	270°	>80	No	E27	
LT409/65E27	240V	9W	950lm	6000K	270°	>80	No	E27	

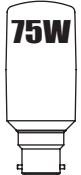
Model No.	Input	Power	Lumen	CCT	Beam Angle	CRI	Dimmable	Lamp Base	Approximately equivalent to incandescent
LT409/27B22D	240V	9W	850lm	3000K	270°	>80	Yes*	B22	
LT409/40B22D	240V	9W	900lm	4000K	270°	>80	Yes*	B22	
LT409/65B22D	240V	9W	950lm	6000K	270°	>80	Yes*	B22	
LT409/27E27D	240V	9W	850lm	3000K	270°	>80	Yes*	E27	
LT409/40E27D	240V	9W	900lm	4000K	270°	>80	Yes*	E27	
LT409/65E27D	240V	9W	950lm	6000K	270°	>80	Yes*	E27	

\*Trailing edge dimming

Specifications above are for reference only and may vary without prior notice



www.sal.net.au

# LED TUBE LT8

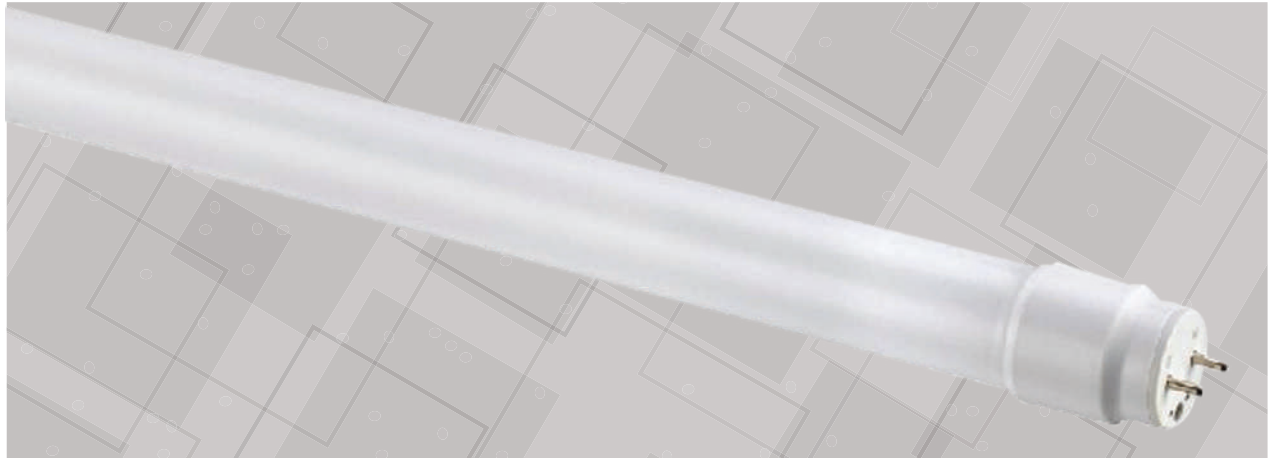

## DIMENSIONS

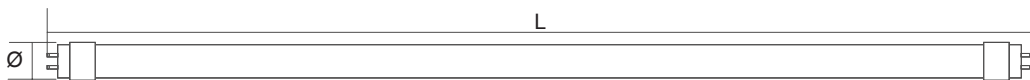

## WIRING DIAGRAM

New luminaire example

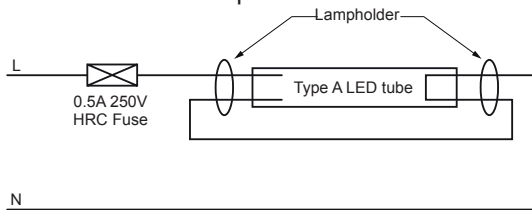

Retrofit or Modified luminaires:

- Refer to AS/NZS60598.2.1:2014 for wiring diagrams

**IMPORTANT WARNING:** The luminaire that these LED tubes are installed in may need to be converted in accordance with AS/NZS60598.2.1:2014 by a suitably qualified person. In **all** instances any electronic components (i.e. driver, electronic ballast, capacitor) must be removed from the circuit.

## CONSTRUCTION

- Fit new T8 LED fixture or retrofit T8 fluorescent fixture (Magnetic Ballast)
- Shatter proof poly coated full glass body
- High efficiency SMD LED chips
- Built-in non-dimmable LED driver
- Wide beam angle
- No flicker, instant start
- Safety LED fuse included

## COLOUR TEMPERATURE

- 3000K Warm White
- 4000K Cool White
- 6000K Daylight

## LAMP BASE

- G13

Model No.	Input	Power	Lumen	CCT	Beam Angle	CRI	Dimmable	Dimensions Ø x L	Lamp Base
LT8/60WW	240V	9W	900lm	3000K	320°	>80	No	26 x 600 mm	G13
LT8/60CW	240V	9W	950lm	4000K	320°	>80	No	26 x 600 mm	G13
LT8/60DL	240V	9W	1000lm	6000K	320°	>80	No	26 x 600 mm	G13

Model No.	Input	Power	Lumen	CCT	Beam Angle	CRI	Dimmable	Dimensions Ø x L	Lamp Base
LT8/120WW	240V	18W	1800lm	3000K	320°	>80	No	26 x 1200 mm	G13
LT8/120CW	240V	18W	1900lm	4000K	320°	>80	No	26 x 1200 mm	G13
LT8/120DL	240V	18W	2000lm	6000K	320°	>80	No	26 x 1200 mm	G13

# LED DIRECTIONAL LAMP

## AR111 LAMP

### CONSTRUCTION

- Die-cast aluminium body
- High output COB LED chip
- Specially designed optical lens
- 12V AC or DC driver required
- Standard beam angle 24°

### FEATURES

- Compatible with most electronic transformers
- Suits most halogen AR111 lamp fittings

### COLOUR TEMPERATURE

- 3000K Warm White



### BEAM ANGLE OPTION

- 40° optical lens

### LAMP BASE

- G53

### DIMENSIONS

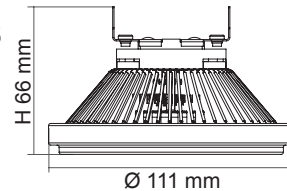

Model No.	Input	Power	Lumen	CCT	Beam Angle	CRI	Dimmable
AR111/700WW LED	12V AC or DC	12W	750lm	3000K	24°	>80	Yes*

\*Dimmable with MINI60

# LED DIRECTIONAL LAMP

## AR111 MODULE

### CONSTRUCTION

- Die-cast aluminium body
- High output COB LED chip
- Specially designed optical lens
- Changeable multi-reflector system
- Constant current LED driver required

### BEAM ANGLE

- 24° (standard)
- AR111/1700: 40° (option)
- AR111/3500: 20°, 60° (option)

### COLOUR TEMPERATURE

- 3000K Warm White (standard)
- AR111/1700: 4000K Cool White (standard)

### DIMENSIONS

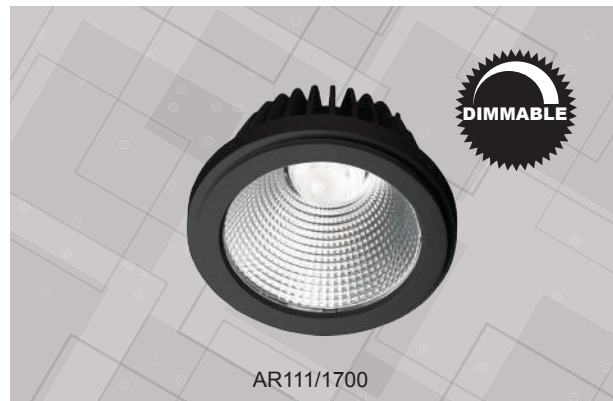
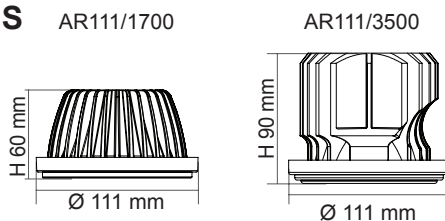

Model No.	Input	Power	Lumen	CCT	Beam Angle	CRI	Dimmable	Suggested Driver
AR111/1700WW LED	500mA	20W	1700lm	3000K	24°	>80	Yes*	DIM500MA/18W
AR111/1700CW LED	500mA	20W	1700lm	4000K	24°	>80	Yes*	DIM500MA/18W
AR111/3500WW	1050mA	35W	3300lm	3000K	40°	>80	No	PLUTO1050MA/40W

\*Dimmable with trailing edge dimming control gear



www.sal.net.au

Specifications above are for reference only and may vary without prior notice

# LED DIRECTIONAL MR16 LAMP

## MR16 5W, MR16 7W, MR16 DIM9W



### DIMENSIONS

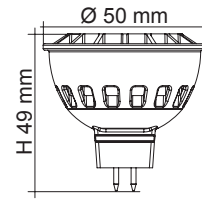
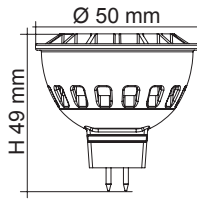
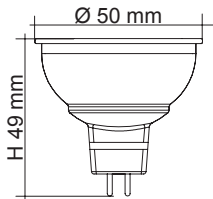

### CONSTRUCTION

- Shockproof frosted polycarbonate lens
- Poly covered aluminium body (MR16 5W)
- Die-cast aluminium body (MR16 7W, MR16DIM9W)
- High efficiency SMD LED chips
- 12V AC or DC driver required

### FEATURES

- Directly replace MR16 halogen lamp
- Compatible with all leading brand electronic transformers
- Suits most halogen MR16 fittings

### COLOUR TEMPERATURE

- 3000K Warm White
- 6000K Daylight

### LAMP BASE

- GU5.3

Model No.	Input	Power	Lumen	CCT	Beam Angle	CRI	Dimmable	Lamp Base
MR16 5W WW	12V AC or DC	5W	330lm	3000K	38°	>80	No	GU5.3
MR16 5W DL	12V AC or DC	5W	350lm	6000K	38°	>80	No	GU5.3

Model No.	Input	Power	Lumen	CCT	Beam Angle	CRI	Dimmable	Lamp Base
MR16/7W/WW	12V AC or DC	7W	500lm	3000K	60°	>80	No	GU5.3
MR16/7W/DL	12V AC or DC	7W	550lm	6000K	60°	>80	No	GU5.3

Model No.	Input	Power	Lumen	CCT	Beam Angle	CRI	Dimmable	Lamp Base
MR16DIM9W/WW	12V AC or DC	9W	500lm	3000K	60°	>80	Yes*	GU5.3
MR16DIM9W/DL	12V AC or DC	9W	550lm	6000K	60°	>80	Yes*	GU5.3

\*Trailing edge dimming



# LED DIRECTIONAL GU10 LAMP

## GU10L350, GU10L550, GU10LA750, GU10LR750



### DIMENSIONS

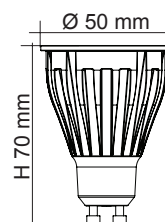
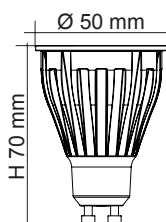
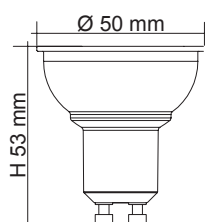

### CONSTRUCTION

- Shockproof frosted polycarbonate lens
- Poly covered aluminium body
- High efficiency SMD LED chips
- Built-in LED driver
- Dimmable models
- Double insulation

### COLOUR TEMPERATURE

- 3000K Warm White
- 4000K Cool White
- 6000K Daylight

### LAMP BASE

- GU10

### FEATURE

- Suits most halogen GU10 fittings

Model No.	Input	Power	Lumen	Beam Angle	CCT	CRI	Dimmable	Lamp Base
GU10L350WW	240V	4W	300lm	38°	3000K	>80	No	GU10
GU10L350CW	240V	4W	330lm	38°	4000K	>80	No	GU10
GU10L350DL	240V	4W	350lm	38°	6000K	>80	No	GU10

Model No.	Input	Power	Lumen	Beam Angle	CCT	CRI	Dimmable	Lamp Base
GU10L550WW	240V	6W	500lm	50°	3000K	>80	No	GU10
GU10L550CW	240V	6W	530lm	50°	4000K	>80	No	GU10
GU10L550DL	240V	6W	550lm	50°	6000K	>80	No	GU10

Model No.	Input	Power	Lumen	Beam Angle	CCT	CRI	Dimmable	Lamp Base
GU10LR750WW	240V	9W	700lm	60°	3000K	>80	No	GU10
GU10LR750CW	240V	9W	730lm	60°	4000K	>80	No	GU10
GU10LR750DL	240V	9W	750lm	60°	6000K	>80	No	GU10

Model No.	Input	Power	Lumen	Beam Angle	CCT	CRI	Dimmable	Lamp Base
GU10LA750WW	240V	9W	700lm	60°	3000K	>80	Yes*	GU10
GU10LA750CW	240V	9W	730lm	60°	4000K	>80	Yes*	GU10
GU10LA750DL	240V	9W	750lm	60°	6000K	>80	Yes*	GU10

\*Trailing edge dimming



www.sal.net.au

Specifications above are for reference only and may vary without prior notice

# LED DIRECTIONAL R LAMP

## LR50, LR63, LR80, LR95



### DIMENSIONS

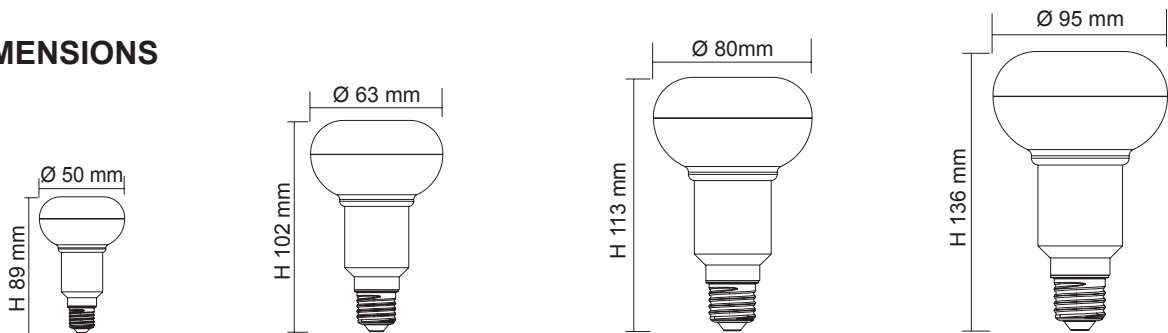

### CONSTRUCTION

- Opal polycarbonate diffuser
- Poly covered aluminium body
- High efficiency SMD LED chips
- Built-in non-dimmable LED driver
- Double insulation 

### COLOUR TEMPERATURE









- 3000K Warm White
- 6000K Daylight

### LAMP BASE

- E14
- E27

### FEATURES

- 1:1 size to traditional R lamp
- Suits most R lamp fittings

Model No.	Input	Power	Lumen	CCT	Beam Angle	CRI	Dimmable	Lamp Base	Approximately equivalent to incandescent
LR50WW	240V	7W	650lm	3000K	120°	>80	No	E14	
LR50DL	240V	7W	650lm	6000K	120°	>80	No	E14	
LR63WW	240V	7W	650lm	3000K	120°	>80	No	E27	
LR63DL	240V	7W	650lm	6000K	120°	>80	No	E27	
LR80WW	240V	9W	850lm	3000K	120°	>80	No	E27	
LR80DL	240V	9W	850lm	6000K	120°	>80	No	E27	
LR95WW	240V	9W	850lm	3000K	120°	>80	No	E27	
LR95DL	240V	9W	850lm	6000K	120°	>80	No	E27	

# LED DIRECTIONAL PAR LAMP

## LPAR20, LPAR30, LPAR38

**IP65**



### DIMENSIONS

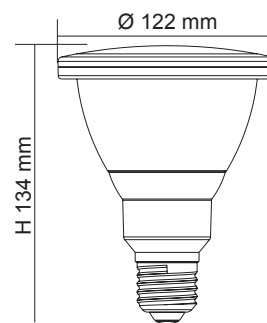
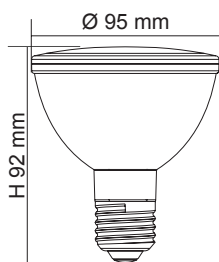
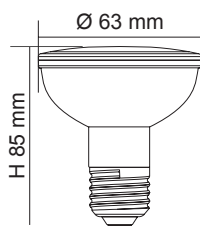

### CONSTRUCTION

- Opal polycarbonate diffuser
- Poly covered aluminium body
- High efficiency SMD LED chips
- Built-in non-dimmable LED driver
- Double insulation 

### FEATURES

- 1:1 size to traditional PAR lamp
- Suits most PAR lamp fittings

### COLOUR TEMPERATURE



- 3000K Warm White
- 6000K Daylight

### LAMP BASE

- E27

### IP RATING

- IP65 weatherproof

Model No.	Input	Power	Lumen	CCT	Beam Angle	CRI	Dimmable	Lamp Base	Approximately equivalent to incandescent
LPAR20WW	240V	7W	600lm	3000K	100°	>80	No	E27	
LPAR20DL	240V	7W	600lm	6000K	100°	>80	No	E27	
LPAR30WW	240V	9W	800lm	3000K	100°	>80	No	E27	
LPAR30DL	240V	9W	800lm	6000K	100°	>80	No	E27	
LPAR38WW	240V	12W	1050lm	3000K	100°	>80	No	E27	
LPAR38DL	240V	12W	1050lm	6000K	100°	>80	No	E27	

# LED SPECIAL LAMP

## G4L15, G4L25

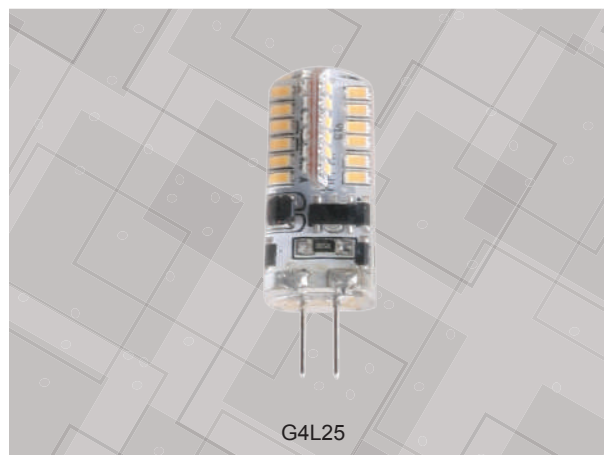
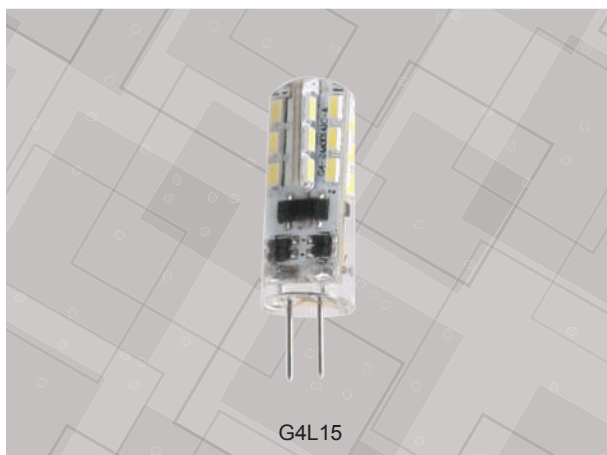

### DIMENSIONS

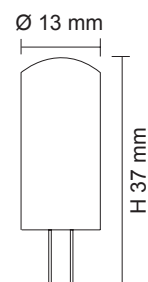
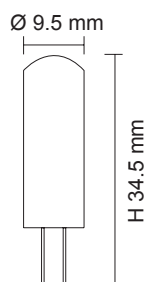

### CONSTRUCTION

- Transparent silicone body
- High efficiency SMD LED chips
- 12V AC or DC driver required
- Wide beam angle

### FEATURES

- Compatible with most electronic transformers
- Suits most G4 lamp fittings

### COLOUR TEMPERATURE

- 3000K Warm White
- 6000K Daylight

### LAMP BASE

- G4

Model No.	Input	Power	Lumen	CCT	Beam Angle	CRI	Dimmable	Lamp Base
G4L15WW	12V AC or DC	1.5W	90lm	3000K	270°	>80	No	G4
G4L15DL	12V AC or DC	1.5W	100lm	6000K	270°	>80	No	G4

Model No.	Input	Power	Lumen	CCT	Beam Angle	CRI	Dimmable	Lamp Base
G4L25WW	12V AC or DC	2.5W	160lm	3000K	270°	>80	No	G4
G4L25DL	12V AC or DC	2.5W	180lm	6000K	270°	>80	No	G4

# LED SPECIAL LAMP

## G9L



### CONSTRUCTION

- Opal polycarbonate body
- High efficiency SMD LED chips
- Built-in trailing edge dimmable LED driver
- 360° beam angle
- Double insulation

### FEATURE

- Suits most G9 lamp fittings

### COLOUR TEMPERATURE

- 3000K Warm White
- 6000K Daylight

### LAMP BASE

- G9



### DIMENSIONS

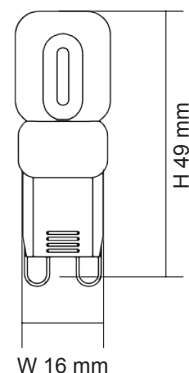

Model No.	Input	Power	Lumen	Beam Angle	CCT	CRI	Dimmable	Lamp Base
G9L3D/ WW	240V	2.5W	200lm	360°	3000K	>80	Yes*	G9
G9L3D/ DL	240V	2.5W	220lm	360°	6000K	>80	Yes*	G9

\*Trailing edge analogue dimming only

# LED SPECIAL LAMP

## GX53

### CONSTRUCTION

- Frosted glass diffuser
- Poly covered aluminium body
- High efficiency SMD LED chips
- Built-in non-dimmable LED driver
- Double insulation

### FEATURE

- Suits most GX53 lamp fittings

### COLOUR TEMPERATURE

- 3000K Warm White
- 4000K Cool White
- 6000K Daylight

### LAMP BASE

- GX53



### DIMENSIONS

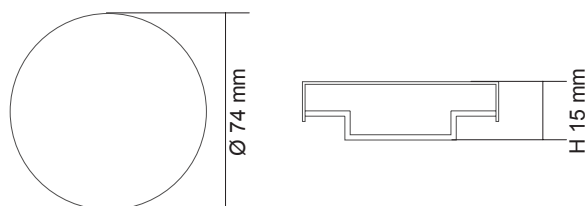

Model No.	Input	Power	Lumen	Beam Angle	CCT	CRI	Dimmable	Lamp Base
GX53/450 WW	240V	5W	420lm	120°	3000K	>80	No	GX53
GX53/450 CW	240V	5W	430lm	120°	4000K	>80	No	GX53
GX53/450 DL	240V	5W	450lm	120°	6000K	>80	No	GX53

# LED CONVERSION KIT

## SLC21, SLC30



### DIMENSIONS

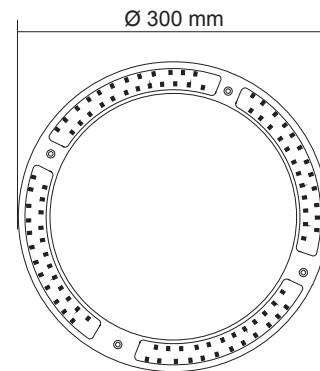
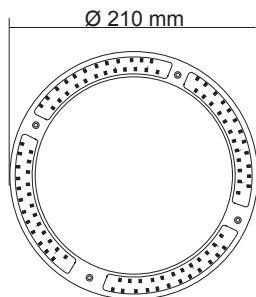

### CONSTRUCTION

- Aluminium heat sink mounted base
- High efficiency SMD LED chips
- High colour rendering
- Constant current non-dimmable  
LED driver included
- Requires installation into suitable fitting

### FEATURES

- Suits most oyster fittings
- Supplied with clips & screws for easy assembly



### OPTION

- Trailing edge dimming option (SLC30 only)

Model No.	Input	Power	Lumen	CCT	CRI	Dimmable
SLC21/WW	240V	12W	1200lm	3000K	>80	No
SLC21/CW	240V	12W	1200lm	4000K	>80	No
SLC21/DL	240V	12W	1200lm	6000K	>80	No
SLC30/WW	240V	20W	1800lm	3000K	>80	No
SLC30/CW	240V	20W	1800lm	4000K	>80	No
SLC30/DL	240V	20W	1800lm	6000K	>80	No



# LED CONVERSION KIT

## LCT21TC, LCT30TC



### DIMENSIONS

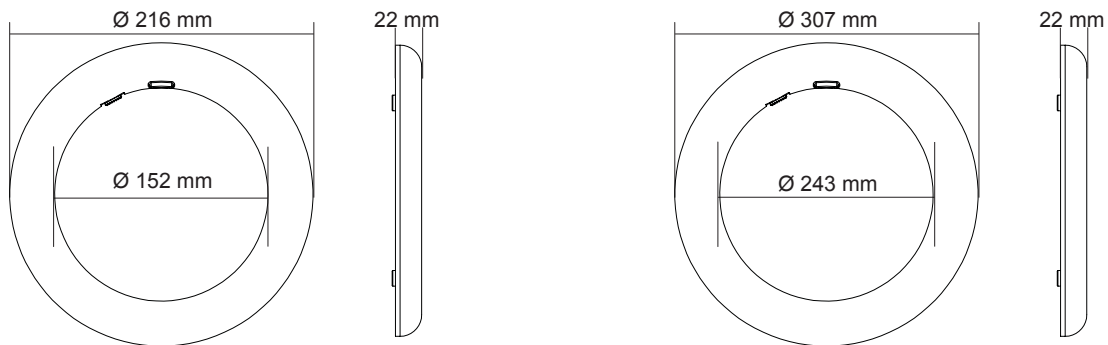

### CONSTRUCTION

- Clear polycarbonate lens
- Aluminium heat sink mounted base
- High efficiency SMD LED chips
- High colour rendering
- Built-in trailing edge dimmable LED driver
- 100 mm 3 core PVC flex (LCT21TC), 160 mm 3 core PVC flex (LCT30TC)
- Requires installation into suitable fitting

### FEATURES

- Select colour temperature with DIP switch
- Suits most oyster fittings
- Magnetic button at the back
- Supplied with clips & screws for easy assembly
- Trailing edge dimmable



Model No.	Input	Power	Lumen	CCT	CRI	Dimmable
LCT21TC	240V	12W	1100lm/1300lm/1200lm	3000K/4000K/5700K	>80	Yes*
LCT30TC	240V	20W	1800lm/2000lm/1900lm	3000K/4000K/5700K	>80	Yes*

\*Trailing edge dimming

# CONSTANT VOLTAGE LED DRIVER

## PLUTO, PLUTO EGL

- Independent compact design
- Captured terminal screws
- Safe no load operation
- Overload protection
- Short circuit protection
- Overheating protection
- SELV and EMC compliant
- 1.2 m flex & 3 pin plug fitted (PLUTO 30, PLUTO 100, PLUTO 200)

### WIRING DIAGRAM

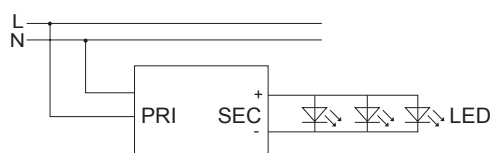

### DIMENSIONS

PLUTO EGL

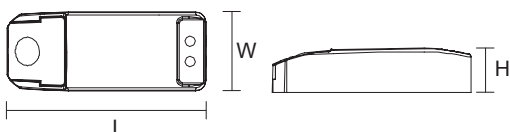

PLUTO 50

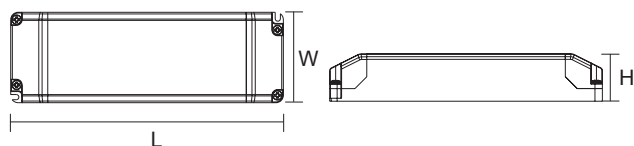

PLUTO 30, PLUTO 100, PLUTO 200

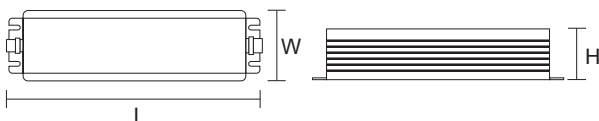

PLUTO EGL



PLUTO 50



PLUTO 30, PLUTO 100, PLUTO 200

Model No.	Input	Power	Output	Power Factor	Dimensions L x W x H	IP Rating
PLUTO EGL 12V/6W	240V	6W	12V	0.6	81 x 40 x 22 mm	IP20
PLUTO EGL 12V/15W	240V	15W	12V	0.8	113 x 44 x 28 mm	IP20
PLUTO 15/24V	240V	15W	24V	0.8	113 x 44 x 28 mm	IP20
PLUTO 50/12V	240V	50W	12V	0.95	184 x 61 x 32 mm	IP20
PLUTO 50/24V	240V	50W	24V	0.95	184 x 61 x 32 mm	IP20
PLUTO 30/12V	240V	30W	12V	0.95	169 x 55 x 30 mm	IP67
PLUTO 30/24V	240V	30W	24V	0.95	169 x 55 x 30 mm	IP67
PLUTO 100/12V	240V	100W	12V	0.95	192 x 70 x 40 mm	IP67
PLUTO 100/24V	240V	100W	24V	0.95	192 x 70 x 40 mm	IP67
PLUTO 200/12V	240V	200W	12V	0.95	249 x 70 x 40 mm	IP67
PLUTO 200/24V	240V	200W	24V	0.95	249 x 70 x 40 mm	IP67

# DIMMABLE CONSTANT VOLTAGE LED DRIVER

## DIM100W, DIM200W, DIM110/150W, DIM40W/12V

- Suitable for LED strip
- Trailing edge or 1-10V dimming models
- Independent compact design
- Safe no load operation
- Overload protection
- Short circuit protection
- Overheating protection
- SELV and EMC compliant
- 1.2 m flex & 3 pin plug fitted (DIM100W, DIM200W, DIM110/150W)
- 1.2 m flex & 2 pin plug fitted (DIM40W)
- Output fly leads at secondary end

### RECOMMENDED TRAILING EDGE DIMMERS

- SDA450
- SDD350TCM

### RECOMMENDED 1-10V CONTROLLER

- SDF30

### APPLICATION

- Use with LED strip

### WIRING DIAGRAM

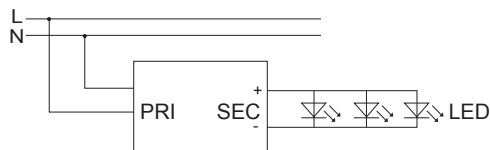

### DIMENSIONS

DIM100W, DIM200W, DIM110/150W

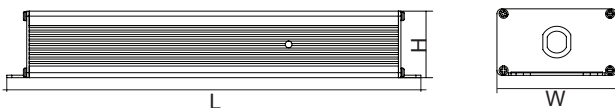

DIM40W/12V

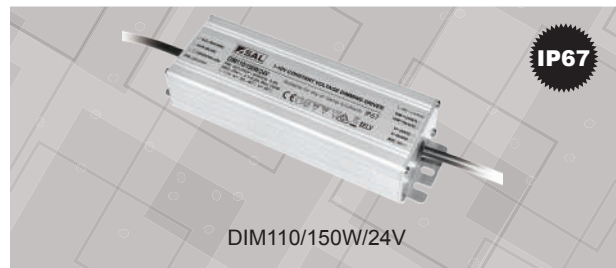
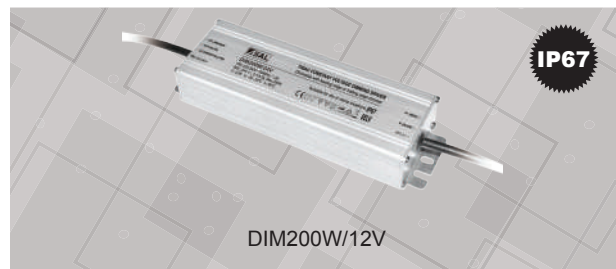
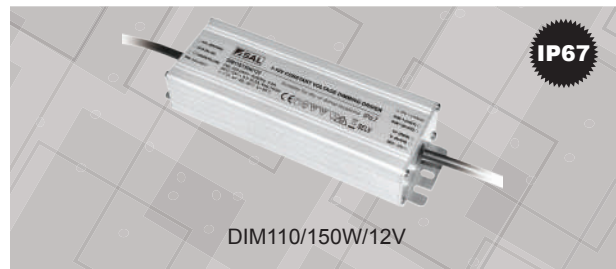
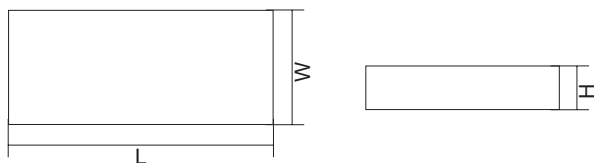

Model No.	Input	Power	Min. Load	Power Factor	Output	Dimensions L x W x H	Dimming Type	Working Temperature
DIM40W/12V	240V	40W	5W	>0.90	12V	110 x 60 x 33 mm	Trailing edge	-20°C ~ 50°C
DIM100W/12V	240V	100W	33W	>0.90	12V	191 x 70 x 40 mm	Trailing edge	-20°C ~ 50°C
DIM100W/24V	240V	100W	33W	>0.90	24V	191 x 70 x 40 mm	Trailing edge	-20°C ~ 50°C
DIM200W/12V	240V	200W	60W	>0.90	12V	249 x 72 x 40 mm	Trailing edge	-20°C ~ 50°C
DIM200W/24V	240V	200W	60W	>0.90	24V	249 x 72 x 40 mm	Trailing edge	-20°C ~ 50°C
DIM110/150W/12V	240V	150W	50W	>0.90	12V	223 x 70 x 40 mm	1-10V	-20°C ~ 50°C
DIM110/150W/24V	240V	150W	50W	>0.90	24V	223 x 70 x 40 mm	1-10V	-20°C ~ 50°C

# DIMMABLE CONSTANT CURRENT LED DRIVER

## PLUTO 350mA, 500mA, 700mA, 1400mA

- Independent compact design
- Captured terminal screws
- Safe no load operation
- Overload protection
- Short circuit protection
- Overheating protection
- SELV and EMC compliant
- Dimmable with trailing edge dimmer
- Dimming range 10%~100%

### IP RATING

- IP20 suitable for interior use only

### RECOMMENDED DIMMERS

- SDA450
- SDD350TCM and SDD350TCS
- SDD350BT

### WIRING DIAGRAM

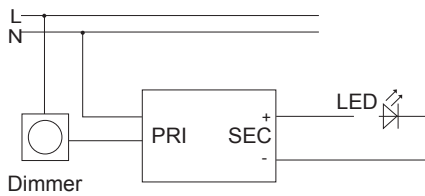

### DIMENSIONS

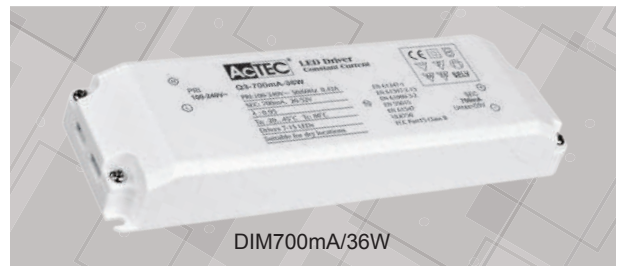
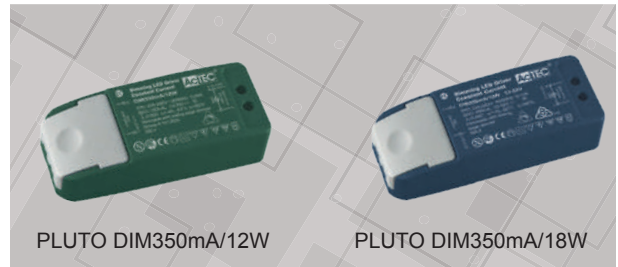
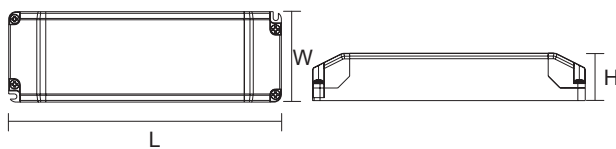

Model No.	Input	Max. Output Power	Output	Output Current	Power Factor	Dimensions L x W x H
<b>DIM350mA/12W</b>	240V	12W	18~35V	350mA	0.90	98 x 39 x 22 mm
<b>DIM350mA/18W</b>	240V	18W	15~52V	350mA	0.90	113 x 44 x 28 mm
<b>DIM500mA/18W</b>	240V	18W	9~36V	500mA	0.90	113 x 44 x 28 mm
<b>DIM700mA/18W</b>	240V	18W	6~26V	700mA	0.90	113 x 44 x 28 mm
<b>DIM700mA/30W</b>	240V	30W	26~43V	700mA	0.90	140 x 45 x 28 mm
<b>DIM700mA/36W</b>	240V	36W	24~52V	700mA	0.90	166 x 52 x 24 mm
<b>DIM1400mA/36W</b>	240V	36W	9~26V	1400mA	0.90	166 x 52 x 24 mm

# ELECTRONIC TRANSFORMER

## MINI60

- Independent compact design
- Captured terminal screws
- High power factor
- Safe no load operation
- Overload protection
- Short circuit protection
- Overheating protection
- SELV and EMC compliant
- Dimmable with trailing edge dimmer
- Dimming range 10%~100%

### IP RATING

- IP20 suitable for interior use only

### RECOMMENDED DIMMERS

- SDA450
- SDD350TCM and SDD350TCS
- SDD350BT

### DIMENSIONS

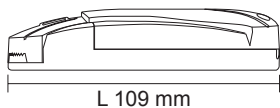

Model No.	Input	Power	Output	Power Factor	1.2 m Flex & PlugFitted
MINI60	240V	20-60W	11.5V	0.99	No
MINI/P60	240V	20-60W	11.5V	0.99	Yes

**OVER  
10 MILLION  
SOLD**



# MAGNETIC WEATHERPROOF AC-AC TRANSFORMER

## ST105, ST150, ST200, ST300, ST400

- Magnetic weatherproof AC-AC transformer
- Safe no load operation
- Overload protection
- Short circuit protection
- Overheating protection
- Double insulation 
- SELV and EMC compliant
- 1.2 m flex & 2 pin plug fitted
- Output fly leads at secondary end

### IP RATING

- IP66 weatherproof

### DIMENSIONS

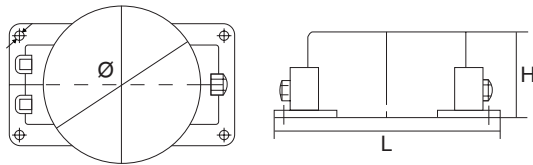

Model No.	Input	Power	Output	Dimensions Ø x L x H
ST105	240V	105W	12V AC	124 x 195 x 80 mm
ST150	240V	150W	12V AC	124 x 195 x 80 mm
ST200	240V	200W	12V AC	138 x 210 x 80 mm
ST300	240V	300W	12V AC	138 x 210 x 80 mm
ST400	240V	400W	12V AC	152 x 225 x 80 mm

# LED EMERGENCY KIT

## SELK2500/SM TRIANGLE

- Non-maintained emergency kit
- Compliant to AS2293. Emergency classification: D32
- LED charge status indicator
- Test switch
- Guaranteed 90 minutes emergency operation
- Intelligent automatic recharging function
- 16 hours charge time
- Deep discharge protection
- SELV compliant
- 3M self-adhesive tape at back
- Can be used with all SAL LED Panel lights



Model No.	Input	Power	CCT	CRI	Beam Angle	Battery Type	Emergency Classification
SELK2500/SM	240V	2W	6000K	>80	120°	2500mAh @ 4.8V	D32



# LED EMERGENCY LIGHT

## SELK1500ISF S-FIRE



### DIMENSIONS

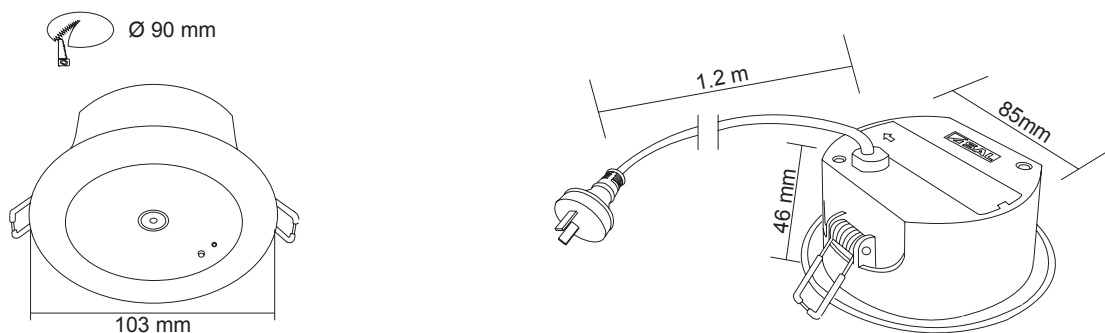

### CONSTRUCTION

- Compliant to AS2293
- Emergency classification: D32
- Polycarbonate body
- Double insulation
- LED charge status display
- Test switch
- Guaranteed 90 minutes emergency operation

- Integral replaceable battery pack
- Intelligent automatic recharging function
- 16 hours charge time
- Deep discharge protection
- 1.2 m flex & 2 pin plug fitted

### IP RATING

- IP20 suitable for interior use only

Model No.	Input	System Power	Recharge Hours	Battery Type	Emergency Classification
SELK1500ISF	240V	1.6W	16 hours	LiFePO <sub>4</sub> 3.2V 1.5Ah	D32

# DIGITAL DIMMER

## 350W TRAILING EDGE MASTER & SECONDARY

### SDD350TCM, SDD350TCS TRAILING EDGE DIMMER

- Trailing edge digital dimming
- Multiple-location dimming by connecting SDD350TCM with any number of secondary dimmers SDD350TCS as shown in “Wiring Diagram”
- Fit most popular switch plates
- Additional button cover included
- Overheating protection
- Over current protection
- Full short circuit protection
- Compliant to AS/NZS6069.2.1

#### DIMENSIONS

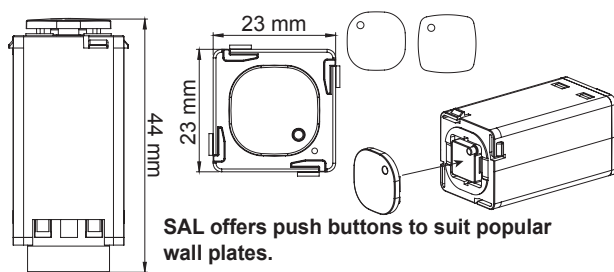

**Note:** An unlimited number of SDD350TCS can be connected to a SDD350TCM. However the total length of the remote wire (>0.5 mm<sup>2</sup>) used to interconnect all of the SDD350TCS should not exceed 50 metres.



SDD350TCM



SDD350TCS

#### WIRING DIAGRAM

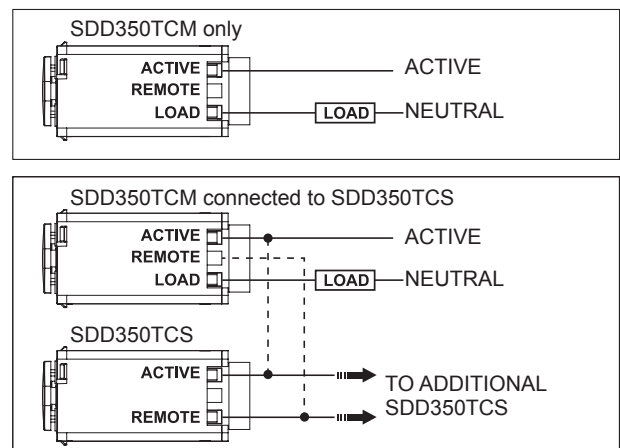

Model No.	Input	Frequency	Max. Load	Min. Load	Dimming Technique
SDD350TCM	240V	50Hz/60Hz	350W	2W*	Trailing edge phase control
SDD350TCS*	240V	50Hz/60Hz	350W	2W*	Trailing edge phase control

\*Dimming performance will be affected when the load is less than 2W. (At 25°C)

\*Secondary Dimmer only. See wiring diagram for details

## DIMMER & CONTROLLER

### SDA450

- Trailing edge analogue dimming
- 240V 450W
- Min. load 10W\*
- Dimensions: 23 x 23 x 53 mm
- Fits most popular switch plates

\*Dimming performance might be affected when the load is less than 10W. (At 25°C)

### SDF30

- 1-10V rotary analogue dimming
- Dimensions: 25 x 25 x 32 mm
- Fits most popular switch plates



SDA450



SDF30

Model No.	Input	Power	Dimensions	Dimming Technique
SDA450	240V	10~450W	23 x 23 x 53mm	Trailing edge phase control
SDF30	–	–	25 x 25 x 32mm	1-10V

# QUICK CONNECT SURFACE SOCKET

## ESS101 QUICK CONNECT SURFACE SOCKET

- Quick Connect surface socket
- 240V 10A surface socket



### INSTALLATION INSTRUCTIONS

1. Remove a slight piece of outer sheathing ONLY to check wire colours for polarity identification.

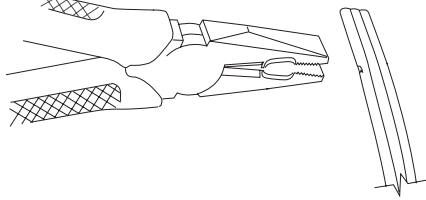

2. Rotate the rear cover to take off the locking ring.  
Note: When connecting 2.5 mm<sup>2</sup> cable, the 1.5mm<sup>2</sup> cable size insert needs to be taken off.

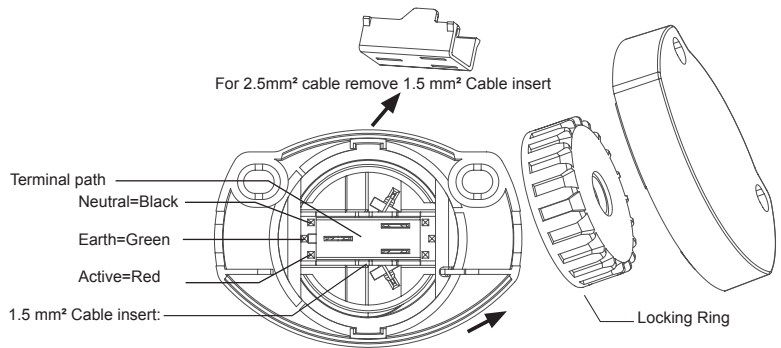

3. Place cable into terminal path. Ensure correct polarity by following colour coding on the terminal path.

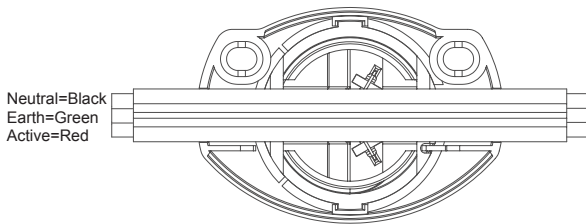

4. Align rectangle ribs with terminal path, push the locking ring and rear cover back down & twist clockwise until it is firmly tightened with the body.

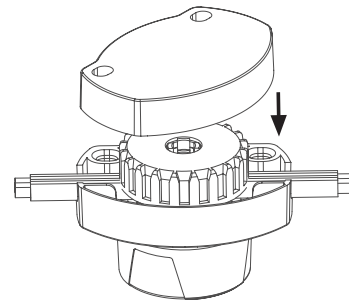

### SURFACE SOCKET

## ESS102 SURFACE SOCKET

- Standard surface socket with mounting plate
- 240V 10A surface socket



Model No.	Input	Max. Current	Type	Suitable Cable Conductor
ESS101	240V	10A	Quick connect	1.5mm, 2.5mm stranded
ESS102	240V	10A	Surface	1mm, 1.5mm, 2.5mm solid or stranded

# DOWNLIGHT ADAPTOR PLATES

## S9901, S9903, S9931, S9933

- Pressed steel plate
- Powder coated or plated finish

### S9901

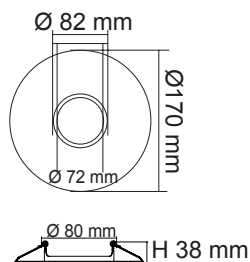

### S9903

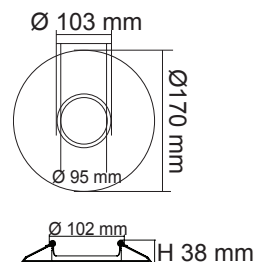

Model No.	Internal Ø	Overall Ø	Colour	Suits
S9901BK	72mm	170mm	Black	
S9901SN	72mm	170mm	Satin Nickel	S9001, S9140, S9045, S9145
S9901WH	72mm	170mm	White	
S9903BK	95mm	170mm	Black	
S9903SN	95mm	170mm	Satin Nickel	S9003, S9041, S9046, S9146, S9048, S9141, S9841
S9903WH	95mm	170mm	White	

### S9931

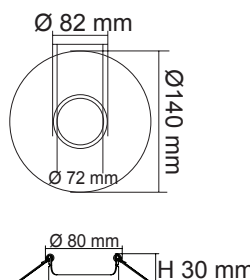

### S9933

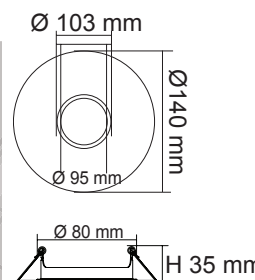

Model No.	Internal Ø	Overall Ø	Colour	Suits
S9931WH	72mm	140mm	White	S9001, S9140, S9045, S9145
S9933WH	95mm	140mm	White	S9003, S9041, S9046, S9146, S9048, S9141, S9841

# REDUCER RINGS

## S9922

- Adaptor plate to suit S9522, S9074, S9545, S9656
- Available colours: White

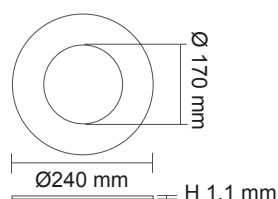
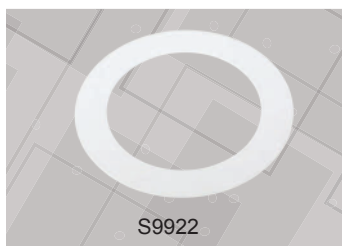

## S9923

- Adaptor plate to suit S9523, S9075
- Available colours: White

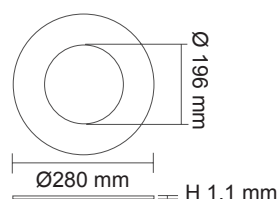
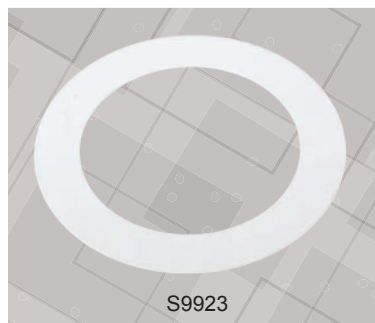

Model No.	Internal Ø	Overall Ø	Colour	Suits
S9922	170mm	240mm	White	S9522, S9074, S9545, S9656
S9923	196mm	280mm	White	S9523, S9075

## 2 PIN FLEX & PLUG 2S9000



- 2 x 0.75 mm<sup>2</sup>
- 1.2 m long
- 240V, 10Amp

Model No.	Conductors	Length	Colour
2S9000	2 x 0.75mm	1200mm	Black

## 3 PIN FLEX & PLUG 3S9000



- 3 x 0.75 mm<sup>2</sup>
- 1.2 m long
- 240V, 10Amp

Model No.	Conductors	Length	Colour
3S9000	3 x 0.75mm	1200mm	Black
3S9000/2	3 x 0.75mm	2000mm	Black

## GU10 LAMPHOLDER SGU9000LH

- 250V Max 2A

Model No.	Input	Lamp Base
SGU9000LH	Hardwired	GU10



## LOW VOLTAGE LAMPHOLDER S9000LH

- Rated Voltage 25V, rated current 5A

Model No.	Input	Lamp Base
S9000LH	Hardwired	MR16



## ES TO BI-PIN LAMPHOLDER CONVERTER M/LV

- 250V Max 2A

Model No.	Input	Lamp Base
CONVERTER M/LV	E27	GU5.3



## E27 LAMPHOLDER SLH100

- 250V Max 100W

Model No.	Input	Lamp Base
SGU9000LH	Hardwired	E27



## LED HEAD LAMP SHL008

- Super bright rechargeable LED head lamp
- Lithium battery for long life
- Adjustable beam angle
- Can be switched between full & half power or flashing
- Detachable long USB lead included
- Adjustable elasticated head strap
- 4 hour battery life from full charge

Model No.	Charging Time	Recharging	Colour
SHL008	4 hours	USB port	Black



# SUSPENSION KIT

## SSI1512, SSY1512

- M10 size ceiling attachment
- 1.2 mm stainless steel cable carrying weight up to 45 kg
- M10 size griplock system

Model No.	Length	Connection
SSI1512	1800mm	"I" Type
SSY1512	1800mm	"Y" Type

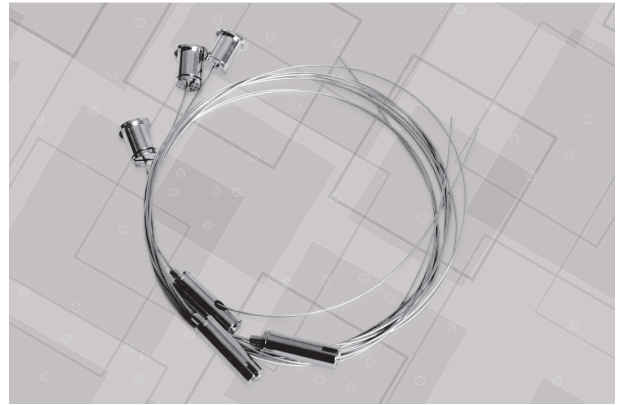

### DIMENSIONS

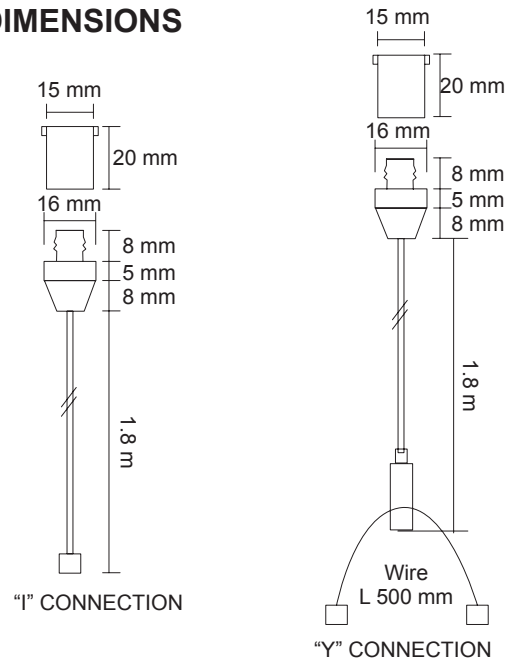

# ALUMINIUM CONCRETE CAN

## S9913

- Suitable fittings: S9003, S9041, S9141, S9046, S9065, S9071, S9048, S9146

Model No.	Internal Ø	Overall Ø	Dimensions Ø x H
S9913	95mm	172mm	172 x 115 mm

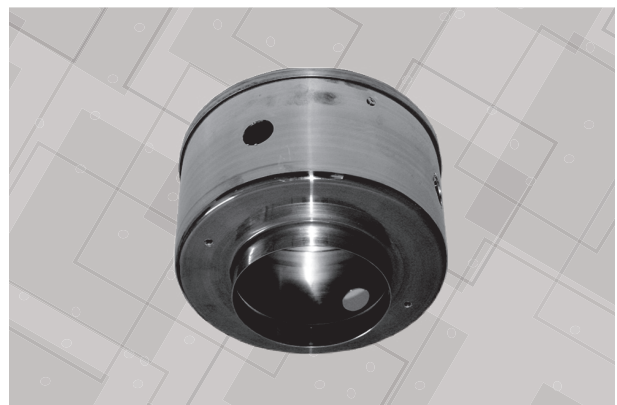

### DIMENSIONS

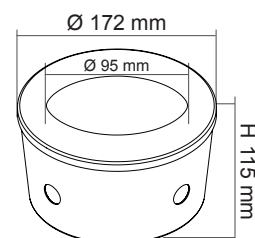



# MICROWAVE MOTION SENSORS

## SMS800 SENSOR

- This can be installed as an option in a range of SAL fittings

Operating voltage	240V
Switched power	1000W incandescent, 300W Fluorescent, 200W LED
Standby power	<1W
Detection distance	Max. 12 m in diameter
Detection range	10 / 25 / 50 / 75 / 100% adjustable
Detection angle	150°
Duration Time	5sec / 30sec / 1min / 5min / 15min / 30min adjustable
Lux threshold	Disable / 2lux / 5lux / 10lux / 30lux / 50lux adjustable
Sensor principle	Microwave motion detector
Material	PC
Microwave power	<1mW
Assembly type	Inbuilt
Mounting height	Max. 6 m
Operating temperature	-30° ~ +70°C
IP rating	IP20



### DIMENSIONS

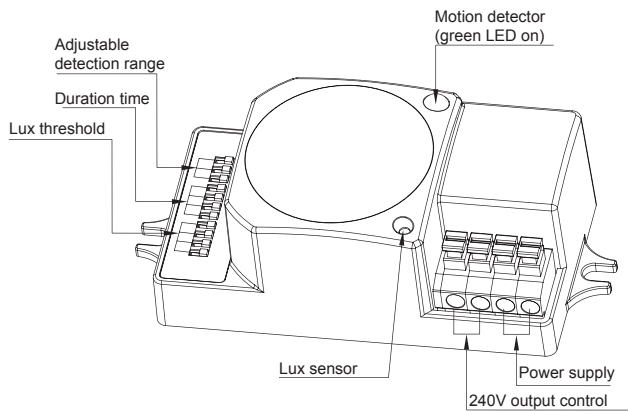
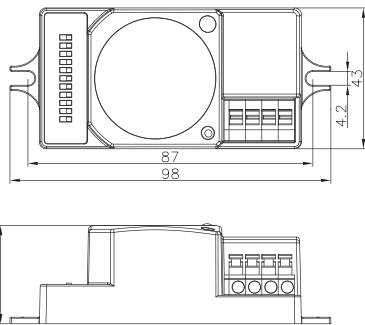

### WIRING DIAGRAM

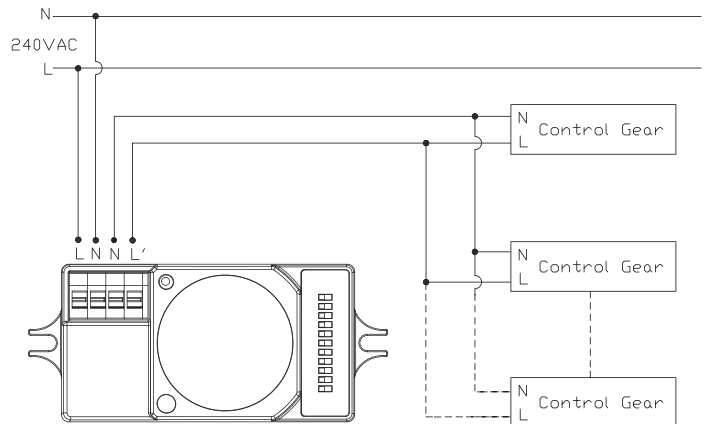

### DETECTION RANGE

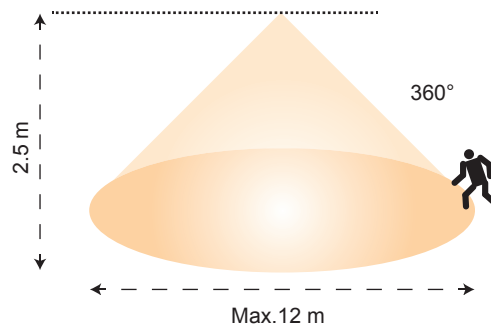

Model No.	Input	Power	Detection Range	IP Rating	Type	Mounting	Colour
SMS800	240V	200W	12 m max. at 2.5 m	IP20	Microwave	Integral	White

# MICROWAVE MOTION SENSORS

## SMS810 SENSOR

- This can be installed as an option in a range of SAL fittings

Operating voltage	240V
Switched power	1000W incandescent, 300W Fluorescent, 200W LED
Standby power	<1W
Detection distance	Max. 16 m in diameter
Detection range	0 ~ 100% adjustable
Detection angle	360°
Duration Time	10 sec to 10 mins adjustable
Lux threshold	Dawn to dusk adjustable
Sensor principle	Microwave motion detector
Material	PC
Microwave power	<1mW
Assembly type	Inbuilt
Mounting height	Max. 8 m
Operating temperature	-15° ~ +70°C
IP rating	IP20

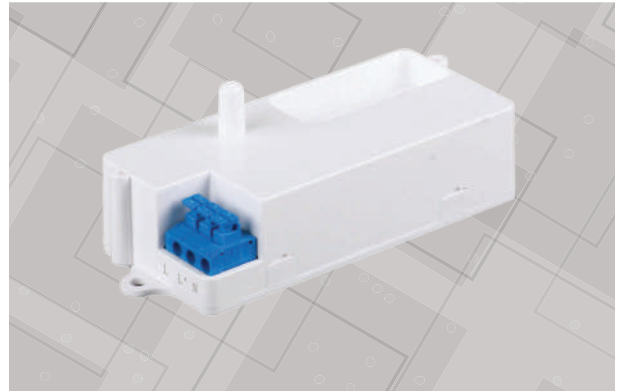

### DIMENSIONS

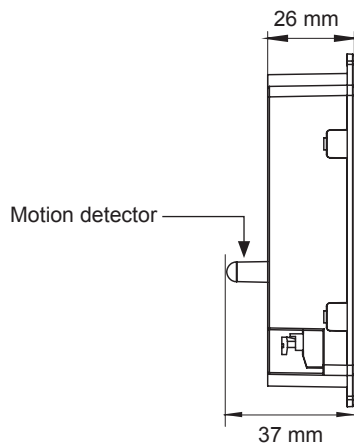
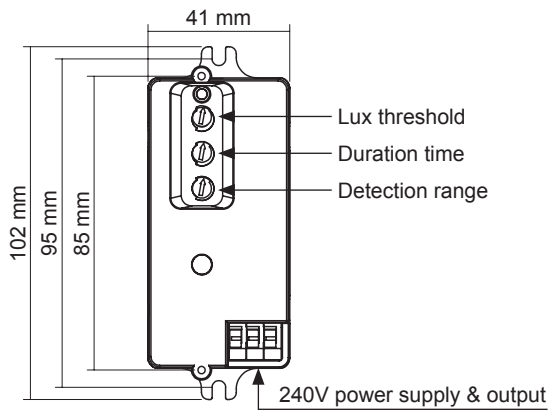

### WIRING DIAGRAM

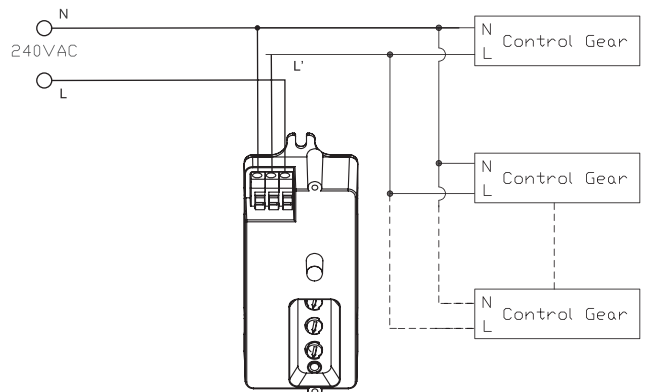

### DETECTION RANGE

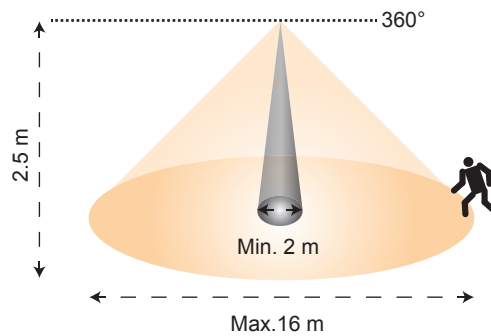

### DETECTION ANGLE

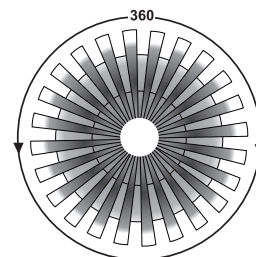

Model No.	Input	Power	Detection Range	IP Rating	Type	Mounting	Colour
SMS810	240V	200W	16 m max. at 2.5 m	IP20	Microwave	Integral	White

# INFRARED SENSORS – SURFACE MOUNTED

## SMS801WF SENSOR



Operating voltage	240V
Switched power	1000W incandescent, 300W Fluorescent, 150W LED
Standby power	<1W
Detection distance	Max. 12 m
Detection angle	Approx. 180° horizontal, 60° vertical
Duration Time	10 sec to 4 mins adjustable
Lux threshold	Dawn to dusk adjustable
Sensor principle	Infrared sensor
Material	PC
Mounting Method	Wall mounted
Mounting height	Max. 6 m
Operating temperature	-10° ~ +40°C
IP rating	IP44



SMS801WF

### DIMENSIONS

SMS801WF

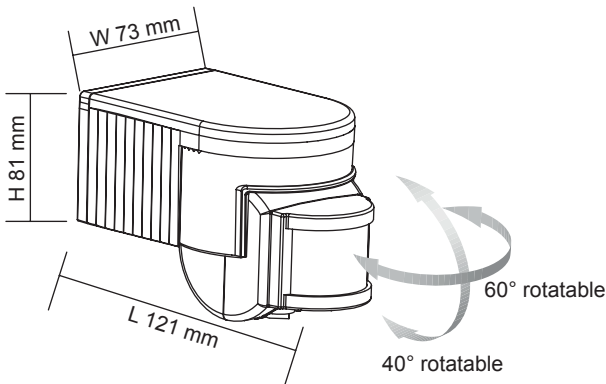

### WIRING DIAGRAM

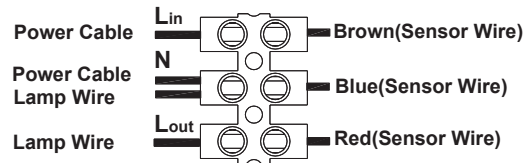
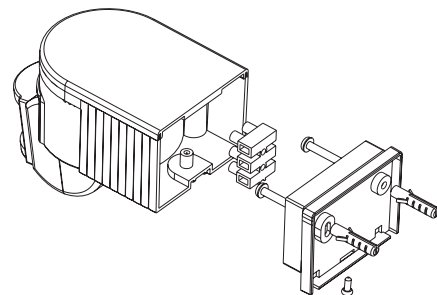

### MANUAL OVERRIDE MODE

- When the lamp(s) is switched on, turn the lamp(s) off/on twice within 3 seconds, the sensor will go to an 8 hour override mode, during which the lamp(s) will stay on. The sensor will then return to normal detection mode
- During override mode, turn the lamp(s) on/off twice within 3 seconds or turn off the lamp(s) for over 10 seconds, the sensor will return to normal detection mode

### DETECTION RANGE

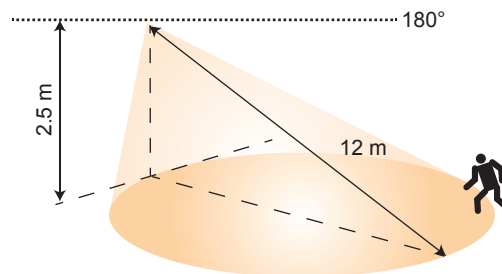

Model No.	Input	Power	Detection Range	IP Rating	Type	Mounting	Colour
SMS801WF	240V	150W	12 m max. at 2.5 m	IP44	Infrared	Wall mount	Black

# INFRARED SENSORS – SURFACE MOUNTED

## SMS802WR SENSOR



Operating voltage	240V
Switched power	1000W incandescent, 300W Fluorescent, 150W LED
Standby power	<1W
Detection distance	Max. 10 m
Detection angle	Approx. 180° horizontal, 60° vertical
Duration Time	10 sec to 4 mins adjustable
Lux threshold	Dawn to dusk adjustable
Sensor principle	Infrared sensor
Material	ABS
Mounting Method	Wall mounted
Mounting height	Max. 5 m
Operating temperature	-10° ~ +40°C
IP rating	IP44



### DIMENSIONS

SMS802WR

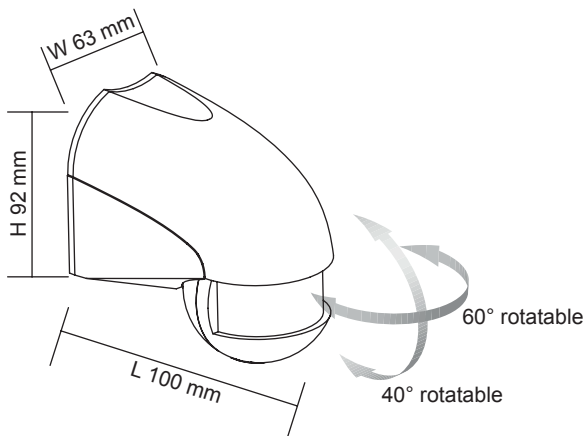

### WIRING DIAGRAM

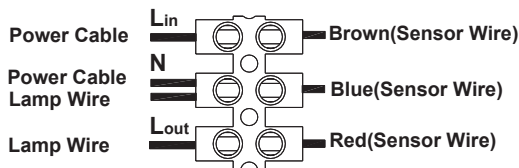
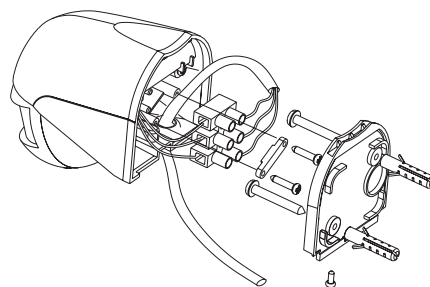

### MANUAL OVERRIDE MODE

- When the lamp(s) is switched on, turn the lamp(s) off/on twice within 3 seconds, the sensor will go to an 8 hour override mode, during which the lamp(s) will stay on. The sensor will then return to normal detection mode
- During override mode, turn the lamp(s) on/off twice within 3 seconds or turn off the lamp(s) for over 10 seconds, the sensor will return to normal detection mode

### DETECTION RANGE

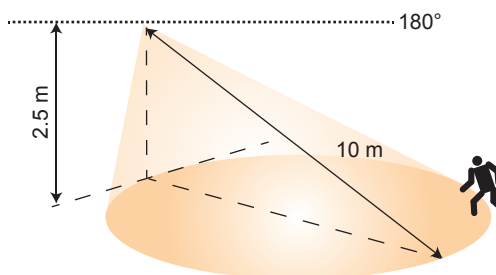

Model No.	Input	Power	Detection Range	IP Rating	Type	Mounting	Colour
SMS802WR	240V	150W	10 m max. at 2.5 m	IP44	Infrared	Wall mount	White



# INFRARED SENSORS – SURFACE / RECESSED OCCUPANCY

## SMS803CD SENSOR

Operating voltage	240V
Switched power	2000W incandescent, 600W Fluorescent, 300W LED
Standby power	<1W
Detection distance	Max. 18 m in diameter for normal detection Max. 6 m in diameter for occupancy detection
Detection angle	360°
Duration Time	10 sec to 40 mins adjustable
Lux threshold	Dawn to dusk adjustable
Sensor principle	3 x Infrared sensor
Material	PC
Mounting Method	Surface mounted or recessed
Mounting height	Max. 9 m
Operating temperature	-10° ~ +40°C
IP rating	IP20



### DIMENSIONS

SMS803CD – surface mounted

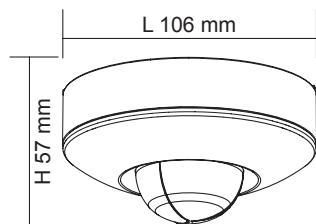

SMS803CD – recessed Ø 92 mm

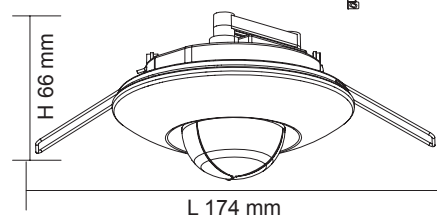

### MANUAL OVERRIDE MODE

- When the lamp(s) is switched on, turn the lamp(s) off/on twice within 3 seconds, the sensor will go to an 8 hour override mode, during which the lamp(s) will stay on. The sensor will then return to normal detection mode
- During override mode, turn the lamp(s) on/off twice within 3 seconds or turn off the lamp(s) for over 10 seconds, the sensor will return to normal detection mode

### DETECTION RANGE

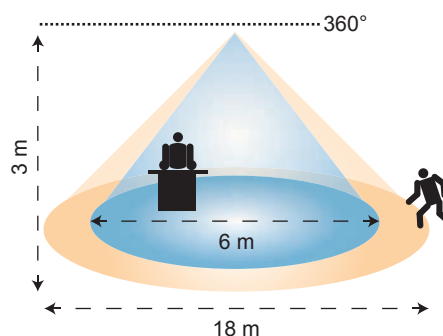

### WIRING DIAGRAM

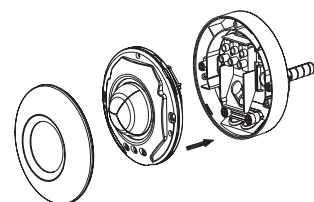
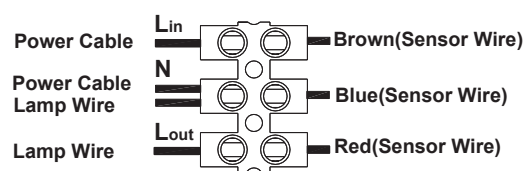

Model No.	Input	Power	Detection Range	IP Rating	Type	Mounting	Colour
SMS803CD	240V	300W	18 m max. at 3 m	IP20	Infrared	Ceiling mount or Recessed	White

# INFRARED SENSORS – RECESSED

## SMS804CR SENSOR

Operating voltage	240V
Switched power	2000W incandescent, 500W Fluorescent, 300W LED
Standby power	<1W
Detection distance	Max. 9 m in diameter
Detection angle	360°
Duration Time	10 sec to 4 mins adjustable
Lux threshold	Dawn to dusk adjustable
Sensor principle	Infrared sensor
Material	PC
Microwave power	<1mw
Mounting Method	Recessed
Mounting height	Max. 4.5 m
Operating temperature	-10° ~ +40°C
IP rating	IP20



### DIMENSIONS

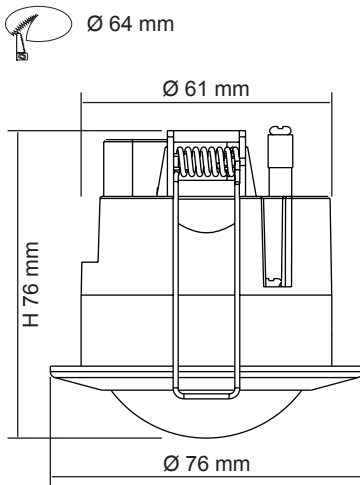

### WIRING DIAGRAM

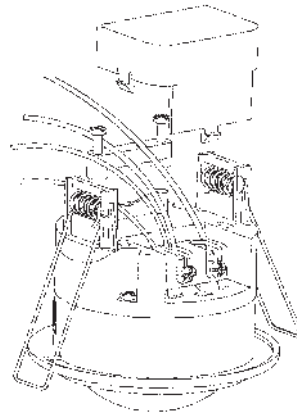
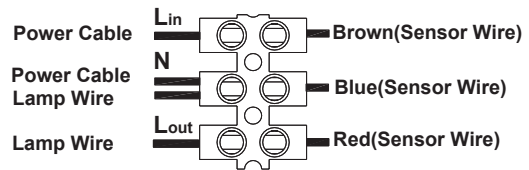

### MANUAL OVERRIDE MODE

- When the lamp(s) is switched on, turn the lamp(s) off/on twice within 3 seconds, the sensor will go to an 8 hour override mode, during which the lamp(s) will stay on. The sensor will then return to normal detection mode
- During override mode, turn the lamp(s) on/off twice within 3 seconds or turn off the lamp(s) for over 10 seconds, the sensor will return to normal detection mode

### DETECTION RANGE

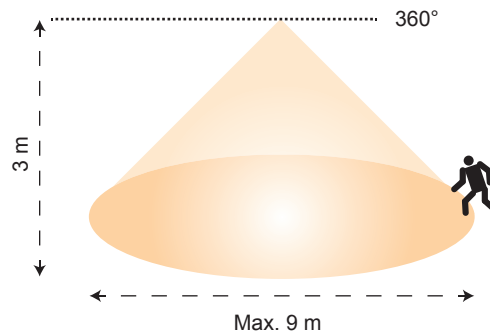

Model No.	Input	Power	Detection Range	IP Rating	Type	Mounting	Colour
SMS804CR	240V	300W	9 m max. at 3 m	IP20	Infrared	Recessed	White



# INFRARED SENSORS – SURFACE MOUNTED

## SMS805CS SENSOR

Operating voltage	240V
Switched power	1600W incandescent, 500W Fluorescent, 200W LED
Standby power	<1W
Detection distance	Max. 12 m in diameter
Detection angle	360°
Duration Time	10 sec to 4 mins adjustable
Lux threshold	Dawn to dusk adjustable
Sensor principle	Infrared sensor
Material	PC
Microwave power	<1mw
Mounting Method	Surface mounted
Mounting height	Max. 6 m
Operating temperature	-10° ~ +40°C
IP rating	IP20



### DIMENSIONS

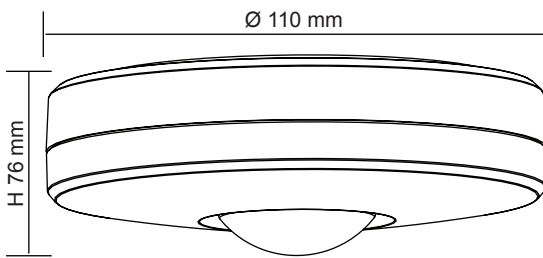

### WIRING DIAGRAM

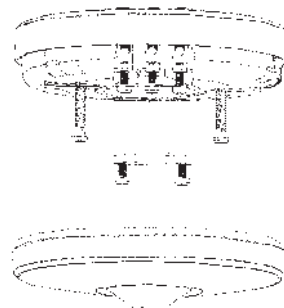
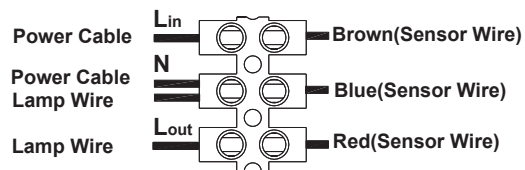

### MANUAL OVERRIDE MODE

- When the lamp(s) is switched on, turn the lamp(s) off/on twice within 3 seconds, the sensor will go to an 8 hour override mode, during which the lamp(s) will stay on. The sensor will then return to normal detection mode
- During override mode, turn the lamp(s) on/off twice within 3 seconds or turn off the lamp(s) for over 10 seconds, the sensor will return to normal detection mode

### DETECTION RANGE

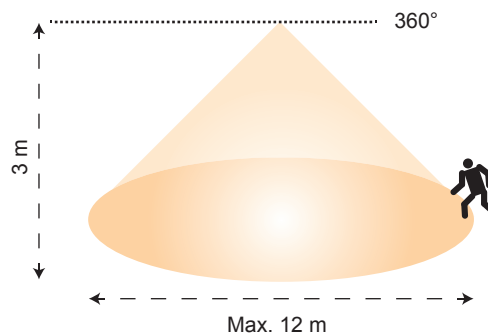

Model No.	Input	Power	Detection Range	IP Rating	Type	Mounting	Colour
SMS805CS	240V	200W	12 m max. at 3 m	IP20	Infrared	Ceiling Mount	White

# MICROWAVE MOTION SENSOR

## SMS731 SENSOR



Sensor type	Microwave motion detector
Operating voltage	240VAC / 50Hz
Switched power	800W
Standby power	<0.8W
Frequency	5.8GHz ±75MHz
Detection distance	Max. 16 m in diameter
Mounting height	Max. 15 m
Detection range	50% / 100% adjustable
Detection angle	360°
Hold Time	5s / 30s / 90s / 3min / 20min / 30min
Lux threshold	50lux / 100lux / 200lux / zero
Stand-by period	5s / 5min / 20min / 30min / 1h / continual
Stand-by dimming level	10% / 20% / 30% / 50%
Material	PC double insulated
Ambient temperature	-20° ~ +60°C
IP rating	IP65

5 core fly lead fitted 0.5 m long

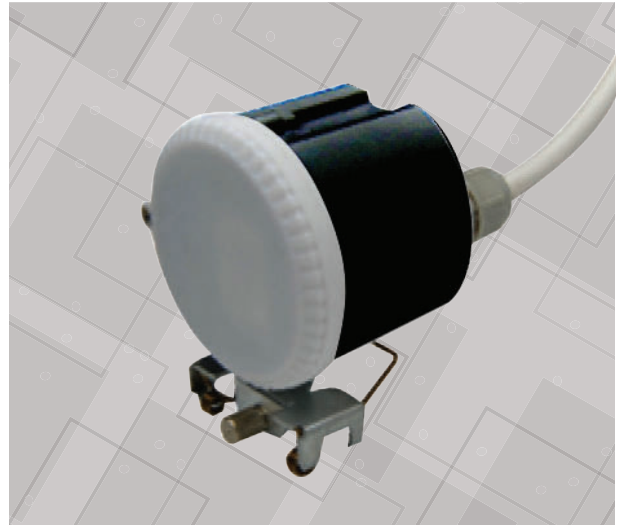

### DIMENSIONS

### WIRING DIAGRAM

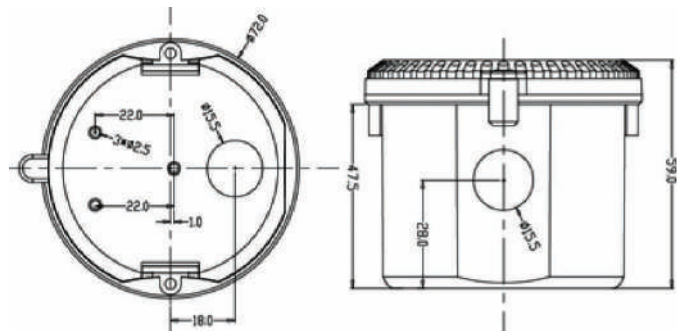
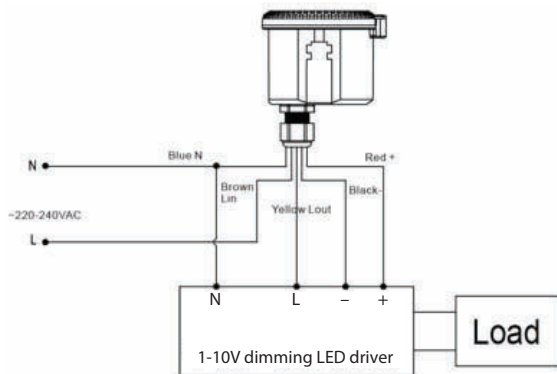

### DETECTION RANGE

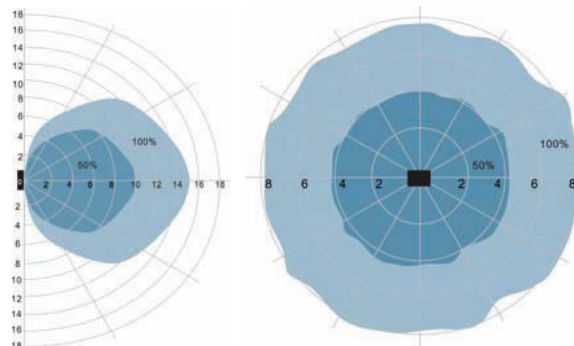

Model No.	Input	Power	Range	IP Rating	Type	Mounting	Colour
SMS731LC	240V	800W	16 m max.	IP65	Microwave	External	Black
SMS731CS	240V	800W	16 m max.	IP65	Microwave	Ceiling Mount	Black
SMS731WS	240V	800W	16 m max.	IP65	Microwave	Wall Mount	Black
SMS731LP	240V	800W	16 m max.	IP65	Microwave	External	Black

# INSTALLATION OPTIONS

## SMS731LC

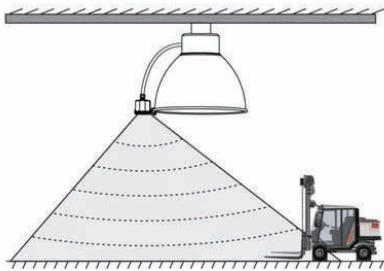

## SMS731CS

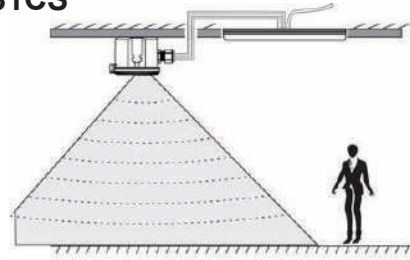

## SMS731WS

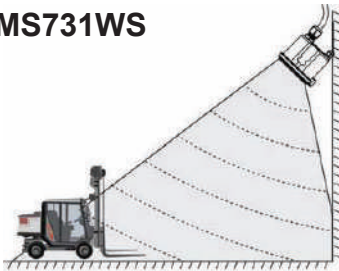

## SMS731LP

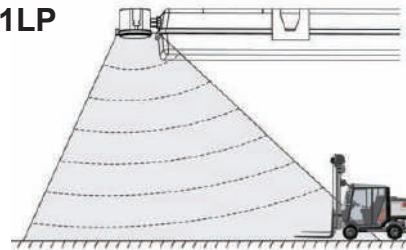

# FUNCTION SETTINGS

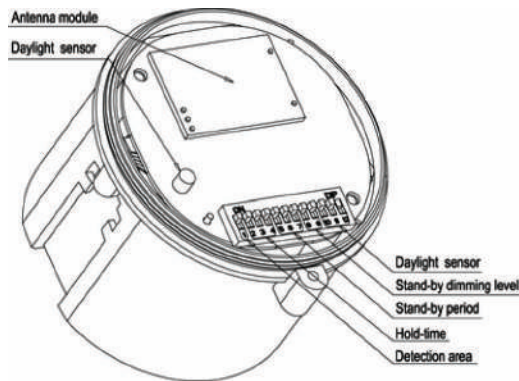

DAYLIGHT SENSOR					HOLD TIME					STAND-BY PERIOD					STAND-BY DIMMING LEVEL				DETECTION AREA		
ON	10	11	12		ON	2	3	4	5s	ON	5	6	7	+∞	ON	8	9	50%	ON	1	100%
I	ON	ON	ON	Disable	II	-	ON	ON	30s	II	-	ON	ON	60min	II	-	ON	30%	I	ON	100%
II	-	ON	-	200lux	III	ON	-	ON	90s	III	ON	-	ON	30min	III	ON	-	20%	II	-	50%
III	ON	-	-	100lux	IV	-	-	ON	3min	IV	-	-	ON	10min	IV	-	-	10%	III	ON	-
IV	-	-	-	50lux	V	ON	ON	-	20min	V	ON	ON	-	5min	V	ON	ON	-	IV	-	-
					VI	-	-	-	30min	VI	-	-	-	5s							

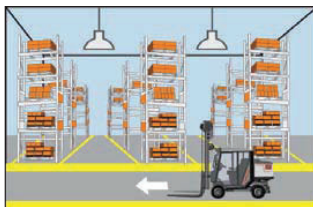

Ambient lux > Set daylight lux  
Light keeps off

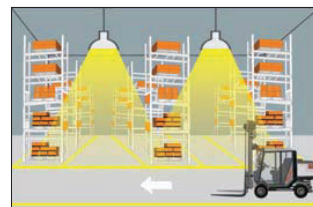

Motion activated  
Light turns on to 100%

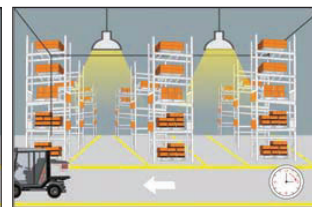

Stand-by (no motion)  
Light dim to standby level

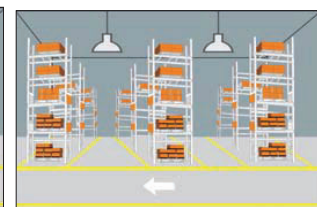

After stand-by (no motion)  
Light: switched off



www.sal.net.au



### Device

Manage devices,  
individual control



### Group

Simultaneous  
control by groups



### Schedule

Schedule your lights

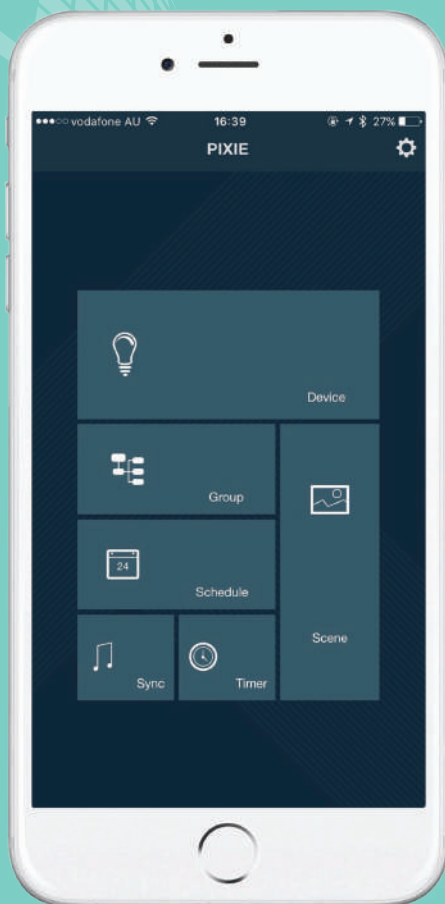

### Scene

Create preset  
lighting scenes



### Timer

Countdown  
turn-off timer



### Sync

PIXIE RGB strip  
flash to music beat

# SMART LIGHTING

## NEW PRODUCTS





# SMART DIMMER

## SDD350BT

### FEATURES: WHEN USED INDEPENDENTLY

- Push on/off
- Hold to dim up or down
- Memory function
- Settable minimum dim level

### FEATURES: WHEN USED IN CONJUNCTION WITH THE “PIXIE” APP



- **TIMER FUNCTION:** set dimmers or dimmer groups to remain on for set time period
- **SCHEDULE FUNCTION:** set dimmers or dimmer groups to turn off, turn on at set times and days of the week. Required brightness levels can also be selected
- **GROUP FUNCTION:** group dimmers together into dimmer groups
- **SCENE FUNCTION:** set up a range of dimming level scenarios (scenes) by individual dimmers, or dimmer groups

### SPECIFICATION

- Fit most branded switch plates. 1, 2 or 3 gang
- Overheating, overload and full short circuit protection
- SMART LED indicator
- Trailing edge phase cutting dimming
- Complies to AS/NZS 60669.2.1
- Retentive terminal screws and loop terminal

### TYPICAL WIRELESS RANGE

- 15 m dependant on installation environment



### DIMENSIONS

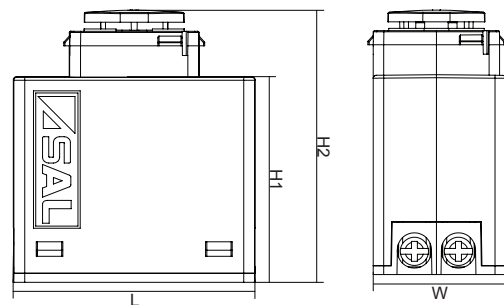

### WIRING DIAGRAM

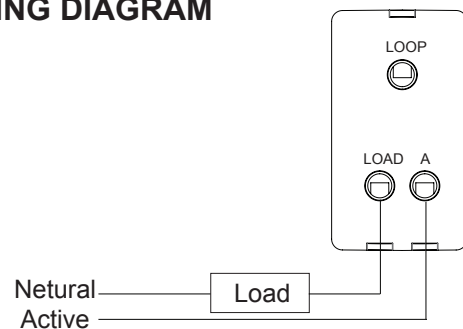

Model No.	Input	Frequency	Max. Load	Min. Load	Dimensions L x H1 x H2 x W	Operating temp.
SDD350BT	220V - 240V	50Hz/60Hz	350W	2W*	40 x 34 x 45 x 22.5 mm	-20~40°C

\*Dimming performance will be affected when the load is less than 2W. (At 25°C)



Go to App store (IOS) or Google Play (Android) to download the free PIXIE app to your smart phone.

IOS: Requires IOS 6.0 or later. Compatible with iPhone, iPad and iPad touch

Android: Requires Android 4.4 or above, devices must support Bluetooth 4.0





# SMART SWITCH

## SWL350BT

### FEATURES: WHEN USED INDEPENDENTLY

- Push on/off

### FEATURES:

#### WHEN USED IN CONJUNCTION WITH THE "PIXIE" APP



- **TIMER FUNCTION:** set switches or switch groups to remain on for set time
- **SCHEDULE FUNCTION:** set switches or switch groups to turn on and off at required times and days of the week
- **GROUP FUNCTION:** group switches together into switch groups
- **SCENE FUNCTION:** set up a range of scenarios (scenes) by individual switches or switch groups



### SPECIFICATION

- Fit most branded switch plates. 1, 2 or 3 gang
- Overheating, overload and full short circuit protection
- SMART LED indicator
- Complies to AS/NZS 60669.2.1
- Retentive terminal screws and loop terminal

### TYPICAL WIRELESS RANGE

- 15 m dependant on installation environment

### DIMENSIONS

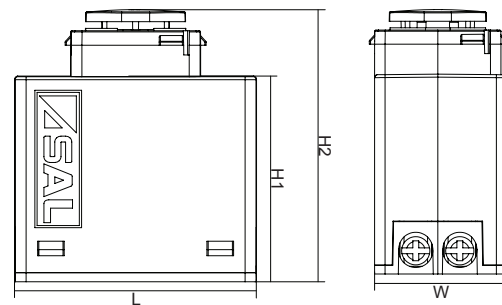

### WIRING DIAGRAM

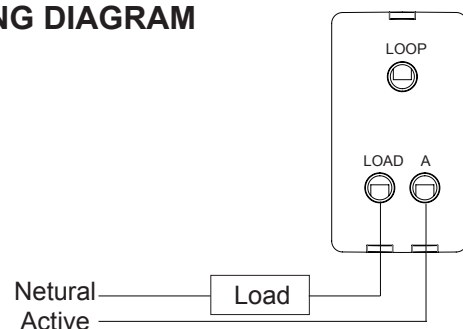

Model No.	Input	Frequency	Max. Load	Min. Load	Dimensions L x H1 x H2 x W	Operating temp.
SWL350BT	220V - 240V	50Hz/60Hz	350W	13W	40 x 34 x 45 x 22.5 mm	-20~40°C



Go to App store (IOS) or Google Play (Android) to download the free PIXIE app to your smart phone.

IOS: Requires IOS 6.0 or later. Compatible with iPhone, iPad and iPad touch

Android: Requires Android 4.4 or above, devices must support Bluetooth 4.0



# SMART LED STRIP KIT

## FLP12V/SBT FLEXI SMART

### FEATURES

- Dimmable controlled by included remote, or PIXIE app
- Dimming memory function
- High performance, stable, even light output
- Pre wired for easy installation, plug-in & ready to use
- Cuttable every 50mm
- 2M and 5M packs
- **NOTE:** Heatsink required

### ADDITIONAL FUNCTIONS WHEN USED WITH PIXIE APP:



- **TIMER FUNCTION:** Set strips or strip groups to remain on for set period and set a countdown timer (1 min. to 24 hours) until strips or strip groups turn off
- **SCHEDULE FUNCTION:** Set strips or strip groups specific time to turn on and off. Required brightness levels can also be selected
- **GROUP FUNCTION:** Group strips together into strip groups and control as one
- **SCENE FUNCTION:** Set a range of scenarios (scenes) by individual strips or strip groups and activate with one touch



### CONSTRUCTION

- Kit includes weatherproof strip, driver with flex and plug, controller and remote control
- High performance SMD LED chips
- Self-adhesive backing

### IP RATING

- IP44 (strip only)

### LED CHANNEL OPTIONS

SLT1000, SLT3000, SLT3010, SLT3020, SLT3030, SLT3040, SLT3050, SLT4050, SLT5000

### DIMENSIONS

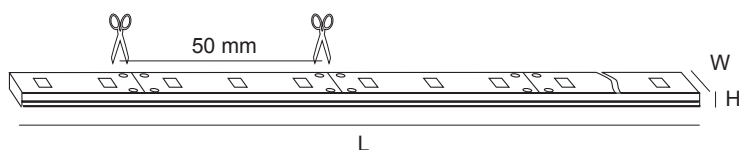

Model No.	Input	Power	Lumen	CCT	Beam Angle	Cuttable Length	Dimensions L x W x H	LED Qty.
FLP12V2M/NDL/SBT	240V	6W/m	350lm/m	5000K	115°	50 mm	2000 x 8 x 2.5 mm	60ea/m
FLP12V2M/WW/SBT	240V	6W/m	350lm/m	3000K	115°	50 mm	2000 x 8 x 2.5 mm	60ea/m
FLP12V5M/NDL/SBT	240V	6W/m	350lm/m	5000K	115°	50 mm	5000 x 8 x 2.5 mm	60ea/m
FLP12V5M/WW/SBT	240V	6W/m	350lm/m	3000K	115°	50 mm	5000 x 8 x 2.5 mm	60ea/m



Go to App store (IOS) or Google Play (Android) to download the free PIXIE app to your smart phone.

IOS: Requires IOS 6.0 or later. Compatible with iPhone, iPad and iPad touch

Android: Requires Android 4.4 or above, devices must support Bluetooth 4.0



www.sal.net.au

# SMART LED STRIP KIT

## FLP12V/RGBBT FLEXI SMART

### FEATURES

- Colour and brightness controlled by included remote, or PIXIE app
- Four different flashing modes
- Dimming memory function
- High performance, stable, even light output
- Pre wired for easy installation, plug-in & ready to use
- Cuttable every 100mm
- 2M and 5M packs
- **NOTE:** Heatsink required

### ADDITIONAL FUNCTIONS WHEN USED WITH PIXIE APP:

PIXIE

- **SYNC FUNCTION:** The synchronisation function matches the light transitions to the rhythm of the music
- **TIMER FUNCTION:** Set strips or strip groups to remain on for set period and set a countdown timer (1 min. to 24 hours) until strips or strip groups turn off
- **SCHEDULE FUNCTION:** Set strips or strip groups specific time to turn on and off. Required brightness levels can also be selected
- **GROUP FUNCTION:** Group strips together into strip groups and control as one
- **SCENE FUNCTION:** Set a range of scenarios (scenes) by individual strips or strip groups and activate with one touch



### CONSTRUCTION

- Kit includes weatherproof strip, driver with flex and plug, RGB controller and RGB remote control
- High performance SMD LED chips
- Self-adhesive backing

### IP RATING

- IP44 (strip only)

### LED CHANNEL OPTIONS

SLT1000, SLT3000, SLT3010, SLT3020, SLT3030, SLT3040, SLT3050, SLT4050, SLT5000

### DIMENSIONS

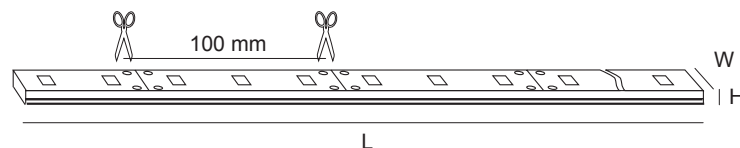

Model No.	Input	Power	Colour	Beam Angle	Cuttable Length	Dimensions L x W x H	LED Qty.
FLP12V2M/RGBBT	240V	5.4W/m	RGB	115°	100 mm	2000 x 10 x 3 mm	30ea/m
FLP12V5M/RGBBT	240V	5.4W/m	RGB	115°	100 mm	5000 x 10 x 3 mm	30ea/m



Go to App store (IOS) or Google Play (Android) to download the free PIXIE app to your smart phone.

IOS: Requires IOS 6.0 or later. Compatible with iPhone, iPad and iPad touch

Android: Requires Android 4.4 or above, devices must support Bluetooth 4.0



www.sal.net.au

# INDEX

2S9000	291	FLC10CS	170
3S9000	291	FLC10SS	170
3S9000/2	291	FLC 400 RGB	170
AR111/700WW LED	273	FLC 400 S	170
AR111/1700CW LED	273	FLH2420 CW	168
AR111/1700WW LED	273	FLH2420 DL	168
AR111/3500WW	273	FLH2420 WW	168
CONVERTER M/LV	291	FLP12V2M/NDL/S	164
DIM40W/12V	283	FLP12V2M/NDL/GBT	306
DIM100W/12V	283	FLP12V2M/RGBBT	307
DIM100W/24V	283	FLP12V2M/WW/S	164
DIM110/150W/12V	283	FLP12V2M/WW/GBT	306
DIM110/150W/24V	283	FLP12V5M/NDL/S	164
DIM200W/12V	283	FLP12V5M/NDL/GBT	306
DIM200W/24V	283	FLP12V5M/RGB	165
DIM350MA/12W	284	FLP12V5M/RGBBT	307
DIM350MA/18W	284	FLP12V5M/WW/S	164
DIM500MA/18W	284	FLP12V5M/WW/GBT	306
DIM700MA/18W	284	G4L15DL	278
DIM700MA/30W	284	G4L15WW	278
DIM700MA/36W	284	G4L25DL	278
DIM1400MA/36W	284	G4L25WW	278
ESS101	289	G9L3D/ DL	279
ESS102	289	G9L3D/ WW	279
FL1206BU/S	163	GU10L350CW	42
FL1206GN/S	163	GU10L350CW	275
FL1206RD/S	163	GU10L350DL	42
FL1209CW/S	162	GU10L350DL	275
FL1209CW/SR	162	GU10L350WW	42
FL1209DL/S	162	GU10L350WW	275
FL1209DL/SR	162	GU10L550CW	42
FL1209WW/S	162	GU10L550CW	275
FL1209WW/SR	162	GU10L550DL	42
FL2406BU/R05	166	GU10L550DL	275
FL2406CW/SS10	167	GU10L550WW	42
FL2406DL/SS10	167	GU10L550WW	275
FL2406NDL/R05	166	GU10LA750CW	42
FL2406WW/R05	166	GU10LA750CW	275
FL2406WW/SS10	167	GU10LA750DL	42
FL2412CW/SS10	167	GU10LA750DL	275
FL2412DL/SS10	167	GU10LA750WW	42
FL2412WW/SS10	167	GU10LA750WW	275
FL2415RGB/S	169	GU10LR750CW	42
FLC05CS	170	GU10LR750CW	275

# INDEX

GU10LR750DL	42	LG5/27B22D/C	258
GU10LR750DL	275	LG5/27E27D	259
GU10LR750WW	42	LG5/27E27D/C	258
GU10LR750WW	275	LG5/50B22D	259
GX53/450 CW	279	LG5/50B22D/C	258
GX53/450 DL	279	LG5/50E27D	259
GX53/450 WW	279	LG5/50E27D/C	258
L21021 WW WH	44	LG9/27B22D	259
L21022 WW WH	44	LG9/27B22D/C	258
LCA27B15D	261	LG9/27E27D	259
LCA27B15D/C	260	LG9/27E27D/C	258
LCA27B22D	261	LG9/50B22D	259
LCA27B22D/C	260	LG9/50B22D/C	258
LCA27E14D	261	LG9/50E27D	259
LCA27E14D/C	260	LG9/50E27D/C	258
LCA27E27D	261	LG95/27B22D/C	266
LCA27E27D/C	260	LG95/27E27D/C	266
LCA50B15D	261	LG95/50B22D/C	266
LCA50B15D/C	260	LG95/50E27D/C	266
LCA50B22D	261	LG95/830B22	267
LCA50B22D/C	260	LG95/830E27	267
LCA50E14D	261	LG95/860B22	267
LCA50E14D/C	260	LG95/860E27	267
LCA50E27D	261	LG125/27B22D/C	266
LCA50E27D/C	260	LG125/27E27D/C	266
LCT21TC	281	LG125/50B22D/C	266
LCT30TC	281	LG125/50E27D/C	266
LFR27B15D	263	LG125/830B22	267
LFR27B15D/C	262	LG125/830E27	267
LFR27B22D	263	LG125/860B22	267
LFR27B22D/C	262	LG125/860E27	267
LFR27E14D	263	LG125FD822E27	265
LFR27E14D/C	262	LGS4/830B22	268
LFR27E27D	263	LGS4/830E27	268
LFR27E27D/C	262	LGS4/840B22	268
LFR50B15D	263	LGS4/840E27	268
LFR50B15D/C	262	LGS4/860B22	268
LFR50B22D	263	LGS4/860E27	268
LFR50B22D/C	262	LGS8/830B22	268
LFR50E14D	263	LGS8/830E27	268
LFR50E14D/C	262	LGS8/840B22	268
LFR50E27D	263	LGS8/840E27	268
LFR50E27D/C	262	LGS8/860B22	268
LG5/27B22D	259	LGS8/860E27	268

# INDEX

LGS10/830B22	268	LT407/65B22	270
LGS10/830E27	268	LT407/65E14	270
LGS10/840B22	268	LT407/65E27	270
LGS10/840E27	268	LT409/27B22	271
LGS10/860B22	268	LT409/27B22D	271
LGS10/860E27	268	LT409/27E27	271
LGS14/830B22D	269	LT409/27E27D	271
LGS14/830E27D	269	LT409/40B22	271
LGS14/840B22D	269	LT409/40B22D	271
LGS14/840E27D	269	LT409/40E27	271
LGS14/860B22D	269	LT409/40E27D	271
LGS14/860E27D	269	LT409/65B22	271
LP25F830E14	264	LT409/65B22D	271
LPAR20DL	277	LT409/65E27	271
LPAR20WW	277	LT409/65E27D	271
LPAR30DL	277	LT8903 DIM	174
LPAR30WW	277	LT8903 RGB	174
LPAR38DL	277	LT8904 DIM/RP	176
LPAR38WW	277	LT8904 RGB/RP	176
LR50DL	276	LT8905 DIM	178
LR50WW	276	LT8905 RGB	178
LR63DL	276	MINI60	40
LR63WW	276	MINI60	41
LR80DL	276	MINI60	285
LR80WW	276	MINI/P60	40
LR95DL	276	MINI/P60	41
LR95WW	276	MINI/P60	285
LST21FD822E27	265	MR16 5W DL	40
LT8/60CW	272	MR16 5W DL	41
LT8/60DL	272	MR16 5W DL	274
LT8/60WW	272	MR16 5W WW	40
LT8/120CW	272	MR16 5W WW	41
LT8/120DL	272	MR16 5W WW	274
LT8/120WW	272	MR16/7W/DL	40
LT25F830E14	264	MR16/7W/DL	41
LT407/27B15	270	MR16/7W/DL	274
LT407/27B22	270	MR16/7W/WW	40
LT407/27E14	270	MR16/7W/WW	41
LT407/27E27	270	MR16/7W/WW	274
LT407/40B15	270	MR16DIM9W/DL	40
LT407/40B22	270	MR16DIM9W/DL	41
LT407/40E14	270	MR16DIM9W/DL	274
LT407/40E27	270	MR16DIM9W/WW	40
LT407/65B15	270	MR16DIM9W/WW	41



# INDEX

MR16DIM9W/WW	274	S9008CW	38
PLUTO 15/24V	282	S9008DL	38
PLUTO 30/12V	282	S9008WW	38
PLUTO 30/24V	282	S9009CW	39
PLUTO 50/12V	282	S9009DL	39
PLUTO 50/24V	282	S9009WW	39
PLUTO 100/12V	282	S9010CW	39
PLUTO 100/24V	282	S9010DL	39
PLUTO 200/12V	282	S9010WW	39
PLUTO 200/24V	282	S9015/80CW/BK	65
PLUTO EGL 12V/6W	282	S9015/80DL/BK	65
PLUTO EGL 12V/15W	282	S9015/80GU10/BK*	65
S306FM	137	S9015/80WW/BK	65
S312FM	137	S9015/150CW/BK	65
S606FM	137	S9015/150DL/BK	65
S612FM	137	S9015/150WW/BK	65
S9000LH	291	S9016/2CW/BK	67
S9001BK	40	S9016/2DL/BK	67
S9001SC	40	S9016/2WW/BK	67
S9001 SCH GU10	42	S9016/3CW/BK	67
S9001SN	40	S9016/3DL/BK	67
S9001WH	40	S9016/3WW/BK	67
S9001 WH GU10	42	S9016CW/BK	67
S9002CH	40	S9016DL/BK	67
S9002GL	40	S9016WW/BK	67
S9002SC	40	S9041 CW WH	21
S9002SN	40	S9041 DL WH	21
S9002WH	40	S9041SM/C CW WH	24
S9003BK	40	S9041SM/C DL WH	24
S9003SC	40	S9041SM/C TC WH	24
S9003 SCH GU10	42	S9041SM/C WW WH	24
S9003SN	40	S9041 TC S SN	23
S9003WH	40	S9041 TC S WH	23
S9003 WH GU10	42	S9041 TC WH	22
S9004CH	40	S9041 WW WH	21
S9004SC	40	S9045 DL SN	30
S9004SN	40	S9045 DL WH	30
S9004WH	40	S9045SM/C DL WH	33
S9006CW	38	S9045SM/C WW WH	33
S9006DL	38	S9045 WW SN	30
S9006WW	38	S9045 WW WH	30
S9007CW	38	S9046 DL SN	31
S9007DL	38	S9046 DL WH	31
S9007WW	38	S9046SM/C DL WH	34

# INDEX

S9046SM/C WW WH	34	S9105WW/WH	100
S9046 WW SN	31	S9140SM/C TC WH	19
S9046 WW WH	31	S9140TC/WH	18
S9048 DL SN	32	S9141TC/WH	20
S9048 DL WH	32	S9141TC/WH/K12	20
S9048SM/C DL WH	34	S9145CW/WH	35
S9048SM/C WW WH	34	S9145DL/WH	35
S9048 WW SN	32	S9145WW/WH	35
S9048 WW WH	32	S9146CW/WH	35
S9053 CP	36	S9146DL/WH	35
S9053 CP	40	S9146WW/WH	35
S9053 CP	41	S9311 SN	104
S9053 DP	36	S9311 WH	104
S9053 DP	40	S9316/8 BOX	105
S9053 DP	41	S9316/8 BOX	106
S9053 WP	36	S9316 ALU	105
S9053 WP	40	S9316 WH	105
S9053 WP	41	S9317 ALU	105
S9064TC WH	27	S9317 WH	105
S9065CW WH	28	S9318 AS	106
S9065DL WH	28	S9318 MW	106
S9065TC WH	27	S9319 AS	107
S9065WW WH	28	S9319 MW	107
S9066TC WH	27	S9320	101
S9071TC SL	48	S9327	102
S9071TC WH	48	S9328	102
S9072TC SL	48	S9337	227
S9072TC WH	48	S9338/3W/30 DL	237
S9073TC SL	48	S9338/3W/30 WW	237
S9073TC WH	48	S9341CW	238
S9074TC WH	49	S9341WW	238
S9075TC WH	49	S9342CW	239
S9076TC WH	49	S9342WW	239
S9105DL/SN	100	S9343CW	239
S9105DL SR/SN	100	S9343WW	239
S9105DL SR/WH	100	S9344CW	239
S9105DL ST/SN	100	S9344WW	239
S9105DL ST/WH	100	S9345CW	239
S9105DL/WH	100	S9345WW	239
S9105WW/SN	100	S9346CW	241
S9105WW SR/SN	100	S9346WW	241
S9105WW SR/WH	100	S9347CW	241
S9105WW ST/SN	100	S9347WW	241
S9105WW ST/WH	100	S9348CW	241

# INDEX

S9348WW	241	S9523SM/C TC WH	47
S9349CW	241	S9523TC SL	46
S9349WW	241	S9523TC WH	46
S9351CW	241	S9525/92CW/WH	57
S9351WW	241	S9525/92DL/WH	57
S9352CW	241	S9525/92WW/WH	57
S9352WW	241	S9525/125CW/WH	57
S9353CW/BK	226	S9525/125DL/WH	57
S9353CW/CB	226	S9525/125WW/WH	57
S9353WW/BK	226	S9525/145CW/WH	57
S9353WW/CB	226	S9525/145DL/WH	57
S9354CW/BK	226	S9525/145WW/WH	57
S9354CW/CB	226	S9530/2X700 SL	53
S9354WW/BK	226	S9530/2X700 WH	53
S9354WW/CB	226	S9530/2X1700 SL	53
S9356/160WW/WH	103	S9530/2X1700 WH	53
S9356/610WW/WH	103	S9530/2X3500 SL	53
S9401CH	41	S9530/2X3500 WH	53
S9401GL	41	S9530/3X700 SL	53
S9401SC	41	S9530/3X700 WH	53
S9401SN	41	S9530/3X1700 SL	53
S9404SN	41	S9530/3X1700 WH	53
S9413CH	41	S9530/3X3500 SL	53
S9413GL	41	S9530/3X3500 WH	53
S9413SC	41	S9530/700 SL	53
S9413WH	41	S9530/700 WH	53
S9511/LED/SL	108	S9530/1700 SL	53
S9511/LED/WH	108	S9530/1700 WH	53
S9512/LED/SL	108	S9530/3500 SL	53
S9512/LED/WH	108	S9530/3500 WH	53
S9514TC SL	45	S9545CW/WH	54
S9514TC WH	45	S9545DL/WH	54
S9515 LED SN	109	S9545WW/WH	54
S9515 LED WH	109	S9601/112/15CW	59
S9520/2X700 SL	53	S9601/140/25CW	59
S9520/2X1700 SL	53	S9601/140/34CW	59
S9520/3X700 SL	53	S9601/188/42CW	59
S9520/3X700 WH	53	S9601/188/49CW	59
S9520/3X1700 SL	53	S9603/80/15CW	64
S9520/3X1700 WH	53	S9603/80/20CW	64
S9520/700 SL	53	S9603/110/25CW	64
S9520/1700 SL	53	S9603/110/34CW	64
S9522TC SL	46	S9603/150/42CW	64
S9522TC WH	46	S9603/150/49CW	64

# INDEX

S9603/150/62CW	64	S9704/414 FRAME	135
S9651/70CW/WH7W	63	S9714/306AS/CW	134
S9651/70CW/WH10W	63	S9714/306AS/TC	134
S9651/125CW/WH20W	63	S9714/306 CW	131
S9651/125CW/WH30W	63	S9714/306EM	131
S9651/175CW/WH35W	63	S9714/306TC	131
S9651/175CW/WH50W	63	S9714/312AS/CW	134
S9656CW BK	51	S9714/312AS/DL	134
S9656CW BK SQ	51	S9714/312AS/TC	134
S9656CW WH	51	S9714/312CR/CW	136
S9656CW WH RG	51	S9714/312CR/DL	136
S9656CW WH SQ	51	S9714/312CR/TC	136
S9656CW WH SQG	51	S9714/312 CW	131
S9656WW BK	51	S9714/312 DL	131
S9656WW BK SQ	51	S9714/312EM	131
S9656WW WH	51	S9714/312TC	131
S9656WW WH RG	51	S9714/606CR/CW	136
S9656WW WH SQ	51	S9714/606CR/DL	136
S9656WW WH SQG	51	S9714/606CR/TC	136
S9658CW BK	51	S9714/606 CW	131
S9658CW BK SQ	51	S9714/606 DL	131
S9658CW WH	51	S9714/606EM	131
S9658CW WH RG	51	S9714/606TC	131
S9658CW WH SQ	51	S9714/612 CW	131
S9658CW WH SQG	51	S9714/612EM	131
S9658WW BK	51	S9714/612TC	131
S9658WW BK SQ	51	S9714HC/312AS/CW	134
S9658WW WH	51	S9714HC/312CR/CW	136
S9658WW WH RG	51	S9714HC/312CW	133
S9658WW WH SQ	51	S9714HC/606CR/CW	136
S9658WW WH SQG	51	S9714HC/606CW	133
S9681/85CW	58	S9714HC/612CW	133
S9681/115CW	58	S9714HO/312AS/TC	134
S9691/85/7CW	61	S9714HO/312CR/TC	136
S9691/85/10CW	61	S9714HO/312TC	132
S9691/110/15CW	61	S9714HO/606CR/TC	136
S9691/135/34CW	61	S9714HO/606TC	132
S9691/135/42CW	61	S9714SP6	138
S9691/135/49CW	61	S9724/306CW	139
S9691/160/42CW	61	S9724/306DL	139
S9691/160/49CW	61	S9724/306WW	139
S9704/214 FRAME	135	S9724/312CW	139
S9704/228 FRAME	135	S9724/312DL	139
S9704/328 FRAME	135	S9724/312WW	139

# INDEX

S9724/606CW	139	SE7008 BK	225
S9724/606DL	139	SE7008 SLS	225
S9724/606WW	139	SE7009 BK	225
S9725/312CW	141	SE7009 SLS	225
S9725/606CW	141	SE7013 BK	198
S9733L/206TC	121	SE7013 SLS	198
S9733L/212CW	121	SE7016 BK	225
S9733L/212DL	121	SE7016 SLS	225
S9733L/212TC	121	SE7017 BK	225
S9733L/215TC	121	SE7017 SLS	225
S9734/306L/CW	140	SE7018 BK	225
S9734/312L/CW	140	SE7018 SLS	225
S9734/606L/CW	140	SE7019 BK	225
S9734/612L/CW	140	SE7019 SLS	225
S9775CW	126	SE7060NDL/BK	186
S9776/40CW	125	SE7061/500 BK	230
S9776/80CW	125	SE7061/500 LV BK	230
S9841SM/C WH	26	SE7061/800 BK	230
S9841WH	25	SE7061/800 LV BK	230
S9841WH/K4/1	25	SE7062 BK	215
S9865WH	29	SE7062 CB	215
S9901BK	290	SE7071/15DL/BK	189
S9901SN	290	SE7071/15DL/SL	189
S9901WH	290	SE7071/15DL/WH	189
S9902F/120-S9053 CP	43	SE7071/15WW/BK	189
S9902F/120-S9053 DP	43	SE7071/15WW/SL	189
S9902F/120-S9053 WP	43	SE7071/15WW/WH	189
S9903BK	290	SE7071/30DL/BK	189
S9903SN	290	SE7071/30DL/SL	189
S9903WH	290	SE7071/30DL/WH	189
S9913	292	SE7071/30WW/BK	189
S9922	290	SE7071/30WW/SL	189
S9923	290	SE7071/30WW/WH	189
S9931WH	290	SE7071/50DL/BK	189
S9933WH	290	SE7071/50DL/SL	189
SDA450	288	SE7071/50DL/WH	189
SDD350BT	304	SE7071/50WW/BK	189
SDD350TCM	288	SE7071/50WW/SL	189
SDD350TCS	288	SE7071/50WW/WH	189
SDF30	288	SE7073NDL/RD	205
SE7006 BK	225	SE7073NDL/YW	205
SE7006 SLS	225	SE7080/1 DL BK	184
SE7007 BK	225	SE7080/1 WW BK	184
SE7007 SLS	225	SE7080/2 DL BK	184

# INDEX

SE7080/2 DL SL	184	SE7099/150WW/BK	193
SE7080/2 WW BK	184	SE7099/150WW/SL	193
SE7080/2 WW SL	184	SE7099/200DL/BK	193
SE7081L BK DL	202	SE7099/200DL/SL	193
SE7081L BK WW	202	SE7099/200WW/BK	193
SE7081L SL DL	202	SE7099/200WW/SL	193
SE7081L SL WW	202	SE7099AMB/BK5	193
SE7082L BK DL	202	SE7099AMB/BK5	195
SE7082L BK WW	202	SE7099AMB/BK8	193
SE7082L SL DL	202	SE7099AMB/BK8	195
SE7082L SL WW	202	SE7099AMB/BK10	193
SE7083L BK DL	203	SE7099AMB/BK10	195
SE7083L BK WW	203	SE7099PMB/BK	193
SE7083L/EM/DL/BK	203	SE7099PMB/BK	195
SE7083L/EM/DL/SL	203	SE7099SPK/BK	193
SE7083L/EM/WW/BK	203	SE7099SPK/BK	195
SE7083L/EM/WW/SL	203	SE7100/6018	253
SE7083L SL DL	203	SE7100/6030	253
SE7083L SL WW	203	SE7100/6055	253
SE7084L BK DL	203	SE7100/6155	253
SE7084L BK WW	203	SE7100/9018	253
SE7084L/EM/DL/BK	203	SE7100/9030	253
SE7084L/EM/DL/SL	203	SE7100/9055	253
SE7084L/EM/WW/BK	203	SE7100/9155	253
SE7084L/EM/WW/SL	203	SE7102 BK/LGLS	231
SE7084L SL DL	203	SE7102 SL/LGLS	231
SE7084L SL WW	203	SE7103BK/LGLS	232
SE7085	229	SE7104BK/LGLS	232
SE7086/55	229	SE7105BK/LGLS	232
SE7086/100	229	SE7106BK/LGLS	232
SE7087L	204	SE7121BK GU10	212
SE7088 BK	221	SE7121SL GU10	212
SE7088 CB	221	SE7121SLS GU10	212
SE7089BK	204	SE7122BK GU10	212
SE7099/50DL/BK	192	SE7122SL GU10	212
SE7099/50DL/SL	192	SE7122SLS GU10	212
SE7099/50WW/BK	192	SE7123BK GU10	212
SE7099/50WW/SL	192	SE7123SL GU10	212
SE7099/75DL/BK	192	SE7123SLS GU10	212
SE7099/75DL/SL	192	SE7131BK GU10	214
SE7099/75WW/BK	192	SE7131CB GU10	214
SE7099/75WW/SL	192	SE7132BK GU10	214
SE7099/150DL/BK	193	SE7132CB GU10	214
SE7099/150DL/SL	193	SE7133BK GU10	213



# INDEX

SE7133SL GU10	213	SE7148CW/CB	220
SE7134BK GU10	213	SE7148NB/CW BK	220
SE7134SL GU10	213	SE7148NB/CW CB	220
SE7135CW/BK	209	SE7148NB/WW BK	220
SE7135CW/SL	209	SE7148NB/WW CB	220
SE7135WW/BK	209	SE7148WW/BK	220
SE7135WW/SL	209	SE7148WW/CB	220
SE7136CW/BK	209	SE7174/10DL/BK	190
SE7136CW/SL	209	SE7174/10DL/SL	190
SE7136WW/BK	209	SE7174/10WW/BK	190
SE7136WW/SL	209	SE7174/10WW/SL	190
SE7137CW/BK	209	SE7174/20DL/BK	190
SE7137CW/SL	209	SE7174/20DL/SL	190
SE7137WW/BK	209	SE7174/20WW/BK	190
SE7137WW/SL	209	SE7174/20WW/SL	190
SE7138CW	209	SE7174/30DL/BK	190
SE7138WW	209	SE7174/30DL/SL	190
SE7139CW	209	SE7174/30WW/BK	190
SE7139WW	209	SE7174/30WW/SL	190
SE7140CW/BK	211	SE7174/50DL/BK	191
SE7140CW/SL	211	SE7174/50DL/SL	191
SE7140WW/BK	211	SE7174/50WW/BK	191
SE7140WW/SL	211	SE7174/50WW/SL	191
SE7141CW/BK	211	SE7174/100DL/BK	191
SE7141CW/SL	211	SE7174/100DL/SL	191
SE7141WW/BK	211	SE7174/100WW/BK	191
SE7141WW/SL	211	SE7174/100WW/SL	191
SE7142CW/BK	211	SE7188/80/20CW	223
SE7142CW/SL	211	SE7188/110/25CW	223
SE7142WW/BK	211	SE7188/110/34CW	223
SE7142WW/SL	211	SE7188/150/42CW	223
SE7145CW/BK	217	SE7188/150/49CW	223
SE7145CW/SL	217	SE7188/150/62CW	223
SE7145WW/BK	217	SE7199/100NDL/BK	195
SE7145WW/SL	217	SE7199/100WW/BK	195
SE7146CW/BK	218	SE7199/200NDL/BK	195
SE7146CW/CB	218	SE7199/200WW/BK	195
SE7146WW/BK	218	SE7199/250NDL/BK	195
SE7146WW/CB	218	SE7199/250WW/BK	195
SE7147CW/BK	219	SE7250 BK	196
SE7147CW/CB	219	SE7250 SL	196
SE7147WW/BK	219	SE7250 WH	196
SE7147WW/CB	219	SE7251 BK	196
SE7148CW/BK	220	SE7251 SL	196

# INDEX

SE7251 WH	196	SHP200/120NDL/BK	250
SE7252 BK	196	SHP200/120NDL/CB	250
SE7252 SL	196	SHP200/240NDL/BK	250
SE7252 WH	196	SHP200/240NDL/CB	250
SE7253 BK	197	SHP205/75RC	249
SE7253 SL	197	SHP205/75RCS	248
SE7253 WH	197	SHP205/75SM	248
SE7254 BK	197	SHP205/110RC	249
SE7254 SL	197	SHP205/110RCS	248
SE7254 WH	197	SHP205/110SM	248
SE7255 BK	197	SHP205/150RC	249
SE7255 SL	197	SHP205/150RCS	248
SE7255 WH	197	SHP205/150SM	248
SE7273 BK	198	SHP305/70CW/BK	255
SE7273 WH	198	SHP305/90CW/BK	255
SE8001NDL	233	SHP305/120CW/BK	255
SE8001WW	233	SHP305/150CW/BK	255
SE8002NDL	234	SHP305/180CW/BK	255
SE8002P/NDL	234	SHP306/30CW/BK	255
SE8002P/WW	234	SHP306/50CW/BK	255
SE8002WW	234	SHP306/70CW/BK	255
SE8003RGB	235	SHP306/90CW/BK	255
SE8003RGB/P	235	SL2105/20DL	74
SELK1500ISF	287	SL2105/20WW	74
SELK2500/SM	286	SL2105/30DL	74
SES7060NDL/BK	186	SL2105/30WW	74
SES7080/1 DL BK	185	SL2105/40DL	74
SES7080/1 WW BK	185	SL2105/40WW	74
SES7080/2 DL BK	185	SL2106/20TC	76
SES7080/2 WW BK	185	SL2106/30TC	76
SES7090/2DL/BK	187	SL2106/30TC/S	76
SES7090/2WW/BK	187	SL2106/30TC/S	77
SFD23/150D	246	SL2106/30TC/S1	77
SFD23/230D	246	SL2106/30TC/S2	77
SFL018WW	97	SL2106/40TC	76
SGU9000LH	291	SL2106/40TC/C	76
SGU9000LH	291	SL2106/40TC/C	77
SHB22/140D/DL	245	SL2106/40TC/C1	77
SHB22/140DL	245	SL2106/40TC/C2	77
SHB22/240D/DL	245	SL2108DL	78
SHB22/240DL	245	SL2108WW	78
SHB23/150D	246	SL2110/10CW	85
SHB23/230D	246	SL2110/20CW	85
SHL008	291	SL2110/30CW	85

# INDEX

SL2110/40CW	85	SL7267 SL	206
SL2110/50CW	85	SL7267 SLS	206
SL2111/25CW/SL	79	SL7268 BK	207
SL2111/30CW/SL	79	SL7268 SA	207
SL2111/40CW/SL	79	SL7268 SL	207
SL3147/28CW	87	SL7268 SLS	207
SL3147/35CW	87	SL7269DL BK	199
SL3147/306 CW	87	SL7269DL WH	199
SL3147/312 CW	87	SL7270DL BK	199
SL3247/25CW	75	SL7270DL WH	199
SL3247/30CW	75	SL7362WW/SLS	236
SL3247/35CW	75	SL9706/280TC	123
SL3247/40CW	75	SL9706/540TC	123
SL7221GU AS	215	SL9706/840TC	123
SL7221GU BK	215	SL9706/1140TC	123
SL7221GU SL	215	SL9706/1440TC	123
SL7222GU AS	215	SL9707/60TC	112
SL7222GU BK	215	SL9707/120TC	112
SL7222GU SL	215	SL9709/60TC	113
SL7223WW/BK	216	SL9709/120TC	113
SL7223WW/SL	216	SL9712/40 BK	200
SL7224WW/BK	216	SL9712/40 SL	200
SL7224WW/SL	216	SL9712/40 WH	200
SL7261 AS	228	SL9712 BL	200
SL7261 BK	228	SL9712 CH	200
SL7261 SL	228	SL9712 SL	200
SL7261 SLS	228	SL9712 WH	200
SL7262 BK	206	SL9719RD	201
SL7262 SA	206	SL9719SQ	201
SL7262 SL	206	SL9721/20W DL	243
SL7262 SLS	206	SL9721/20W WW	243
SL7263 BK	207	SL9721/35W DL	243
SL7263 SA	207	SL9721/35W WW	243
SL7263 SL	207	SL9726/20TC	244
SL7263 SLS	207	SL9726/40TC	244
SL7264/40-1 BK	228	SL9732/20DL	116
SL7264/40-1 SL	228	SL9732/20TC	116
SL7264/40-1 SLS	228	SL9732/40CW	116
SL7264/40-2 BK	228	SL9732/40DL	116
SL7264/40-2 SL	228	SL9732/40TC	116
SL7264/40-2 SLS	228	SLA7102BK	231
SL7266WW/BK	227	SLA7102SL	231
SL7267 BK	206	SLB23/150D	246
SL7267 SA	206	SLB23/230D	246

# INDEX

SLC21/CW	280	SO2101/40 SC	80
SLC21/DL	280	SO2101/40 WH	80
SLC21/WW	280	SO2107	78
SLC30/CW	280	SO3000/30CW	82
SLC30/DL	280	SO3000/40CW	82
SLC30/WW	280	SO3109/30	81
SLD2000CW	114	SO3109/30 LED	81
SLD4000CW	114	SO3109/40	81
SLT1000	172	SO3109/40 LED	81
SLT3000	172	SO3160/30	86
SLT3010	172	SO3160/45	86
SLT3020	172	SO3700/30L DL	70
SLT3030	172	SO3700/30L TC	70
SLT3040	173	SO3700/40L DL	70
SLT3050	173	SO3700/40L TC	70
SLT4050	173	SO3701/30L TC	71
SLT5000	173	SO3701/40L TC	71
SLT6000	173	SO3800/40TC	73
SLT6010	173	SO3800/40TC/EM	73
SLT6050	173	SO3800/40TC/EMS	73
SMS731CS	300	SO3800/40TC/S	73
SMS731LC	300	SPK1000 DL BK	182
SMS731LP	300	SPK2000 DL BK	182
SMS731WS	300	SPL015	88
SMS800	293	SPL016	89
SMS801WF	295	SPL018	90
SMS802WR	296	SPL019	91
SMS803CD	297	SPL020WW30	92
SMS804CR	298	SPL020WW45	92
SMS805CS	299	SPL3000/30CW	83
SMS810	294	SPL3000/40CW	83
SMT9017CW/WH	157	SPL3100/64	96
SMT9017DL/WH	157	SPL3100/84	96
SMT9017WW/WH	157	SPL3200/2R	94
SO2101/30 AB	80	SPL3200/3R	94
SO2101/30 CH	80	SPL3200/46	94
SO2101/30 GD	80	SPL3200/60	94
SO2101/30 LED	80	SPL3200/81	94
SO2101/30 SC	80	SPL9017CW/WH	93
SO2101/30 WH	80	SPL9017DL/WH	93
SO2101/40 AB	80	SPL9017WW/WH	93
SO2101/40 CH	80	SPSK1000 DL BK	183
SO2101/40 GD	80	SPSK2000 DL BK	183
SO2101/40 LED	80	SRC9017CW/WH	157

# INDEX

SRC9017DL/WH	157	STG/112 DL	120
SRC9017WW/WH	157	STG/112 WW	120
SSI1512	138	STG/206 CW	120
SSI1512	144	STG/206 DL	120
SSI1512	292	STG/206EM2500	120
SSY1512	138	STG/206 WW	120
SSY1512	292	STG/212 CW	120
ST105	286	STG/212 DL	120
ST150	286	STG/212EM2500	120
ST200	286	STG/212 WW	120
ST300	286	STR3/4863GU BK	155
ST400	286	STR3/4863GU WH	155
STB/106 CW	118	STR3/9017CW/WH	156
STB/106 DL	118	STR3/9017DL/WH	156
STB/106 WW	118	STR3/9017WW/WH	156
STB/112 CW	118	STR4800/1 BK	144
STB/112 DL	118	STR4800/1 SL	144
STB/112 WW	118	STR4800/1 WH	144
STB/206 CW	118	STR4800/2 BK	144
STB/206 DL	118	STR4800/2 SL	144
STB/206EM2500	118	STR4800/2 WH	144
STB/206 WW	118	STR4801 BK	144
STB/212 CW	118	STR4801 SL	144
STB/212 DL	118	STR4801 WH	144
STB/212EM2500	118	STR4802 BK	144
STB/212 WW	118	STR4802 SL	144
STD/106 CW	119	STR4802 WH	144
STD/106 DL	119	STR4803 BK	144
STD/106 WW	119	STR4803 SL	144
STD/112 CW	119	STR4803 WH	144
STD/112 DL	119	STR4804 BK	144
STD/112 WW	119	STR4804 SL	144
STD/206 CW	119	STR4804 WH	144
STD/206 DL	119	STR4805 BK	144
STD/206EM2500	119	STR4805 SL	144
STD/206 WW	119	STR4805 WH	144
STD/212 CW	119	STR4806 BK	144
STD/212 DL	119	STR4806 SL	144
STD/212EM2500	119	STR4806 WH	144
STD/212 WW	119	STR4808 BK	144
STG/106 CW	120	STR4808 SL	144
STG/106 DL	120	STR4808 WH	144
STG/106 WW	120	STR4855L BK	146
STG/112 CW	120	STR4855L SL	146

# INDEX

STR4855L WH	146	STR4897 WH	150
STR4856L BK	146	STR4898 BK	150
STR4856L SL	146	STR4898 WH	150
STR4856L WH	146	STR4899/1 BK	150
STR4861WW/BK	148	STR4899/1 WH	150
STR4861WW/WH	148	STR4899/2 BK	150
STR4863GU BK	147	STR4899/2 WH	150
STR4863GU WH	147	STR4899/3 BK	150
STR4863LV WH	147	STR4899/3 WH	150
STR4866CW/BK	149	STR9017CW/WH	156
STR4866CW/WH	149	STR9017DL/WH	156
STR4866WW/BK	149	STR9017WW/WH	156
STR4866WW/WH	149	SW2101 AB	80
STR4881/30BK CW 24 DG	152	SW2101 CH	80
STR4881/30BK WW 24 DG	152	SW2101 GD	80
STR4881/30WH CW 24 DG	152	SW2101 SC	80
STR4881/30WH WW 24 DG	152	SW2101 WH	80
STR4881/50BK CW 24 DG	152	SW3109	81
STR4881/50BK WW 24 DG	152	SWL350BT	305
STR4881/50WH CW 24 DG	152		
STR4881/50WH WW 24 DG	152		
STR4882/36 BK WW	153		
STR4882/36 WH WW	153		
STR4883WW/BK	153		
STR4883WW/WH	153		
STR4886WW/BK	154		
STR4886WW/WH	154		
STR4890/1 BK	150		
STR4890/1 WH	150		
STR4890/2 BK	150		
STR4890/2 WH	150		
STR4891 BK	150		
STR4891 WH	150		
STR4892 BK	150		
STR4892 WH	150		
STR4893 BK	150		
STR4893 WH	150		
STR4894 BK	150		
STR4894 WH	150		
STR4895 BK	150		
STR4895 WH	150		
STR4896 BK	150		
STR4896 WH	150		
STR4897 BK	150		



